



Hazen and Sawyer
1000 N Ashley Drive, Suite 1000
Tampa, FL 33602 • 813.630.4498



Evaluation of Exhibit D Water Quality

Final Report
Tampa Bay Water PO 20190150-00
Hazen Project 41089-000
December 5, 2019

Table of Contents

Executive Summary	V
1. Introduction	1-1
1.1 Background.....	1-1
1.1.1 Regional System and Treatment Facility Overview	1-3
1.1.2 Exhibit D Water Quality Criteria Background.....	1-8
1.1.3 Potential Exhibit D Changes	1-8
1.2 Objectives	1-9
1.3 Scope of Work	1-10
2. Data Evaluation	2-1
2.1 Approach.....	2-1
2.2 Data Summary	2-5
2.2.1 Existing Data.....	2-5
2.2.2 Level-1 Grouping	2-6
2.2.3 Level-2 Grouping	2-9
2.2.4 Level-3 Test Locations.....	2-12
2.3 Data Analysis	2-14
3. System Model Development	3-1
3.1 Selected Water Quality Parameters	3-1
3.2 Source Water Quality Variability	3-2
3.3 POC Water Quality Variability.....	3-2
4. Predicted Treatment Requirements	4-1
4.1 Location and Estimated Percent Removal.....	4-1
4.2 Potential Treatment Processes.....	4-3
5. Opinion of Probable Construction Costs and Phasing Considerations	5-1
5.1 Assumptions	5-1
5.2 Summary of Costs to Meet Water Quality Goals (Without Hardness).....	5-3
5.3 Additional Costs to Meet Proposed Exhibit D Calcium Hardness Goal.....	5-6
5.4 Phasing Consideration.....	5-7
5.5 Preliminary Cost-Benefit Analysis.....	5-8

6. Summary of Findings and Next Steps 6-10

List of Tables

Table 1-1 Comparison of Exhibit D Limits with accompanying FDEP Limits 1-2
 Table 1-2: Existing Tampa Bay Water Treatment Facilities 1-3
 Table 1-3: Existing and Proposed Exhibit D Water Quality Parameter limits 1-9
 Table 2-1: Example Breakdown Showing Percentage of Wells Using Option 1, 2, or 3 for Modeled Water Quality 2-5
 Table 2-2: Sampling Analysis..... 2-6
 Table 2-4: Identified Annual Average TOC Targets 2-15
 Table 3-1: Selected Exhibit D Parameters for Further Study 3-1
 Table 3-3: Wells Removed in Future Scenarios 3-4
 Table 4-1: Identified Treatment Scenarios 4-1
 Table 4-2: Location and TOC Percent Removal Requirements 4-2
 Table 4-3: Estimated Calcium Hardness Removal Requirements 4-2
 Table 4-4: Proposed Treatment Technologies and Performance Assumptions 4-3
 Table 4-5: Summary of Selected Treatment Technologies..... 4-4
 Table 5-1: Preliminary Design Criteria Summary 5-3
 Table 5-2: Summary of Planning Level Costs for Each Scenario 5-3
 Table 5-3: Cost Scenario A – 2.0 mg/L TOC Target..... 5-4
 Table 5-4: Cost Scenario B – 1.5 mg/L TOC Target..... 5-4
 Table 5-5: Cost Scenario C – 1.25 mg/L TOC Target..... 5-5
 Table 5-6: Cost Scenario D – 1.0 mg/L TOC Target..... 5-6
 Table 5-7: Summary of Estimated Calcium Removal Costs 5-7
 Table 5-8: Potential Phasing and Capital Cost Distribution (Without Hardness) 5-8
 Table 5-9: Scenario Based Cost-Benefit Analysis..... 5-9
 Table 6-1: Summary of Water Quality Benefits 6-10
 Table 6-2 Approximate Timing of Next Steps 6-11

List of Figures

Figure 1-1: Map of Tampa Bay Water’s Existing System..... 1-5
 Figure 1-2: Conceptual System Diagram..... 1-7
 Figure 2-2: Graphic Representation of Well Grouping Process 2-4
 Figure 2-3: Basis for determining the modeled water quality for each source 2-4
 Figure 2-4: Well Grouping Analysis Total Organic Carbon (mg/L) & Chloride (mg/L)..... 2-7
 Figure 2-5: Well Grouping Analysis Iron (mg/L)..... 2-7
 Figure 2-6: Level-1 TOC results..... 2-8
 Figure 2-7: Comparison on FEEM for (A) ELW103 and (B) ELW116..... 2-9
 Figure 2-8: Level-2 Results Showing Strong Linear Correlation Between TOC and THMFP. 2-10
 Figure 2-9: Level-2 Specific THMFP (ppb THMFP per mg/L TOC) 2-10
 Figure 2-10: Level-2 Specific UV-254 Absorbance (L/mg-m) 2-11

Figure 2-11: Level-3 Testing Free Chlorine Decay Curves..... 2-12
 Figure 2-12: Level-3 Testing Chloramine Decay Curves..... 2-13
 Figure 2-13: Level-3 Testing Free Chlorine SDS Curves 2-13
 Figure 2-14: Level-3 Testing Chloramine SDS Curves..... 2-14
 Figure 2-15: Relationship between Level-3 TOC, Incubation Time, and SDS TTHM based on
 free chlorine residual 2-15

List of Appendices

- Appendix A: 2017 Member Government Recommendations
- Appendix B: Level-1 Well Sampling Protocol
- Appendix C: Level-2 THMFP Test Protocol
- Appendix D: Level-3 SDS Test Protocol
- Appendix E: System Model Results
- Appendix F: Level-1 & Level-2 Groups
- Appendix G: System Model Water Quality Assumptions
- Appendix H: Water Supply Contract
- Appendix I: Summary of Study Water Quality Results

List of Acronyms

Abbreviation	Definition
BAC	Biological activated carbon
BUD	Brandon Urban Wellfield
CB	Cross Bar Wellfield
CC	Cypress Creek Wellfield
CO	Cosme-Odessa Wellfield
CY	Cypress Bridge Wellfield
ELW	Eldridge Wilde Wellfield
FEEM	Fluorescent-excitation-emission-matrices
MAY	Maytum
MB	Morris Bridge Wellfield
MCL	Maximum contaminant limit
NWH	Northwest Hillsborough
O&M	Operation and maintenance
POC	Point of connection

Abbreviation	Definition
RPOE	Regional Point of Entry
RSWTP	Regional Surface Water Treatment Plant
S-21	Section 21 Wellfield
SCH	South Central Hillsborough Wellfield
SDS	Simulated distribution system
SP	South Pasco Wellfield
ST	Starkey Wellfield
TDS	Total dissolved solids
TOC	Total organic carbon

Executive Summary

Introduction

Tampa Bay Water is a regional wholesale water provider for six member governments: Hillsborough County, Pinellas County, Pasco County, and the cities of Tampa, St. Petersburg, and New Port Richey. Tampa Bay Water operates a diversified water supply including groundwater, surface water, and seawater sources. The Master Water Supply Contract with the member governments requires Tampa Bay Water to deliver similar water quality at all Points of Connection. Exhibit D, which defines the expected water quality criteria at the regional Point of Connection, is an attachment to the Master Water Supply Contract, which was approved in 1998 at the same time as the agency's Amended and Restated Interlocal Agreement. Section 2 of the Master Water Supply Contract contemplated Exhibit D would be modified from time to time to address changes in regulations or customer demands. In 2004 Exhibit D was modified to its present form following years of monitoring and study, including significant pilot testing.

Water that meets these criteria is defined as Quality Water, which Tampa Bay Water consistently meets at each Point of Connection. Quality Water is drinking water that meets primary and secondary drinking water standards as defined by the United States Environmental Protection Agency Safe Drinking Water Act (SDWA) promulgated in Florida by the Department of Environment (FDEP), plus additional requirements and limitations not included in the SDWA-based regulations. For example, the fluoride limit in Exhibit D has more stringent numeric limit than the SDWA-based regulations, also referred as maximum contaminant limits (MCLs). Exhibit D also requires more frequent monitoring/testing than the SDWA-based regulations. This is because the concentration limits for each parameter are assessed against the analytical results from a twelve-month running annual average sampling program. Exhibit D also includes additional parameters with numeric limits, which are not required by the SDWA, including conductivity, temperature, total sulfide, ammonia, alkalinity, total hardness, calcium hardness, orthophosphate, and total organic carbon. A comparison of SDWA limits as applied by the Florida Department of Environment (FDEP) and Exhibit D limits are shown in Table ES-1.

Table ES-1: Comparison of Exhibit D Limits with accompanying FDEP Limits

Parameter	Exhibit D Limit	FDEP SDWA Limit	
		Primary MCL	Secondary MCL
TOC	4.6 mg/l max average 6.5 mg/l max	N/A	N/A
Color	15 CU max	N/A	15 CU
Iron	0.3 mg/l max average	N/A	0.3
pH	7.0 min average	N/A	6.5-8.5
Sulfide	0.1 mg/l max average	N/A	N/A
TDS	500 mg/l max average	N/A	500
Nitrate	10.0 mg/L max average	10	N/A
Nitrite	1.0 mg/l max average	1.0	N/A
Calcium Hardness	50 mg/L as CaCO ₃ min average 250 mg/L as CaCO ₃ max average	N/A	N/A
Hardness	300 mg/L as CaCO ₃ min average	N/A	N/A
Ammonia	1.0 mg/L N max average	N/A	N/A
Chlorine Demand	N/A	N/A	N/A
DBP Formation Potential	N/A	N/A	N/A
Odor (TON)	N/A	N/A	N/A
Conductivity	850 umhos/cm max average	N/A	N/A
Temperature	35 degrees C max average	N/A	N/A
Alkalinity	100 mg/L as CaCO ₃ min average	N/A	N/A
Turbidity	1.0 NTU max average	1.0*	N/A
Fluoride	0.8 mg/L as F max average	4.0	2.0
Ortho P	1.0 mg/L as P max average	N/A	N/A
Sulfate	250 mg/L max average	N/A	250
Chloride	250 mg/L max average	N/A	250 mg/L

*The turbidity limit is established as part of the surface water treatment rule promulgated by FDEP.

Compliance with Exhibit D establishes a common regional baseline for water quality because Tampa Bay Water as a wholesale supplier has no jurisdiction beyond the Point of Connection within the member government distribution systems. Water quality in the distribution systems remains the exclusive responsibility of the member governments (i.e. member governments have unique distribution system characteristics of age, pipe, water age, etc. and accordingly practice unique corrosion control and other elective practices including softening and fluoridation.). This allows each member government to pay for any specific water quality adjustments within its particular distribution system, eliminating the need for member governments to pay for the unique water quality benefits for other member governments if implemented as part of the regional system.

While today's water quality is the highest ever delivered to Tampa Bay Water's customers, meeting or surpassing federal, state and Exhibit D standards, it is beneficial and logical to examine whether water quality improvements can be made to better serve the member governments and the region, recognizing it has been more than a decade since the last in-depth examination.

In 2017, the member governments requested that Tampa Bay Water evaluate several of the water quality parameters within Exhibit D to improve water quality, which may enhance water quality within the member governments' distribution systems. The motivation for the potential changes is based on a more consistent delivery of a higher quality water that would lead to improving the stability of the disinfectant residual and further reducing disinfection byproduct formation (DBPs) in the member government distribution systems. Additional benefits of enhanced water quality include potential reductions in nitrification events, flushing volumes within the distribution systems, and potential taste and odor events. Table ES-2 summarizes the existing Exhibit D water quality limits and future water quality goals that are evaluated in this report.

Table ES-2: Exhibit D Existing and Proposed Water Quality Goals

Parameter	Member Government Priority	Existing Limit	Proposed Goal
TOC	1	4.6 mg/l max average 6.5 mg/l max	1.0 mg/L max average 2.0 mg/L max
Color	2	15 CU max	5 CU max
Iron	3	0.3 mg/l max average	0.05 mg/l max average
pH	4	7.0 min average	7.8 - 8.3
Sulfide	4	0.1 mg/l max average	0.02 mg/l max average
TDS	4	500 mg/l max average	400 mg/l max average
Nitrate	4	10.0 mg/L max average	0.4 mg/L max average
Nitrite	4	1.0 mg/l max average	0.05 mg/l max average
Calcium Hardness	4	50 mg/L as CaCO ₃ min average 250 mg/L as CaCO ₃ max average	100 mg/L as CaCO ₃ max average
Hardness	4	300 mg/L as CaCO ₃ min average	150 mg/L as CaCO ₃ min average
Ammonia	4	1.0 mg/L N max average	0.02 mg/L N max average
Chlorine Demand	5	N/A	Add
DBP Formation Potential	5	N/A	Add
Odor (TON)	5	N/A	3
Conductivity	N/A	850 umhos/cm max average	850 umhos/cm max average
Temperature	N/A	35 degrees C max average	35 degrees C max average
Alkalinity	N/A	100 mg/L as CaCO ₃ min average	100 mg/L as CaCO ₃ min average
Turbidity	N/A	1.0 NTU max average	1.0 NTU max average
Fluoride	N/A	0.8 mg/L as F max average	0.8 mg/L as F max average
Ortho P	N/A	1.0 mg/L as P max average	1.0 mg/L as P max average
Sulfate	N/A	250 mg/L max average	250 mg/L max average
Chloride	N/A	250 mg/L max average	250 mg/L max average

The objective of this study is to characterize source water quality, prioritize treatment locations, identify potential treatment approaches, benefits, and the associated costs for treatment. Total organic carbon (TOC) is a priority 1 parameter, and removal was assumed to be the driving factor for costs, and thus was used as the primary parameter for treatment target development. Color, total dissolved solids, ammonia, and hardness were excluded from the water blending model analysis as they were either already addressed by TOC treatment technologies, the sources already met the proposed goals, or treatment was not cost-effective. Iron, pH, sulfide, nitrate, and nitrite treatment goals were grouped together with TOC treatment for the cost development separately from calcium hardness. Due to the potential significant cost impact of calcium hardness treatment and its lower priority, this parameter's treatment cost estimate was assessed separately as an add-on cost.

Data Evaluation

Based on a historical review and evaluation of existing and supplemental data, a detailed model of the system was developed to estimate target TOC values at the points of connection, which are summarized in Table ES-3. Since TTHM formation is a function of both TOC concentration and time, these TOC targets represented different estimated residence times where the TTHM concentration would remain below 80 ppb.

Table ES-3: Selected Annual Average TOC Targets

TOC Target (mg/L)	Basis for Target ⁽¹⁾	
	Approx. TTHM Concentration ⁽²⁾	Approx. Residence Time in Distribution System under free chlorine
2.00	< 80 ppb	< 3 days
1.50	< 80 ppb	3 to 5 days
1.25	< 80 ppb	5 to 7 days
1.00 ⁽³⁾	< 80 ppb	>7 days

1. Predicted TTHM concentration for a given incubation time based on analyzed SDS data.
2. TTHM or Total Trihalomethanes is a class of the disinfection byproducts (DBPs)
3. Member government requested max average proposed goal

The four annual average TOC targets at each Point of Connection were utilized in the water blending model to determine the TOC and other water quality treatment requirements for the various source waters that supply the Points of Connections. The evaluated scenarios are summarized in Table ES-4, which were used to identify the required level of treatment at each source to achieve the targets at the Points of Connections.

Table ES-4: Identified Treatment Scenarios

Scenario A	Scenario B	Scenario C	Scenario D
2.0 mg/L TOC	1.5 mg/L TOC	1.25 mg/L TOC	1.0 mg/L TOC
Common Treatment Goals Among Scenarios			
Iron – 0.05 mg/L Sulfide – 0.02 mg/L	Nitrate – 0.4 mg/L-N Nitrite – 0.05 mg/L-N	Calcium – 100 mg/L as CaCO ₃	pH – 7.8 – 8.3

Estimated Treatment Requirements

It was assumed that treatment would be applied to sources rather than the POC. Treating at the source allowed for treatment selection that was tailored for the water quality conditions unique to each source. For example, if a POC was fed from three sources, but only one source had sulfide, then sulfide treatment could be applied to that specific source rather than sizing sulfide treatment for the entire flow at the POC,

which would increase the overall cost. This source-treatment approach allowed for increased flexibility in process selection, while ultimately focusing on the water quality at the POC which was often a blend of multiple sources.

Treatment technologies were selected to meet the removal requirements based on typical performance assumptions and suitability for each source’s needs. The initial focus of treatment selection was based on removal of TOC to achieve the targets in Table ES-3 while addressing the proposed iron, pH, sulfide, nitrate, and nitrite levels. Calcium hardness treatment was evaluated separately since this was a lower priority parameter and has a significant impact on the overall costs. Table ES-5 presents the opinion of probable capital, operation and maintenance (O&M), and present worth costs for each source based on the selected treatment technologies and the additional costs associated with calcium hardness reduction. Further, if calcium hardness treatment goals are changed, any potential impacts on the member government corrosion control strategy would need to be further evaluated.

Table ES-5: Opinion of Probable Capital and O&M Costs

Scenario	Treatment Cost			Calcium Hardness Only		
	Capital Cost (\$)	Annual O&M Cost (\$)	Present Worth Cost (\$) ⁽¹⁾	Capital Cost (\$)	Annual O&M Cost (\$)	Present Worth Cost (\$)
A	\$126 M	\$5.0 M	\$198 M	\$92 M	\$8.0 M	\$198 M
B	\$166 M	\$10 M	\$305 M			\$198 M
C	\$192 M	\$11 M	\$360 M			\$198 M
D	\$208 M	\$13 M	\$405 M			\$198 M

1. Present worth costs were calculated assuming 30-year period at 6 percent interest.

A summary of the estimated annualized costs, potential waste streams from the identified treatment processes, and the potential impacts on member government flushing volumes and costs are included in Table ES-6.

Table ES-6: Summary of Estimated Costs and Impacts on Waste Stream Generation & Flushing

Scenario	Estimated Amortized Total Treatment Cost ⁽¹⁾ (\$/yr)		Estimated Waste Stream Generation (MG/yr)		Potential Benefit Reduced Flushing	
	Parameters (except Ca+) ⁽²⁾	Calcium Hardness Only ⁽³⁾	Parameters (except Ca+) ⁽²⁾	Calcium Hardness Only ⁽³⁾	Volume Reduction (MG/yr)	Cost Savings (\$/yr)
A	\$14 M	\$15 M	600	580	450	\$1.1 M
B	\$22 M	\$15 M	720	580	580	\$1.4 M
C	\$25 M	\$15 M	950	580	760	\$1.9 M
D	\$29 M	\$15 M	1,130	580	900	\$2.3 M

1. Amortized costs represent the summation of capital and operation and maintenance costs spread over a 30-year period at 6 percent interest.
2. Treatment for all water goals with the exception of calcium hardness
3. Additional costs to incorporate calcium hardness treatment.
4. Additional waste stream volume generation due to calcium hardness treatment.

Recommendation and Next Steps

Table ES-7 summarizes the overall potential water quality benefits for each scenario as TOC levels are reduced.

Table ES-7: Summary of Potential Water Quality Benefits

Scenario	Potential Water Quality Benefits ⁽¹⁾				
	Residual Stability	THM Formation	Taste & Odor ⁽²⁾	Nitrification Potential	Hardness
A					
B					
C					
D					

1. Full green circle represents maximum benefit and quarter green circle represents minimum benefit.
2. Taste and odor impacts are not exclusively tied to TOC reduction; however, some TOC removal processes also address sources of taste and odor.

While ES-7 describes benefits qualitatively, results which demonstrate quantitative benefits are shown in the main report. Figure 2-11 and Figure 2-12 illustrate quantitative benefits related to chlorine and chloramine decay rates, while Figure 2-13 and Figure 2-14 illustrate quantitative benefits related to THM formation potential.

In general, the following are the potential overall water quality benefits based on the findings from the study:

- Reducing TOC is expected to improve water quality and provide a more consistent supply throughout the region, reducing the need for additional treatment (i.e. disinfection boost) by each member government in response to TOC and other water quality variables.
- Improving regional water quality should help the member governments manage water quality in their distribution systems by increasing the residual stability and reducing potential for taste and odor, while decreasing flushing due to both TOC and nitrification.
- Lower TOC levels will reduce DBP formation during free chlorine burns or if a free chlorine residual is maintained within the system.
- The extent of water quality improvements increases as the TOC level is reduced.

Based on the findings of this study and the overall approach, the following are the recommended next steps:

- Collect additional water quality data needed to update the system model and assumptions.
- Confirm residence times in member government distribution systems to verify potential impacts on trihalomethane formation.
- Continue to refine the model by collecting additional water quality data to confirm basic assumptions.
- Perform bench/pilot studies on the potential treatment technologies to confirm the design criteria and costs.
- Further evaluate ability to phase the level of treatment and impact on required timing of treatment.
- Further evaluate any potential impacts on member government corrosion control strategies.

It is recommended that these next steps be completed before finalizing treatment locations and technologies. Once finalized and approved, treatment would be installed in phases at the recommended locations to demonstrate success under various source water conditions before modifying Exhibit D. Table ES-8 summarizes the anticipated activities and approximate timing of these future activities.

Table ES-8: Approximate Timing of Next Steps ⁽¹⁾

Action Item	Estimated Completion Date
Board Approved Study and Next Steps	December 2019
Complete additional studies, including sampling, confirmation of residence times, and bench/pilot tests	December 2020
Confirm/finalize treatment locations and costs (update model)	June 2021
Board Approved Recommendations for Treatment Projects	December 2021
Design and Construction of Improvements ⁽²⁾	30 - 60 months from Board Authorization
Operational Period to Confirm Results	12 months after construction
Board Approved Modification of Exhibit D based on Findings	6 months after operational period

Note: 1. Schedule is contingent on study findings and necessary approvals.
 2. Depends on the extent and phasing of Board approved treatment

1. Introduction

1.1 Background

Tampa Bay Water is a regional wholesale water provider that delivers supply to its six member governments: Hillsborough County, Pinellas County, Pasco County, and the Cities of Tampa, St. Petersburg, and New Port Richey. Each delivery location or point of connection (POC) has requirements for water quality per the Master Water Supply Contract. Tampa Bay Water is also required to maintain service to meet projected demands at these POCs. Tampa Bay Water utilizes groundwater, surface water, and seawater sources and various treatment locations and technologies to consistently meet the Master Water Supply Contract requirements.

In 1998, the six member governments approved an amended version of the contract after more than a year of negotiations, which included the attachment of Exhibit D. Exhibit D, modified in 2004, states the criteria for Quality Water and provides avenues for revisions to address new regulatory guidelines or customer demands.

Quality Water is drinking water that meets primary and secondary drinking water standards as defined by the United States Environmental Protection Agency Safe Drinking Water Act (SDWA) promulgated in Florida by the Department of Environment (FDEP), plus additional requirements and limitations not included in the SDWA-based regulations. For example, the fluoride limit in Exhibit D has more stringent numeric limit than the SDWA-based regulations, also referred as maximum contaminant limits (MCLs). Exhibit D also requires more frequent monitoring/testing than the SDWA-based regulations. This is because the concentration limits for each parameter are assessed against the analytical results from a twelve-month running annual average sampling program. Exhibit D also includes additional parameters with numeric limits, which are not required by the SDWA, including conductivity, temperature, total sulfide, ammonia, alkalinity, total hardness, calcium hardness, orthophosphate, and total organic carbon. A comparison of SDWA limits as applied by the Florida Department of Environment (FDEP) and Exhibit D limits are shown in Table 1-1.

Table 1-1 Comparison of Exhibit D Limits with accompanying FDEP Limits

Parameter	Exhibit D Limit	FDEP SDWA Limit	
		Primary MCL	Secondary MCL
TOC	4.6 mg/l max average 6.5 mg/l max	N/A	N/A
Color	15 CU max	N/A	15 CU
Iron	0.3 mg/l max average	N/A	0.3
pH	7.0 min average	N/A	6.5-8.5
Sulfide	0.1 mg/l max average	N/A	N/A
TDS	500 mg/l max average	N/A	500
Nitrate	10.0 mg/L max average	10	N/A
Nitrite	1.0 mg/l max average	1.0	N/A
Calcium Hardness	50 mg/L as CaCO ₃ min average 250 mg/L as CaCO ₃ max average	N/A	N/A
Hardness	300 mg/L as CaCO ₃ min average	N/A	N/A
Ammonia	1.0 mg/L N max average	N/A	N/A
Chlorine Demand	N/A	N/A	N/A
DBP Formation Potential	N/A	N/A	N/A
Odor (TON)	N/A	N/A	N/A
Conductivity	850 umhos/cm max average	N/A	N/A
Temperature	35 degrees C max average	N/A	N/A
Alkalinity	100 mg/L as CaCO ₃ min average	N/A	N/A
Turbidity	1.0 NTU max average	1.0*	N/A
Fluoride	0.8 mg/L as F max average	4.0	2.0
Ortho P	1.0 mg/L as P max average	N/A	N/A
Sulfate	250 mg/L max average	N/A	250
Chloride	250 mg/L max average	N/A	250 mg/L

*The turbidity limit is established as part of the surface water treatment rule promulgated by FDEP.

Compliance with Exhibit D establishes a common regional baseline for water quality because Tampa Bay Water as a wholesale supplier has no jurisdiction beyond the Point of Connection within the member government distribution systems. Water quality in the distribution systems remains the exclusive responsibility of the member governments.

While today's water quality is the highest ever delivered to Tampa Bay Water's customers, meeting or surpassing federal, state and Exhibit D standards, it is beneficial and logical to examine whether water quality improvements can be made to better serve the member governments and the region, recognizing it has been more than a decade since the last in-depth examination.

In 2017, the member governments requested that Tampa Bay Water evaluate several of the water quality parameters within Exhibit D to improve water quality, which may enhance water quality within the member governments’ distribution systems. The motivation for the potential changes is based on a more consistent delivery of a higher quality water that would lead to improving the stability of the disinfectant residual and further reducing disinfection byproduct formation (DBPs) in the member government distribution systems. Additional benefits of enhanced water quality include potential reductions in nitrification events, flushing volumes within the distribution systems, and potential taste and odor events.

1.1.1 Regional System and Treatment Facility Overview

Tampa Bay Water has a diverse potable water supply, treatment, and conveyance system. Supply sources include twelve groundwater wellfields, surface water from the Hillsborough River, Alafia River and the Tampa Bypass Canal, and seawater from Tampa Bay. Existing sources and treatment facilities within Tampa Bay Water’s system are listed in Table 1-2. Other wellfield supply sources do not receive any treatment and deliver untreated groundwater to the POCs.

Table 1-2: Existing Tampa Bay Water Treatment Facilities

Source	Facility	Treatment Process or Chemical Feed System	Sustainable Capacity (mgd)
Tampa Bay	Tampa Bay Desalination Treatment Facility	Coagulation / Dynasand/ Diatomaceous Earth Filtration/ Reverse Osmosis/ Alkalinity Adjustment/ Chlorination	18-20
Alafia River	Tampa Bay Regional Surface Water Treatment Facility	Coagulation/ Actiflo / Ozone/ Biological Filters/ Chloramination	90
Hillsborough River			
Tampa Bypass Canal			
Reservoir			
Brandon Wells 2, 4, 5R, and 6	Brandon 5 Treatment Facility	Chloramination	4.5
Brandon Well 7	Brandon 7 Treatment Facility	Chloramination	1.5
South-Central Hillsborough Wellfield	Lithia H2S Removal Facility	Ozone oxidation	35
Morris Bridge Wellfield	Morris Bridge Treatment Facility	Chloramination	17.5
Cypress Bridge Wellfield	Lake Bridge Treatment Facility	Chloramination	17.5
Regional supply to Pasco County	Lake Bridge Treatment Facility	Chloramine trim and pH adjustment	17.5
Cypress Creek Wellfield	Cypress Creek Treatment Facility	Chloramination and pH adjustment	68.5
Cross Bar Ranch Wellfield			
Regional Supply	Cypress Creek Treatment Facility	Chloramine trim and pH adjustment	83
South-Pasco Wellfield	South Pasco Treatment Facility	Chloramination	20

Source	Facility	Treatment Process or Chemical Feed System	Sustainable Capacity (mgd)
Eldridge Wilde Wellfield	Keller H2S Removal Facility	Forced draft aeration	25
Northwest Hillsborough Wellfield	N/A	N/A	4.0
Section 21 Wellfield	N/A	N/A	4.0
Cosme-Odessa Wellfield	N/A	N/A	10
Starkey Wellfield	N/A	N/A	5.0

*N/A – Not applicable

Tampa Bay Water has a diverse network of regional transmission mains that deliver supply to the POCs. A map of Tampa Bay Water’s system is provided as Figure 1-1.

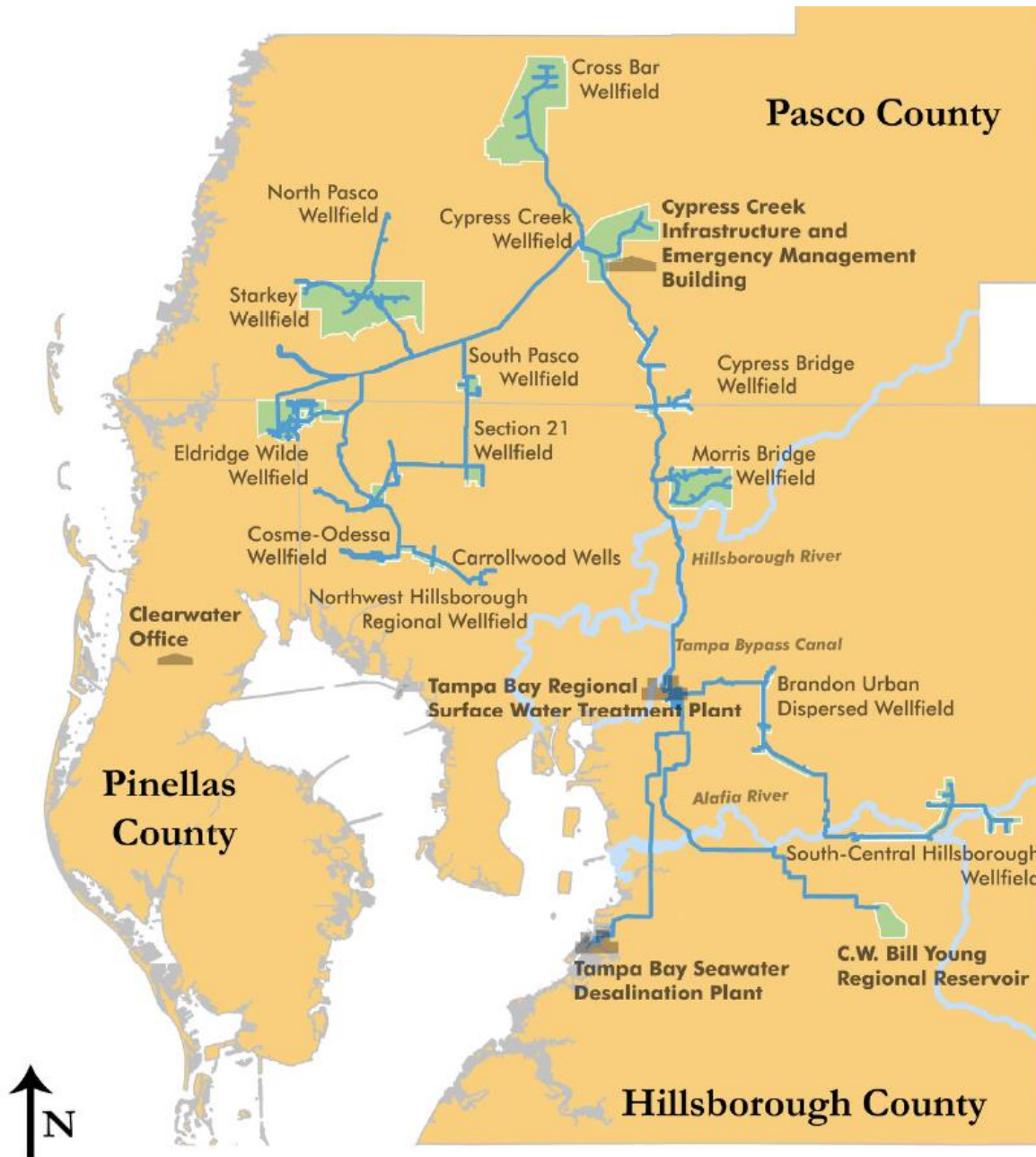

Figure 1-1: Map of Tampa Bay Water's Existing System

The terminology used to describe these supply sources and interconnects is as follows:

- **Individual Groundwater Well** refers to groundwater from an individual well prior to treatment (i.e. upstream of aeration, chlorination, filtration etc.).
- **Source** refers to waters from multiple wells within a given wellfield upstream of the point of entry to the Tampa Bay Water distribution system or point of connection. For the RSWTP or Desalination

Plant, this point would be represented as the treated surface or desalinated water leaving the leaving the facilities.

- **Regional Point of Entry (RPOE)** refers to the point at which a single source water enters the Tampa Bay Water regional transmission system or blends with other sources.
- **Regional Water** refers to finished, potable water being conveyed through the Tampa Bay Water Regional System.
- **Point of Connection (POC)** refers to the point at which system water is conveyed to a member government.

Figure 1-2 presents two generic examples of how water is blended from source(s) to each POC.

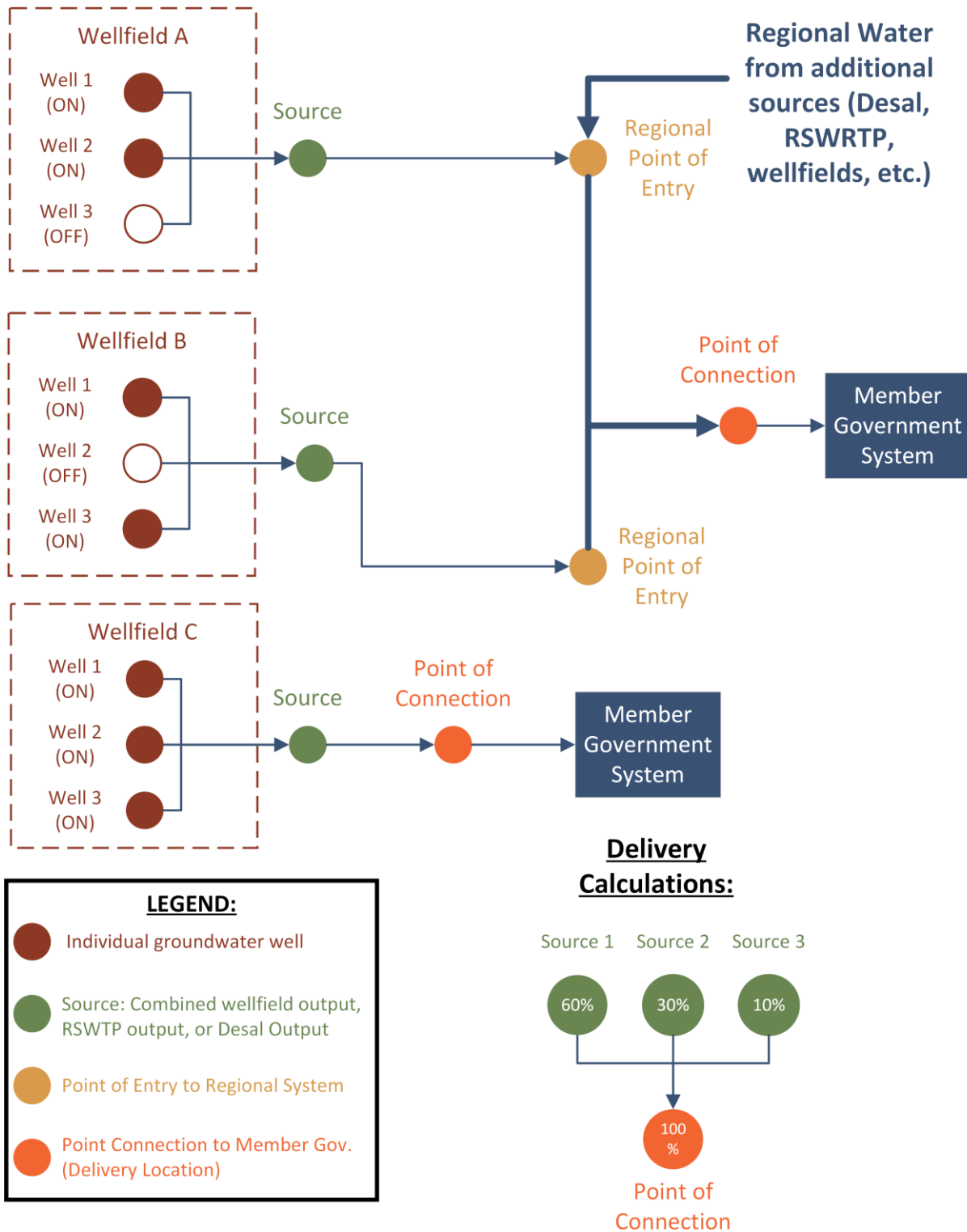

Figure 1-2: Conceptual System Diagram

1.1.2 Exhibit D Water Quality Criteria Background

Exhibit D is an attachment to the Master Water Supply Contract, which was approved in 1998 along with the agency's Amended and Restated Interlocal Agreement. At that time, the six member governments and their administrative heads and counsel negotiated Exhibit D to allow for periodic review of water quality limits to address changes in regulations or customer demands. Water that meets these criteria is referred to as Quality Water, which Tampa Bay Water consistently meets at each POC. Quality Water is defined as drinking water that meets primary and secondary drinking water standards as defined by the United States Environmental Protection Agency, plus three additional parameters for sulfides, total hardness and alkalinity. The concentration limits for each parameter are assessed against the analytical results from a twelve-month running annual average sampling program.

With the selection of alternative water supplies in the 1998 Master Water Plan, Tampa Bay Water investigated the best way to maintain a disinfectant residual in the system while meeting new, more stringent federal drinking water standards. Following a series of workshops with the Board and utility directors, chloramines were selected in 2001 as the preferred disinfectant and in May 2002, Tampa Bay Water changed its secondary disinfection to chloramines. Chloramines reduces the formation of disinfection byproducts, provides a cost-effective way to maintain regulatory compliance, reduces chlorine taste and smell, and provides a more stable, long-lasting disinfectant residual in the regional distribution system.

In 2004, after about two years operating the system with chloramines and after more than a year of operating with new surface water sources in the regional system, Tampa Bay Water and the member governments revised Exhibit D, adding and deleting some parameters, changing some parameter limits and adding a running annual average calculation from monthly sampling for parameter compliance. These Exhibit D changes were evaluated in detail as part of the Water Research Foundation Tailored Collaboration study, which looked at the effects of the new water sources on member government distribution systems.

1.1.3 Potential Exhibit D Changes

While today's water quality is the highest ever delivered to Tampa Bay Water's customers, meeting or surpassing federal, state and Exhibit D standards, it is beneficial and logical to examine whether water quality improvements can be made to better serve the member governments and the region, recognizing it has been more than a decade since the last in-depth examination. In 2017, the member governments requested that Tampa Bay Water evaluate several of the water quality parameters within Exhibit D to improve water quality, which may enhance water quality within the member governments' distribution systems. The motivation for the potential changes is based on a more consistent delivery of a higher quality water that would lead to improving the stability of the disinfectant residual and further reducing disinfection byproduct formation (DBPs) in the member government distribution systems. Additional benefits of enhanced water quality include potential reductions in nitrification events, flushing volumes within the distribution systems, and potential taste and odor events. Improved residual stability, which would reduce flushing volumes, is an anticipated benefit of operating with lower TOC. Both bulk chlorine decay would likely improve along with reduced nitrification. Operation under free chlorine would eliminate the potential for nitrification events.

The table in Appendix A lists the existing criteria, the requests from each member government, and the agreed upon “for study” values that were considered as part of this evaluation. Table 1-3 summarizes the prioritized water quality parameters that are addressed as part of this report.

Table 1-3: Existing and Proposed Exhibit D Water Quality Parameter limits

Parameter	Member Government Priority	Existing Limit	Proposed Goal
TOC	1	4.6 mg/l max average 6.5 mg/l max	1.0 mg/L max average 2.0 mg/L max
Color	2	15 CU max	5 CU max
Iron	3	0.3 mg/l max average	0.05 mg/l max average
pH	4	7.0 min average	7.8 - 8.3
Sulfide	4	0.1 mg/l max average	0.02 mg/l max average
TDS	4	500 mg/l max average	400 mg/l max average
Nitrate	4	10.0 mg/L max average	0.4 mg/L max average
Nitrite	4	1.0 mg/l max average	0.05 mg/l max average
Calcium Hardness	4	50 mg/L as CaCO ₃ min average 250 mg/L as CaCO ₃ max average	100 mg/L as CaCO ₃ max average
Hardness	4	300 mg/L as CaCO ₃ min average	150 mg/L as CaCO ₃ min average
Ammonia	4	1.0 mg/L N max average	0.02 mg/L N max average
Chlorine Demand	5	N/A	Add
DBP Formation Potential	5	N/A	Add
Odor (TON)	5	N/A	3
Conductivity	N/A	850 umhos/cm max average	850 umhos/cm max average
Temperature	N/A	35 degrees C max average	35 degrees C max average
Alkalinity	N/A	100 mg/L as CaCO ₃ min average	100 mg/L as CaCO ₃ min average
Turbidity	N/A	1.0 NTU max average	1.0 NTU max average
Fluoride	N/A	0.8 mg/L as F max average	0.8 mg/L as F max average
Ortho P	N/A	1.0 mg/L as P max average	1.0 mg/L as P max average
Sulfate	N/A	250 mg/L max average	250 mg/L max average
Chloride	N/A	250 mg/L max average	250 mg/L max average

1.2 Objectives

The objective of this study was to characterize source water quality, prioritize treatment locations, identify potential treatment approaches, benefits, and the associated costs for treatment to meet the proposed water quality changes, which will begin to inform Tampa Bay Water and the member governments on the implications of changing the Exhibit D requirements and identify next steps to further refine the implications. Each of the parameters listed in Table 1-3 were evaluated during this study;

however, a significant focus of the study was the evaluation of the proposed TOC goal since this goal was the highest priority of the member governments and was expected to drive the need for most of the proposed treatment and associated cost.

1.3 Scope of Work

The overall scope of work for this project includes:

- Evaluation of the desired, prioritized water quality parameters as summarized in Table 1-3.
- Identification and prioritization of source waters that require the highest level of treatment by considering both concentrations and characterization of the source water quality.
- Estimation of the benefits of various reduced TOC levels and the approach to treating TOC that could achieve those benefits.
- Development of planning level capital and operating costs using currently available, conventional treatment technologies for the identified alternative TOC levels as well as other proposed Exhibit D changes as referenced in Table 1-3.

The approach focused on providing Quality Water at each POC by applying either specific treatment as required at the source water or abandoning/replacing existing water sources where practical. This was in lieu of assessing the water quality requirements directly to the source waters.

The major tasks within the scope of work include the following:

Data Evaluation:

- **Data Review and Analysis:** The purpose of this task was to summarize existing relevant data, identify data gaps, and screen source waters for additional testing.
- **Water Quality Characterization and Source Water Prioritization:** The purpose of this task was to characterize the source water quality (TOC and other water quality parameters) of the screened sources to determine the sources that are considered to have the most impact on water quality. This is especially important with TOC since TOC reacts differently to form disinfection byproducts (DBPs) depending on the TOC character and bromide levels.

System Model Development:

- **Blend Scenarios and Estimated Travel Time Development:** The purpose of this task was to determine the potential blend scenarios at each POC, to determine the potential impacts on blending on the source waters. Blending could improve the overall water quality at the POC.
- **TOC Model Development and Target TOC Evaluation:** The purpose of this task was to develop a preliminary TOC model that can be used to develop a relationship and DBP formation and disinfectant decay, which can then be used to determine the target TOC levels. The model was based on the water quality testing and blending scenario developed in the previous tasks. Due to the limited schedule, the developed model was designed to be a

preliminary model and it was assumed that the model would be further refined based on additional testing and analysis collected in the future.

Estimated Treatment Requirements:

- **Treatment Evaluation:** The purpose of this task was to identify the currently available treatment technologies and the planning level capital and operating cost estimates to treat the identified sources water to meet the potential new target water quality parameters.

2. Data Evaluation

2.1 Approach

The purpose of the data evaluation was to accomplish the following three objectives:

- 1) **Compile the necessary data to construct a system-wide water quality model** - A systemwide model was necessary to simultaneously predict the resultant water quality conditions at the POCs while simulating various combinations of treatment at the sources. The data compiled to support this effort included historical water quality data, new sampling to fill gaps in historical data, and new sampling to collect data on factors which impact DBP formation and residual decay. This section describes the data compilation, while the model development and application are described in Section 3.
- 2) **Collect and analyze the data necessary to estimate benefits of operating at reduced TOC** - Bench-testing studies were conducted to simulate the formation of trihalomethanes (THMs) and the bulk decay of chlorine in a distribution system. These studies were conducted with both raw water and with water which had been diluted to simulate treatment. This work generated the data needed to estimate benefits of operating the Regional system at lower TOC concentrations. Haloacetic acids (HAAs) were excluded from the study as these DBPs were not expected to drive treatment needs for the Tampa Bay Water System given the raw water pH and historical data.
- 3) **Identify target TOC levels leveraging the results of objective 2** - The TOC target levels were established by interpreting the results of objective 2 using the system model described in Section 3.

In order to model the Tampa Bay Water system, it was necessary that the concentration of each “priority” Exhibit D parameters be assumed for each source, with the exception of color and odor since these are not conservative parameters that can easily be modeled. Although not included in Exhibit D, water quality parameters such as bromide were of interest since bromide can impact the speciation of Total THMs (TTHMs). Given the size and complexity of the Tampa Bay Water system, efforts were made to complete the data evaluation efficiently and with an appropriate level of detail and accuracy for developing planning-level cost estimates.

Several simplifying assumptions were made to achieve the desired level of detail and are listed below:

1. *Each individual groundwater well has a fixed water quality.*
2. *The treated water output from the RSWTP and from the Desalination Facility were modeled as fixed sources to the system rather than modeling the raw water being processed through the RSWTP and Desal treatment process.*
3. *The treated water output from the RSWTP and Desal has a fixed water quality based on a combination of historical average conditions and new water quality sampling included with this study.*

In order to establish the assumed water quality for each source, the last 10 years of historical water quality data were summarized. Data gaps were then identified for each source and a sampling plan was developed to fill gaps. To reduce the effort required in taking new samples to fill data gaps, a further simplifying assumption was established:

- 4. Wells within the same wellfield, containing similar historical water quality data, drilled to similar depths, with similar constructed age, have the same water quality.*

This fourth simplifying assumption formed the basis of the “Level-1” groups, which reduced the number of wells that were sampled for this study. Determination of Level-1 groups was a subjective process based on comparing certain major water quality parameters including TOC, chloride, sulfate, sulfide, iron, and ammonia. When the criteria of “Assumption 4” were met, those wells were assigned to a “Level-1 group,” and data gaps were filled by pooling and averaging the last five years of data for a given group and parameter. If there were no historical data available within a group, a field sample was required from at least one well from each Level-1 group. The detailed Level-1 well sampling protocol is included in Appendix B.

One group of parameters which is not included in Exhibit D but is of particular interest is trihalomethanes (THMs). THMs are a group of disinfection byproducts that are formed over time through the reaction of chlorine and TOC. The summation of chloroform, bromodichloromethane, dibromochloromethane, and bromoform represent the regulated group of THMs referred to as total THMs (TTHMs). One way to assess the potential for TOC to convert to THMs is to measure the THM formation potential (THMFP), which is a test where a sample is incubated with excess chlorine to drive the formation reaction to completion. By design, THMFP tests typically yield THM results which are significantly higher than in the actual system since the sample is incubated with very high chlorine residual levels. While less representative of THM levels in the distribution system, the results are useful in serving as a basis of relative comparison from source to source. Being a more costly and time-consuming analytical test, THMFP was not run on Level-1 samples as it was further assumed that the number of THMFP samples could be reduced if another simplifying assumption was made:

- 5. Level-1 groups of the same wellfield containing similar TOC (both in concentration and in character), and bromide levels could be grouped and assumed to have the same THMFP.*

This simplifying assumption was based on the knowledge that TOC concentration, TOC character, and concentration of bromide were the main variables within the Tampa Bay Water regional system that influence THMFP. Other parameters which impact formation potential such as pH and temperature have minimal variation across the groundwater sources and were therefore not included in Assumption 5. To capture the data needed to assess Assumption 5, it was decided that each Level-1 sample would also include analysis for bromide, TOC, UV-254 absorbance, and fluorescent-excitation-emission-matrices (FEEM). This is important since depending on the nature of the organic material, the formation of DBPs may vary even though the TOC concentration is the same between two water sources.

FEEM can describe the class of the organic material (i.e. humic-like, fulvic-like microbiological, etc.). An example FEEM result is shown in Figure 2-1.

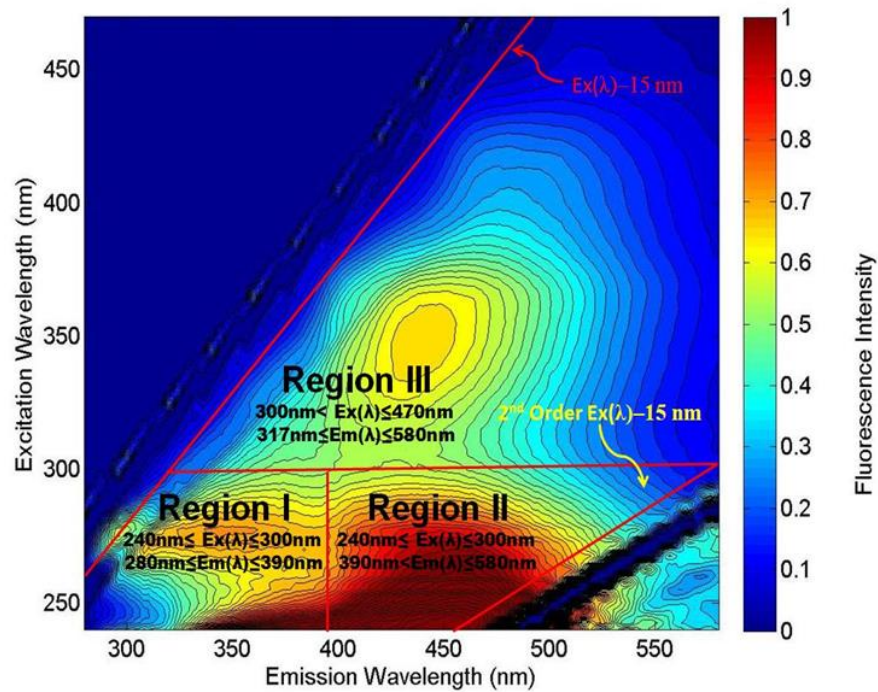

Figure 2-1: Example FEEM showing Region I, II, and III

The peaks observed in Region I, II, III are correlated to the presence and concentration of microbial-like, fulvic acid-like, and humic acid-like organic compounds respectfully. For the purpose of analyzing these results, the peaks were resolved to regional values using the fluorescent regional integration method described by Chen et. al (2003)¹.

UV-254 absorbance is another useful measurement (when compared against TOC concentration) since it describes the overall aromaticity of the organic matter. Both the class and aromaticity are known to impact THMFP. Level-1 results were then analyzed and compared to assign groups which met the criteria of Assumption 5.

When the criteria of Assumption 5 were met, those wells were assigned to a “Level-2 group”, which reduced the number of wells sampled for THMFP. A single well from each Level-2 group was then sampled for THMFP, TOC, and UV-254 absorbance. The THMFP and TOC values were then populated for each well within a Level-2 group. A more detailed protocol describing the Level-2 sampling is included in Appendix C. A graphical representation of the Level-1 and Level-2 grouping process is shown in Figure 2-2.

¹ Chen, W., Westerhoff, P., Leenheer, J. A., & Booksh, K. (2003). Fluorescence Excitation–Emission Matrix Regional Integration to Quantify Spectra for Dissolved Organic Matter. *Environmental Science & Technology*, 37(24), 5701-5710. doi:10.1021/es034354c

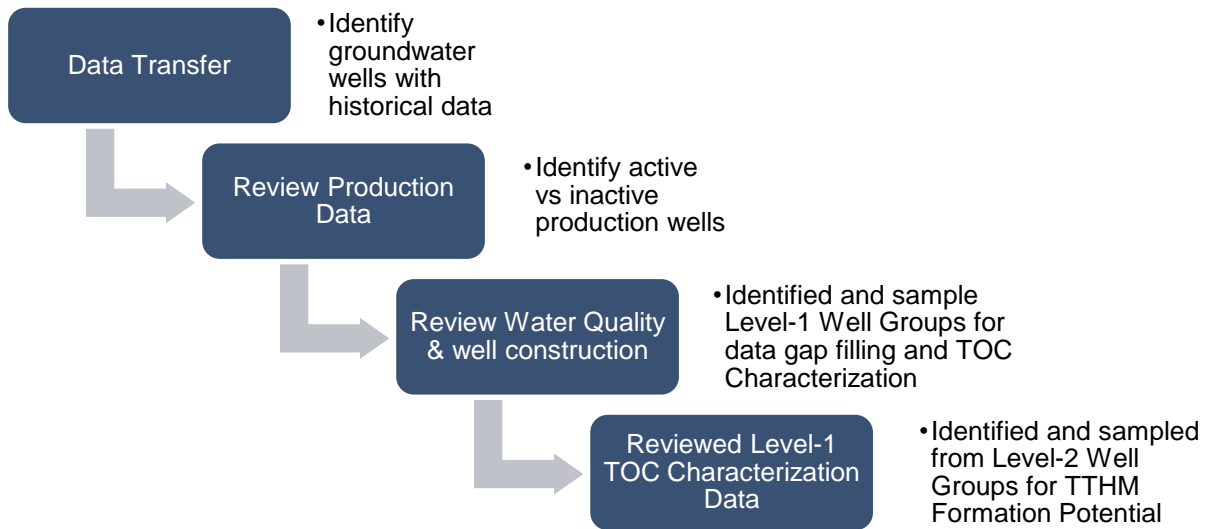

Figure 2-2: Graphic Representation of Well Grouping Process

Upon completion of the Level 2 sampling, water quality assumptions for each potential new Exhibit D parameter and THMFP could be modeled throughout the entire system. Water quality assumptions for each well were selected using the basis illustrated in Figure 2-3.

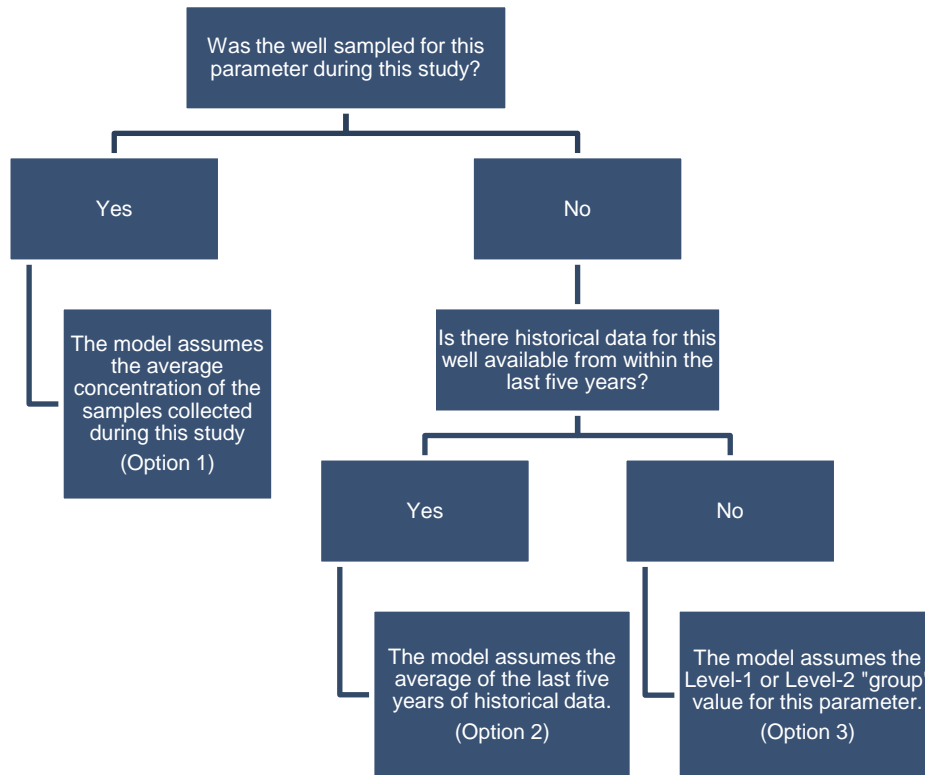

Figure 2-3: Basis for determining the modeled water quality for each source

Table 2-1 is an example of the percentage of wells, for two water quality parameters, that fell into each data group described in Figure 2-3.

Table 2-1: Example Breakdown Showing Percentage of Wells Using Option 1, 2, or 3 for Modeled Water Quality

	TDS	Bromide
Option 1	70%	80%
Option 2	1%	11%
Option 3	29%	9%

In order to relate THMFP to more reasonable THM levels that may simulate the level of formation within a distribution system, a different THM formation test was required, namely simulated distribution system (SDS) testing. A subset of locations was selected for SDS testing and chlorine/chloramine decay testing. The basis and assumptions used to identify this subset were based on the results of the Level-2 testing and is described in Section 2.2. The protocol for this testing is contained in Appendix D. These locations were referred to as “Level-3” locations and were selected to establish a relationship between TOC, residual decay, and THMs, at sites likely requiring treatment to meet potential new standards. To determine how much the impact the TOC concentration had on decay and THMs, the TOC at these sites were tested under both undiluted and diluted conditions. Dilution with deionized water was used to simulate treatment at various levels. Including the raw sample, three levels of dilution were tested per site leading to 15 samples tested during Level-3 testing. These data could then be used along with system-wide knowledge to extrapolate how treatment at any source throughout the system may impact the water quality conditions at the POCs.

TOC target levels were established by comparing the predicted benefits associated with THM formation and residual decay to the TOC levels to determine what TOC concentration(s) would be appropriate for further analysis within this report. This process was subjective and is described in Section 2.2.

2.2 Data Summary

2.2.1 Existing Data

Water quality data from October 2008 until October 2018 were reviewed for 180 groundwater wells, RSWTP finished water, and Desalination WTP finished water. Of the 180 groundwater wells, 23 wells were excluded from the system model: 15 were classified as abandoned and 8 were indefinitely offline. This left 157 wells, which were grouped into Level-1 groups. Table 2-2 shows the number of groundwater wells included at each sampling effort and the level of analytical effort associated with each level. A list of well grouping designations is provided in Appendix F.

Table 2-2: Sampling Analysis

	Number of Samples	Analytical Work	Level of Analytical Effort
Historical Data	180 (157 active)	N/A	No analytical work
Level-1 Group Samples	106	Exhibit D parameter gaps, bromide, TOC, UV-254, FEEM	Standard analytical work
Level-2 Group Samples	67	TOC, UV-254, THMFP	Basic laboratory study
Level-3 Locations	5 (15 when counting dilutions)	TOC, UV-254, SDS	Advanced laboratory study

2.2.2 Level-1 Grouping

Level-1 groups were selected by analyzing the past five years of historical water quality focusing on Exhibit D parameters. Groundwater wells located in the same wellfield with similar construction age and depth were then identified before reviewing concentration results for the Exhibit D parameters. Groups were formed subjectively, but conservatively, based on water quality. All the groundwater wells in each respective group, no matter how large or small the group, had similar water quality to the rest of the group.

For example, Figure 2-4 shows the historical TOC concentrations of a potential grouping in the Cross Bar Wellfield and also shows the historical chloride concentrations of the potential grouping. The TOC and chloride results suggest similar water quality within these wells, which can potentially be grouped together. However, all water quality parameters needed to be examined before grouping the wells to have the greatest confidence with similar water quality in each group. Figure 2-5 shows the historical iron concentrations for this potential grouping. The iron concentrations within well CB1 have been historically higher than the other wells within that grouping. In this scenario, assuming all other parameters are similar, CB1 was placed into its own group or potentially grouped with other wells.

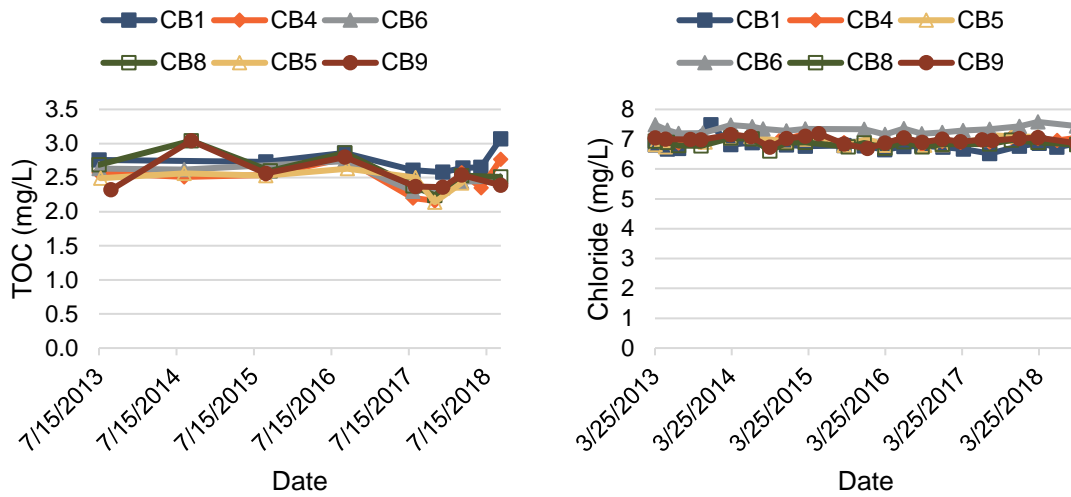

Figure 2-4: Well Grouping Analysis Total Organic Carbon (mg/L) & Chloride (mg/L)

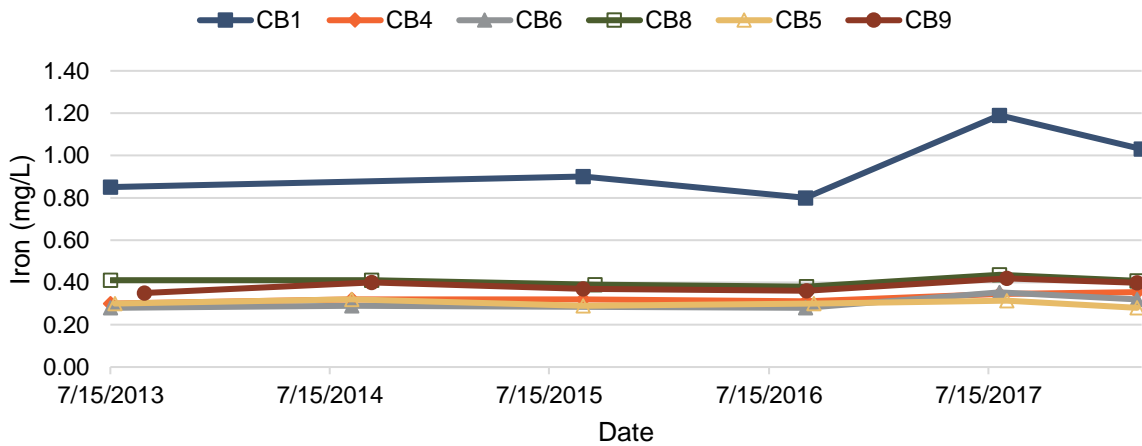

Figure 2-5: Well Grouping Analysis Iron (mg/L)

From the initial analysis it was determined that in order to accurately group wells for the Level-2 sampling, gaps in data would need to be filled as part of the Level-1 sampling effort. Thus, along with fluorescence and TOC, bromide and total dissolved solids (TDS) analyses were run for each of the 106 groups. The data gathered from the Level-1 sampling effort showed a relatively wide distribution of results across FEEM, UV-254, and TOC. The TOC results are shown in Figure 2-6. Specific UV-254 absorbance (SUVA) was also calculated for each sample. Additional water quality sample results are provided in Appendix J.

Tampa Bay Water
 Evaluation of Exhibit D Water Quality
 Final Report

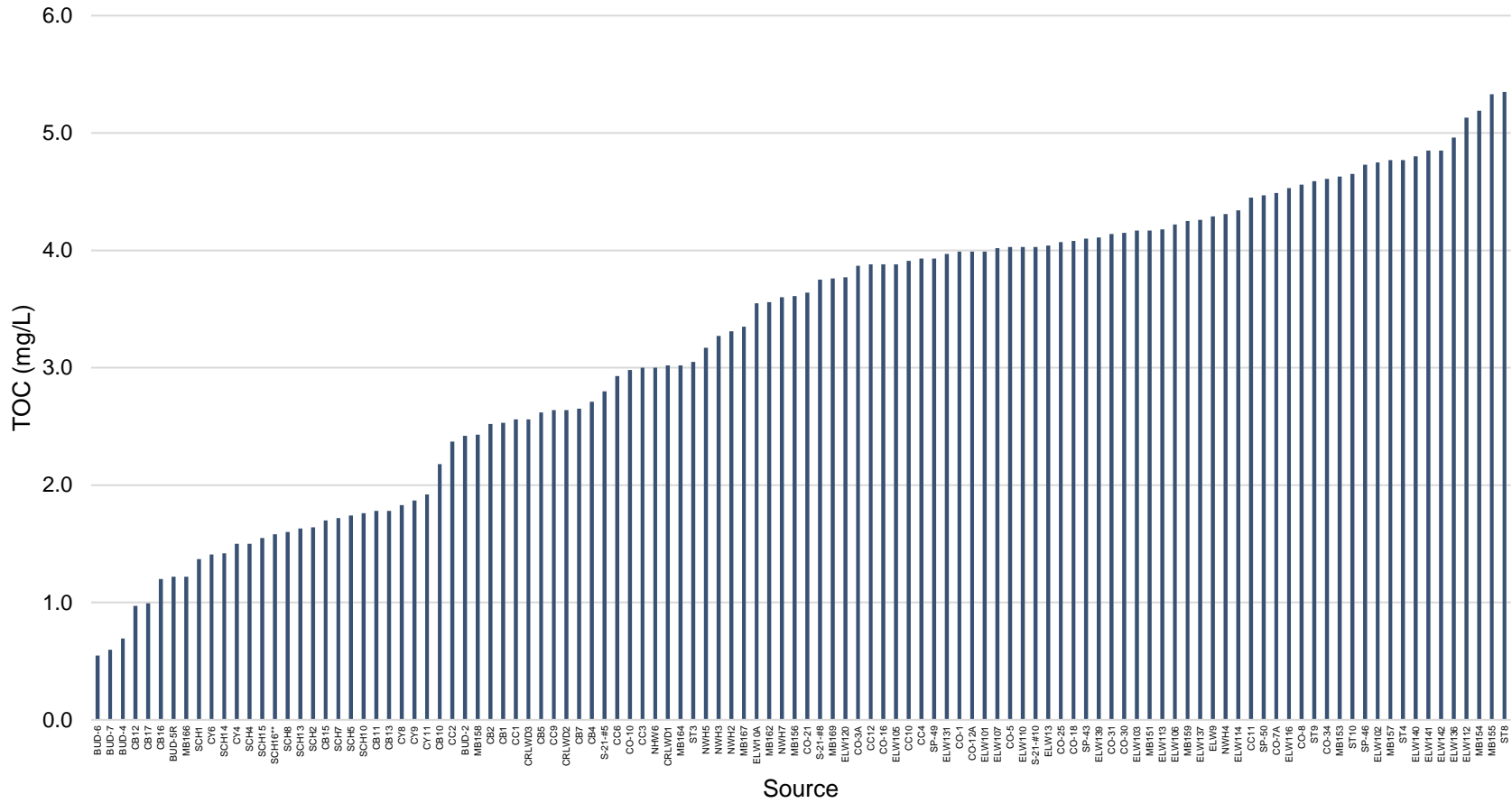

Figure 2-6: Level-1 TOC results

2.2.3 Level-2 Grouping

By combining select Level-1 groups together, 67 Level-2 groups were formed. An example comparison of two Level-1 results are shown in Table 2-3 and Figure 2-7.

Table 2-3: Level-2 Grouping Comparison for ELW103 and ELW116 Level-1 results

Sample	TOC (mg/L)	Region I Fluorescence (au)	Region II Fluorescence (au)	Region III Fluorescence (au)	Bromide (mg/L)	SUVA (L/mg-m)
ELW103	4.2	2431	12908	15674	0.043	2.46
ELW116	4.5	2347	16168	19750	0.103	3.26

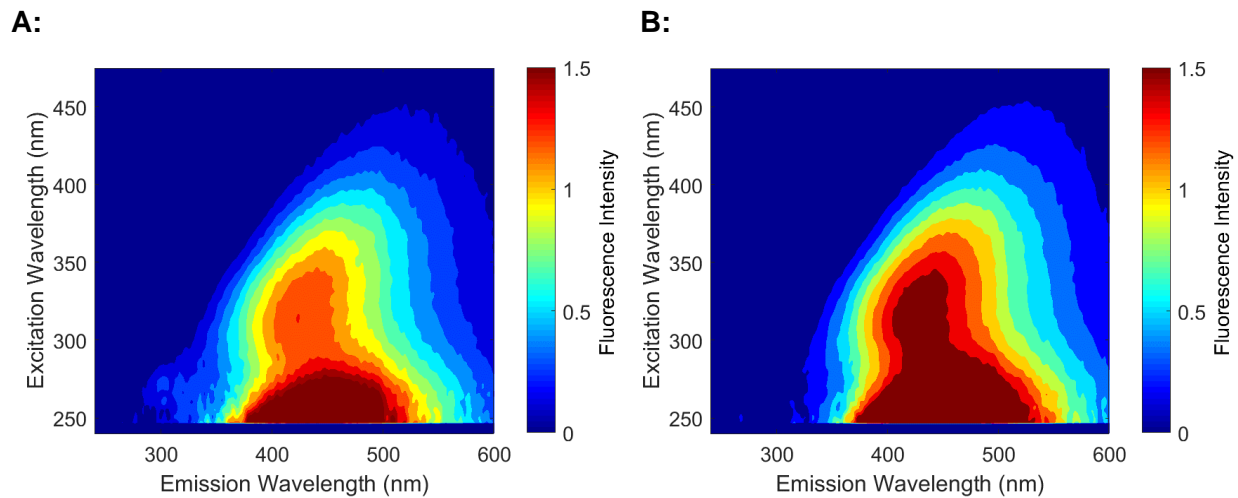

Figure 2-7: Comparison on FEEM for (A) ELW103 and (B) ELW116

In this example, significant differences in fluorescence, bromide, and SUVA are apparent as shown in Table 2-3. Comparison of the FEEMs show a distinctive peak in Region I for ELW103, which is not present in ELW116. This difference is reflected in a higher overall Region I fluorescence shown in Table 2-3. Conversely, Region II and III fluorescence was higher in ELW116 along with higher overall aromaticity as measured by SUVA. As a result, these Level-1 samples were not merged into a single Level-2 group.

After regrouping, at least one well from each of the 67 Level-2 groups was then sampled for THMFP, TOC, and UV-254 absorbance. The results of this testing showed a strong linear correlation between TOC and THMFP as shown in Figure 2-8.

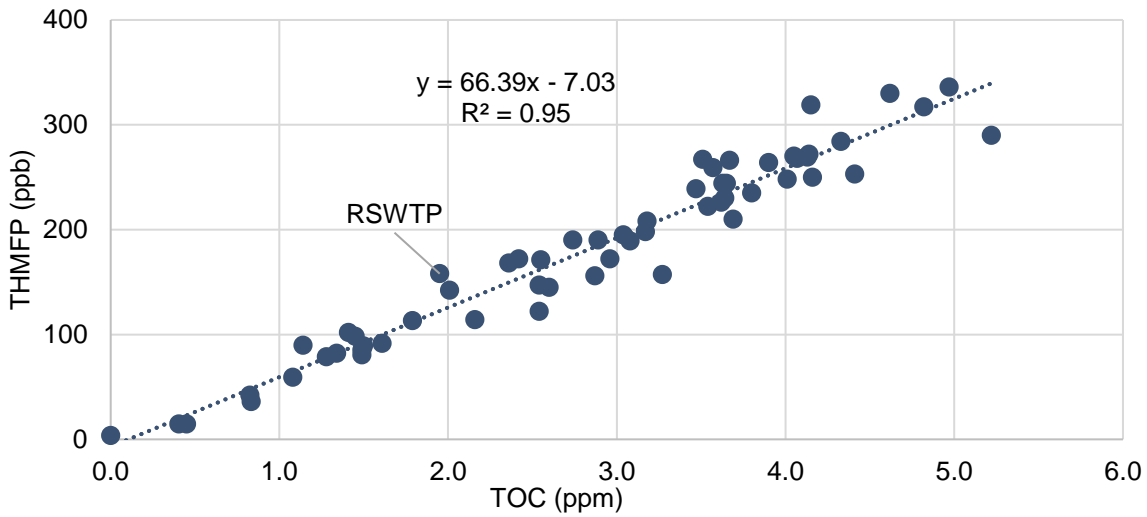

Figure 2-8: Level-2 Results Showing Strong Linear Correlation Between TOC and THMF

This correlation also appeared to adequately describe the single sample collected from the RSWTP as identified in Figure 2-8. However, the correlation of the data appeared stronger for samples with TOC less than 2.0 mg/L. This variation was further assessed by calculating the specific THMF, which is the THMF divided by the paired TOC. The specific THMF results are shown in Figure 2-9, which shows that the RSWTP had the highest specific THMF.

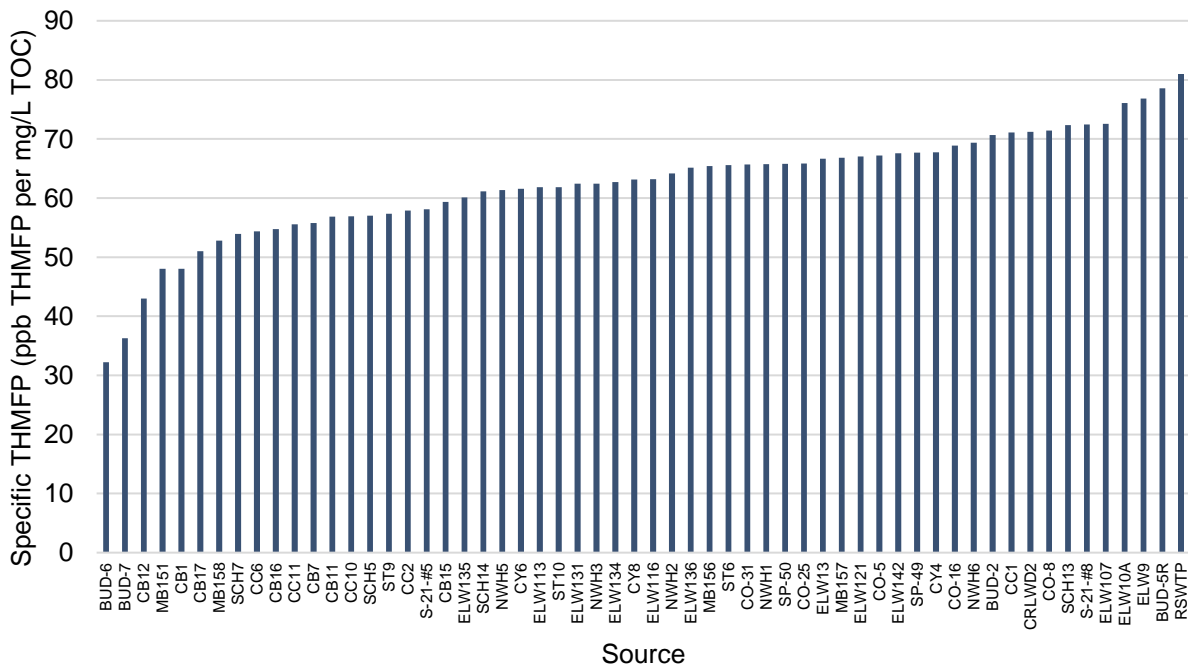

Figure 2-9: Level-2 Specific THMF (ppb THMF per mg/L TOC)

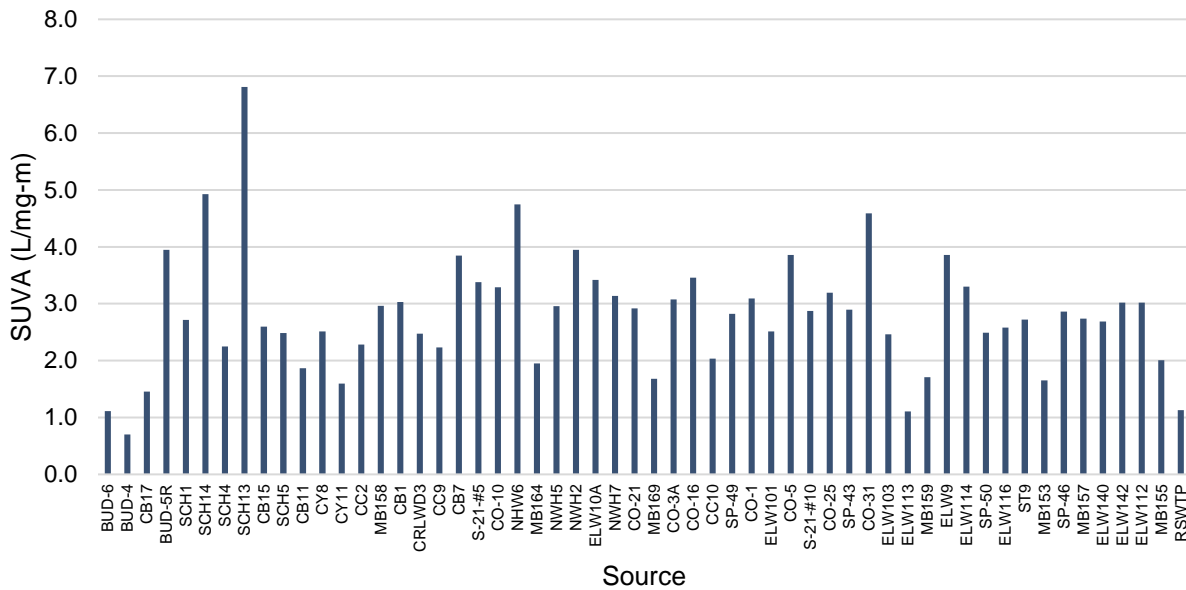

Figure 2-10: Level-2 Specific UV-254 Absorbance (L/mg-m)

Two conclusions can be drawn from the specific THMFP and SUVA results:

- **There is variability in the THMFP which is independent of TOC:** This is explained in the range of specific THMFP potential, which goes from approximately 30 to 80 ppb THMFP per mg/L TOC. The regional surface water treatment plant has the highest specific THMFP, which is expected since the surface water TOC typically has a significantly different nature compared to the groundwater sources.
- **A 1 mg/L goal for TOC at each POC would likely be excessively conservative:** The specific THMFP suggests that for 1 mg/L of TOC, only the most reactive samples would likely exceed the maximum contaminant limit (MCL) of 80 ppb under exaggerated conditions with excess free chlorine and reaction time.

The results shown in Figure 2-8 and Figure 2-9 suggested that a further simplifying assumption could be made:

6. *There is a sufficiently linear correlation between THMFP and TOC to assume that TTHM levels can be predicted from TOC alone, ignoring variations explained by TOC nature and bromide for the initial planning level cost estimation.*

It is important to emphasize that simplifying “Assumption 6” is justified for purposes of this study and developing a planning level cost estimate, but it is not recommended that this assumption be carried forward into future detailed iterations of cost estimation, design, or simulation of the regional system. Variations in TOC characteristics by source do exist and were observed through SUVA and FEEM analysis. Therefore, a refined model that captures these variations would help further refine the estimated treatment requirements and costs.

2.2.4 Level-3 Test Locations

Five locations were selected for Level-3 testing. These locations represented “sources” as depicted in Figure 1-2 and included Eldridge Wilde Wellfield (ELW), Morris Bridge Wellfield (MB), South Pasco Wellfield (SP), Starkey Wellfield (MAY), and Cosme-Odesa Wellfield (CO). These sites were selected based on a preliminary indication that treatment would be necessary at these locations to meet the proposed water quality goals. This preliminary indication was the result of using the system model (described further in Section 3) assuming a goal of 1 mg/L TOC at each POC. The selected sources had significant influence on POC water quality and had TOC levels that exceeded 1 mg/L. To simulate treatment, samples from these sites were diluted with deionized water and tested following the SDS protocol described in Appendix D. By running SDS tests on diluted samples, data could be generated representing a wide range of TOC which facilitated assessment of potential benefits of operating the Tampa Bay Water system at lower TOC concentrations.

Figure 2-11 shows the results of the free chlorine residual decay observed during the SDS tests.

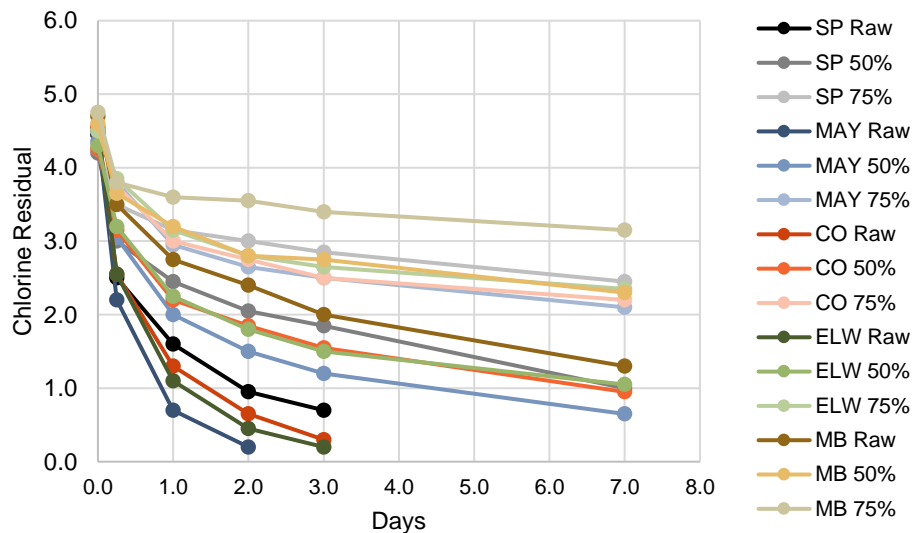

*Legend represents % removal through dilution

Figure 2-11: Level-3 Testing Free Chlorine Decay Curves

Key observations include:

- Samples with higher TOC decayed more rapidly and lost residual after 2-3 days.
- Samples with lower TOC maintained residual above 2.0 mg/L to the beyond the 7th day.
- In practice, chlorine residuals would typically target a lower residual after 7 days of incubation. This would suggest that THM data presented from these SDS tests are conservative.

Figure 2-12 shows the total chlorine residual decay results from the chloramine SDS testing, which indicated that the chloramine residual was overall more stable with regards to bulk decay compared to free chlorine residual. Each sample persisted to the seventh day, but the residuals increased as the TOC decreased.

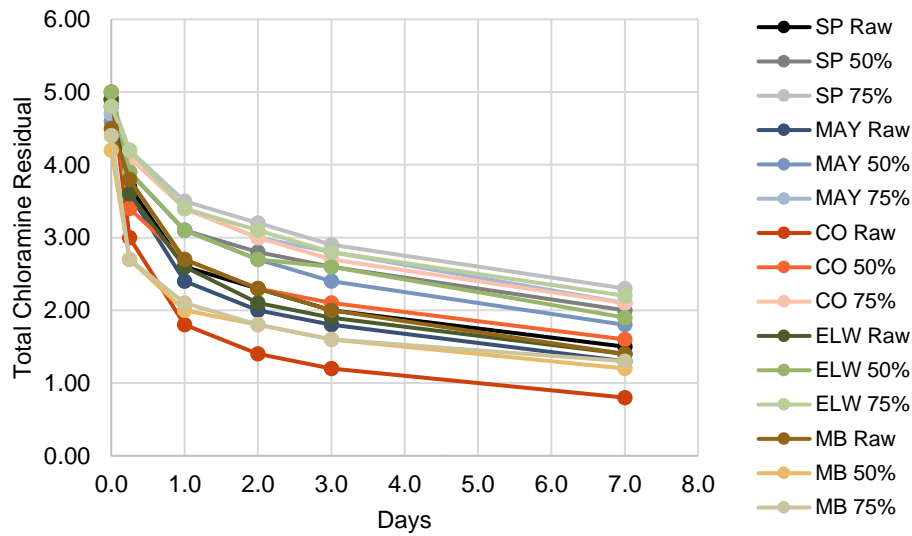

*Legend represents % removal through dilution

Figure 2-12: Level-3 Testing Chloramine Decay Curves

Figure 2-13 shows the TTHM results from the free chlorine SDS testing. As expected, samples with higher TOC had more rapid TTHM formation.

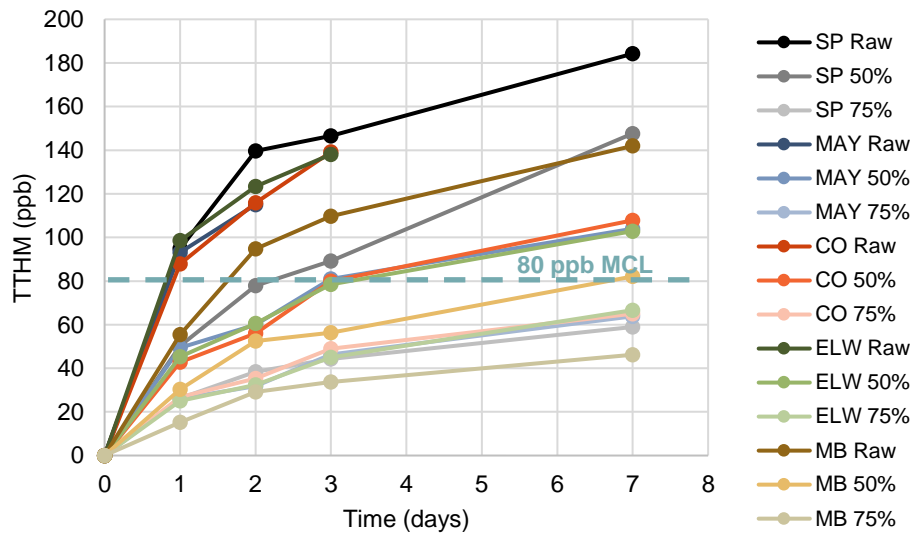

*Legend represents % removal through dilution

Figure 2-13: Level-3 Testing Free Chlorine SDS Curves

Figure 2-14 shows the TTHM results from the chloramine SDS testing. As expected, samples with higher TOC had more rapid TTHM formation; however, as also expected, in comparison to the free chlorine testing, the TTHM formation was significantly less. Along with providing a more stable residual, this was one of the reasons that Tampa Bay Water initially converted to chloramines.

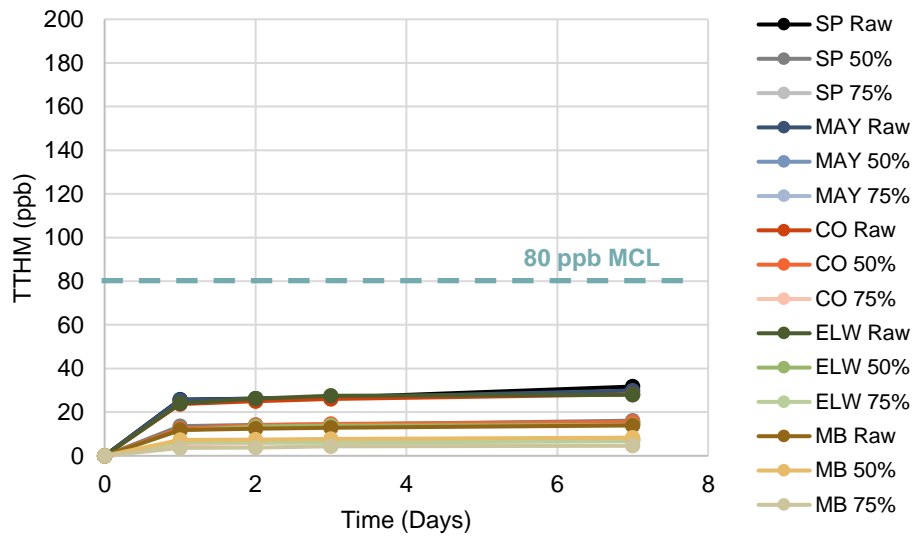

*Legend represents % removal through dilution

Figure 2-14: Level-3 Testing Chloramine SDS Curves

2.3 Data Analysis

To determine the TOC target based on a free chlorine residual, a relationship between TOC and SDS TTHM values was established. This was accomplished by correlating the SDS TTHM values for a given incubation time back to the initial sample TOC. This analysis resulted in three strong linear correlations shown in Figure 2-15. These linear regressions appeared to follow a trend such that a 5-day SDS regression could be estimated and leveraged when estimating TOC targets.

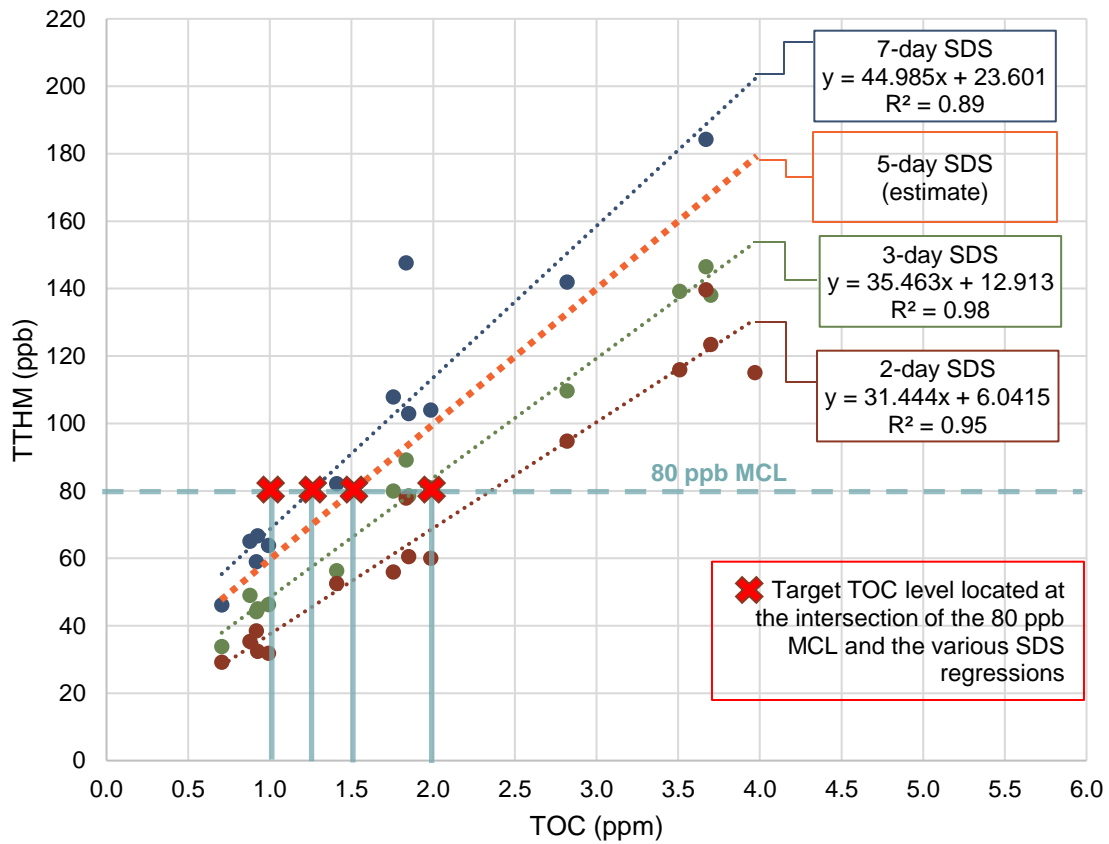

Figure 2-15: Relationship between Level-3 TOC, Incubation Time, and SDS TTHM based on free chlorine residual

From Figure 2-15, four TOC targets were identified based on the following criteria shown in Table 2-4.

Table 2-4: Identified Annual Average TOC Targets

TOC Target (mg/L)	Basis for Target ⁽¹⁾	
	Approx. TTHM Concentration	Approx. Residence Time in Distribution System
2.00	< 80 ppb	< 3 days
1.50	< 80 ppb	3 to 5 days
1.25	< 80 ppb	5 to 7 days
1.00 ⁽³⁾	< 80 ppb	> 7 days

1. Predicted TTHM concentration for a given incubation time based on analyzed SDS data using free chlorine residual.
2. TTHM or Total Trihalomethanes is a class of disinfection byproducts (DBPs)
3. Member government requested max average proposed goal.

The timeline for these targets was based on capturing a range of estimated average residence times within the member government’s distribution system and the assumption that the maximum time to each POC from Tampa Bay Water’s source is less than 1.5 days. These targets are based on maintaining the

maximum annual average of TOC at each POC no greater than these levels. The actual residence time within the member government systems and impact on DBP formation will need to be confirmed in future studies.

3. System Model Development

A system model was developed to further evaluate the target TOC conditions, which was necessary due to the complexity of the Tampa Bay Water system. For example, although the water quality from individual wells were assumed to be constant, the blended water quality of the source (i.e. wellfield) is dependent on the specific wells which are operating, each of which can have a wide variety of water quality. Further, the water quality at the POCs are dependent on the blending between sources which supply a given POC. This concept is described graphically in Figure 1-2.

In order to estimate the source water quality and the downstream POC water quality under different conditions, a blending model spreadsheet was developed. The model was used to determine to what extent additional treatment was needed at each source to simultaneously meet the proposed water quality goals at each POC. Given that several sources feed several POCs simultaneously, this presented a complex optimization question, which required a model to efficiently identify the most effective treatment locations.

3.1 Selected Water Quality Parameters

The four POC annual average TOC targets discussed in Section 2.3 were utilized in the water blending model to determine the water quality treatment requirements for the various source waters that supply the POCs. During the modeling effort, some water quality parameters were found to not require additional treatment (e.g. TDS) at any source in order to simultaneously meet the revised criteria at each POC. As a result, some of the water quality parameters were excluded from further analysis and the remaining parameters have been summarized in Table 3-1.

Table 3-1: Selected Exhibit D Parameters for Further Study

Parameter	Existing Limit	Proposed Goal
TOC	4.6 mg/l max average 6.5 mg/l max	1.0 mg/L max average 2.0 mg/L max
Iron	0.3 mg/l max average	0.05 mg/l max average
pH	7.0 min average	7.8 - 8.3
Sulfide	0.1 mg/l max average	0.02 mg/l max average
Nitrate	10.0 mg/L	0.4 mg/L
Nitrite	1.0 mg/l	0.05 mg/l max average
Calcium Hardness	250 mg/L as CaCO ₃	100 mg/L as CaCO ₃ max average

3.2 Source Water Quality Variability

The historical water quality data compiled per the approach described in Section 2, provided representative water quality values for 22 parameters at each of Tampa Bay Water’s 157 active supply wells, the Desalination Facility, and Surface Water Treatment Plant. These assumed concentrations are provided in Appendix G. Water quality from each of the wellfields vary depending on which wells are in operation, and how much total flow is being supplied. When depicting average conditions, the source water quality assumed by the model was equivalent to the average water quality of all wells within a wellfield considering the flow contribution from each well. When depicting the “maximum” concentrations, the model assumed water quality equivalent to the well providing the “worst” water quality for a given parameter. The model also takes into account changes in water quality due to existing treatment (e.g. chloramination, hydrogen sulfide removal, and pH adjustment). Graphs of water quality variation are included in Appendix E.

3.3 POC Water Quality Variability

Water quality variability at the source can translate into water quality variability at the Points of Connection (POCs). Some POCs are supplied from a combination of regional sources, and others are supplied by a dedicated source. This study evaluated the additional treatment that would be needed to meet the proposed water quality goals at all POCs.

The spreadsheet simulation model was used to determine what treatment would be needed at each source to achieve the proposed water quality at the POCs. The tool also calculates the variability in concentrations that could occur at each POC based on the best and worst case blends from the regional system RPOEs. This variability is calculated as a flow weighted average of sources from the RPOEs as the supply travels through the system, combining additional RPOEs and delivering supply to POCs.

Table 3-2 lists the flow assumptions that were used for this evaluation, and the estimated percentage of each source that reaches each POC based on historical data. These flows can vary, depending on what supply sources are prioritized by Tampa Bay Water’s Optimized Rotational Operation Program, and seasonal fluctuations in demands. It is important to note that the flow assumptions used in this model were not based on design maximum or sustainable maximum flows from each source, but rather from typical historical average usage. As demands in the system increase, the actual blend of sources utilized will likely change and potential impacts on the model will need to be re-assessed based on the water quality of the increased sources. Using the source water quality and blending described in Table 3-2, maximum, minimum and average concentration could be estimated for each POC.

Table 3-2: Source and Delivery Flow Assumptions and Estimated Percentage of Source at POC for Average Conditions

Point of Connection	Source (%)																	
		Desal	RSWTP	SCH	BUD-5	BUD-7	MB	CY	CB	CC	SP	S-21	NWH	CO	ELW	ST	TOTAL	
	Average Flow (mgd)	8.1	64.1	20.0	3.0	1.5	10.0	8.0	10.0	10.0	8.0	4.0	4.0	10.0	11.0	5.0	176.7	
Lithia Regional (Hillsborough)	8	5	39	0	38	19	0	0	0	0	0	0	0	0	0	0	0	100
Lithia SCH Wellfield (Hillsborough)	20	0	0	100	0	0	0	0	0	0	0	0	0	0	0	0	0	100
Central Hillsborough (Hillsborough)	11	11	89	0	0	0	0	0	0	0	0	0	0	0	0	0	0	100
Morris Bridge (Tampa)	0.1	10	76	0	0	0	15	0	0	0	0	0	0	0	0	0	0	100
Lake Bridge (Pasco)	8	10	76	0	0	0	15	0	0	0	0	0	0	0	0	0	0	100
US41 (Pasco)	11	7	51	0	0	0	10	9	11	11	0	0	0	0	0	0	0	100
Lake Park Regional (Hillsborough)	4	3	27	0	0	0	5	5	6	6	47	0	0	0	0	0	0	100
Lake Park S21 Wellfield (Hillsborough)	4	0	0	0	0	0	0	0	0	0	0	100	0	0	0	0	0	100
NWH Regional (Hillsborough)	5	3	27	0	0	0	5	5	6	6	47	0	0	0	0	0	0	100
NWH Wellfield (Hillsborough)	4	0	0	0	0	0	0	0	0	0	0	0	100	0	0	0	0	100
Cosme POC (St. Petersburg)	30	4	28	0	0	0	5	5	6	6	13	0	0	33	0	0	0	100
Cosme Bypass (St. Petersburg)	0.1	7	51	0	0	0	10	9	11	11	0	0	0	0	0	0	0	100
Odessa (Pasco)	6	7	51	0	0	0	10	9	11	11	0	0	0	0	0	0	0	100
Maytum (New Port Richey)	3.5	0	0	0	0	0	0	0	0	0	0	0	0	0	0	0	100	100
Little Road Regional (Pasco)	9	5	43	0	0	0	8	8	10	10	0	0	0	0	0	0	17	100
Keller Regional (Pinellas)	42	7	51	0	0	0	10	9	11	11	0	0	0	0	0	0	0	100
Keller H2S Eldridge Wilde Wellfield (Pinellas)	11	0	0	0	0	0	0	0	0	0	0	0	0	0	0	100	0	100

To simulate the application of a new treatment technology at a given source, the treatment percent removal (or percent increase for pH) at each source was adjusted within the model and the resulting changes in delivery water quality for that parameter was predicted at each of the POCs. To predict how much of a parameter needs to be removed from the source, these treatment percentages were adjusted to achieve the potential new target water quality goal at each POC. Where practical, no treatment was also applied at certain sources to take advantage of blending with other lower concentration sources before reaching a delivery POC. Other sources where treatment would be required, the treatment percentage could be increased to reduce the total number of sources that require treatment. POCs with dedicated sources required treatment to meet the water quality goals since blending is not available. Note, existing treatment (e.g. chloramination, hydrogen sulfide removal, and pH adjustment) were applied at the source within the model to account for existing treatment that already addressed some of the water quality goals.

The overall intent of the modeling effort was to optimize placement of treatment technologies in the system to achieve the desired water quality goals at all POCs in a cost-effective manner, as well as to understand where the highest return on investment relative to cost versus water quality improvement exists. The tool can also be used for assessing the prioritization and phasing of water quality improvement projects.

The model also includes the ability to simulate the application of treatment technologies at individual wells or to remove wells from service in the future. Table 3-3 lists the wells that are still currently operating but were removed from service for future scenarios based on future wellfield right-sizing efforts.

Table 3-3: Wells Removed in Future Scenarios

Wellfield	Wells
Morris Bridge	152, 157, 161, 162, 163
Starkey Wellfield	9
Eldridge Wilde Wellfield	13, 114, 134, 139

4. Predicted Treatment Requirements

The water blending spreadsheet model described in Section 3 was used to determine the locations and percent removals that would be required at the RPOEs to the regional system to meet the water quality goals at each POC. It was assumed that treatment would be applied to sources rather than the POC. Treating at the source allowed for treatment selection that was tailored for the water quality conditions unique to each source. For example, if a POC was fed from three sources, but only one source had sulfide, then sulfide treatment could be applied to that specific source rather than sizing sulfide treatment for the entire flow at the POC, which would increase the overall cost. This source-treatment approach allowed for increased flexibility in process selection, while ultimately focusing on the water quality at the POC which was often a blend of multiple sources.

Given that four TOC targets were developed, Table 4-1 presents the four scenarios combining TOC treatment targets with the other water quality goals. Several treatment technologies were evaluated, and an appropriate technology was identified based on the required treatment and percent removals of the various water quality parameters.

Table 4-1: Identified Treatment Scenarios

Scenario A	Scenario B	Scenario C	Scenario D
TOC – 2.0 mg/L max average	1.5 mg/L TOC max average	1.25 mg/L TOC max average	1.0 mg/L TOC max average 2.0 mg/L TOC max
Common Treatment Goals Among Scenarios			
Iron – 0.05 mg/L max	Nitrate – 0.4 mg/L max average	Calcium – 100 mg/L as CaCO ₃ max avg	pH – 7.8 – 8.3 max
Sulfide – 0.02 mg/L max	Nitrite – 0.05 mg/L max average		

4.1 Location and Estimated Percent Removal

The system model was optimized using SOLVER (Excel based product) to simultaneously determine which sources required treatment and the extent of treatment required. SOLVER checked hundreds of iterations of treatment to obtain a solution based on achieving TOC no higher than the target concentration using the minimum amount of treatment at the fewest number of locations. The output from solver was then manually adjusted by the project team based on knowledge of the site or other limitations to further optimize the distribution of the required treatment.

Table 4-2 summarizes the results of this analysis with respect to the four target TOC levels based on maximum averages at each POC. These results were optimized to have treatment at the fewest locations, while maintaining similar water quality across the regional system. The results have some flexibility; for example, higher percent removal at the Surface Water Treatment Facility would allow lower percent removal at other downstream locations such as Morris Bridge, Cypress Creek, or Cross Bar Ranch Wellfields; however, there could be increased variability of TOC at the POCs. Graphs of TOC at the sources and POCs are provided in Appendix E.

Table 4-2: Location and TOC Percent Removal Requirements

Source	Initial TOC (mg/L)	Annual Average Production (MGD)	Calculated TOC Percent Removals			
			Scenario A (2.0 mg/L TOC)	Scenario B (1.5 mg/L TOC)	Scenario C (1.25 mg/L TOC)	Scenario D (1.0 mg/L TOC)
Desalination	0.4	8.1	0%	0%	0%	0%
Surface Water	2.0	64.1	0%	45%	50%	50%
South-Central Hillsborough Wellfield	1.6	20.0	0%	5%	25%	40%
Brandon 5	1.2	3.0	0%	0%	0%	0%
Brandon 7	0.5	1.5	0%	0%	0%	0%
Morris Bridge Wellfield	3.7	10.0	45%	50%	80%	85%
Cypress Bridge Wellfield	1.7	8.0	0%	0%	0%	0%
Cross Bar Ranch Wellfield	2.1	10	0%	0%	0%	55%
Cypress Creek Wellfield	3.1	10.0	0%	0%	25%	55%
South Pasco Wellfield	4.3	8.0	55%	70%	75%	80%
Section 21 Wellfield	3.6	4.0	45%	60%	65%	75%
Northwest Hillsborough Wellfield	3.3	4.0	40%	55%	65%	70%
Tampa-Hillsborough Interconnect	2.6	1.0	25%	45%	55%	65%
Cosme-Odessa Wellfield	4.1	10.0	55%	65%	70%	80%
Eldridge Wilde Wellfield	4.0	11.0	55%	65%	75%	80%
Starkey Wellfield	4.6	5.0	60%	70%	75%	80%

Each source was then assessed for the required treatment to achieve the proposed target average water quality at the POCs for parameters other than TOC. Appendix E includes the detailed percent removal at each RPOE site, the model output for the RPOE and POC concentrations for existing treatment, and the potential treatment necessary to meet the potential Exhibit D revisions.

Calcium hardness was “priority 4” parameter under the proposed water quality goals as identified in the potential Exhibit D changes. Due to the significant costs associated with calcium hardness removal, this parameter was investigated separately. Calcium hardness reduction percentage predictions varied by source, with most equating to approximately 50 percent. A summary of the estimated calcium hardness treatment requirements at each source is presented in Table 4-3.

Table 4-3: Estimated Calcium Hardness Removal Requirements

Site Name	Flow (MGD)	Percent Removal (%)
Surface Water Treatment Plant	64	55
Cross Bar Wellfield	10	50
BUD5	3	60
Northwest Hillsborough Wellfield	4	45
South-Central Wellfield	20	30
Morris Bridge Wellfield	10	60
Cypress Creek Wellfield	10	50
South Pasco Wellfield	8	50
Section 21 Wellfield	4	50
Cosme-Odessa Wellfield	10	50
Eldridge Wilde Wellfield	11	50
Starkey Wellfield	5	50
Total	159	N/A

4.2 Potential Treatment Processes

Table 4-4 presents the potential treatment technologies and estimated performance assumptions for treatment of TOC and the other water quality parameters identified in Table 4-1 based on typical industry standards. These assumptions will need to be confirmed in future studies. Depending on the extent of treatment required and combination of parameters, different treatment trains were selected.

Table 4-4: Proposed Treatment Technologies and Performance Assumptions

Treatment Process	TOC Removal	Anion Removal	Sulfide Removal	Iron Removal	Calcium Hardness Removal	Additional Considerations	Residual Streams
GAC	80-90%	N/A	N/A	N/A	N/A	Constituents of emerging concern (CEC) removal, taste and odor improvement	Backwash
Ozone-Biofiltration	20-30%	N/A	N/A	N/A	N/A	CEC removal, reduced O&M	Backwash
Magnetic Ion Exchange (MIEX)	75%	90%	N/A	N/A	N/A	Potentially compliments coagulation (removes low molecular weight TOC)	Brine
Anion Exchange	75%	90%	N/A	N/A	N/A	Resin selection can provide efficient removal of target constituents	Brine
Cation Exchange	N/A	N/A	N/A	N/A	90%	Lower O&M compared to lime softening	Brine
Greensand	N/A	N/A	90% (low levels)	95%	N/A	Can also provide removal of arsenic sulfide	Backwash
Ozone	N/A	N/A	95%	95%	N/A	CEC destruction, taste and odor improvement	N/A

Generally, the treatment process selection was based on the following:

- GAC was selected when the TOC levels were high or if the only treatment required was TOC removal.
- When other anions required treatment such as nitrate, ion exchange was selected. If ion exchange could treat both anions and TOC, then ion exchange also replaced GAC.
- Several options for sulfide treatment were considered.
 - If levels were below 0.6 mg/L, oxidation with chlorine followed by filtration was possible. This process could take advantage of existing chlorination systems. Filtration could sometimes be assumed from another proposed treatment process such as GAC.
 - If iron removal was also desired, greensand or a dual media filter independent of GAC was included.
 - If sulfide levels exceeded 0.6 mg/L, then ozone was assumed for sulfide removal. Because ozone also enhances the feasibility of biofiltration, ozone-BAC (biological activated carbon) was considered for systems also requiring ozone for another purpose.

Using this logic and considering practical factors such as existing site conditions, Table 4-5 summarizes the potential treatment technologies at each source to meet the pertinent water quality goals identified in Table 4-1. These technologies will need to be confirmed in future studies. Additionally, the feasibility of each site to manage the waste stream flows of the selected technology will need to be confirmed in future work. If necessary and feasible, conditions at select sources may drive treatment selection of processes which are not listed in Table 4-4 and may generate less waste. Additional opportunities to either recycle, treat or reduce the waste volumes will also be evaluated. However, at this planning-level stage, consideration of this factor was intentionally limited.

Table 4-5: Summary of Selected Treatment Technologies

Site Name	Treatment Parameters (Excluding Hardness)						Calcium Hardness Only
	TOC	Iron	pH	Sulfide	Nitrate	Nitrite	
Surface Water Treatment Plant	GAC	N/A	Caustic	N/A	N/A	N/A	Cation Exchange
Cross Bar Wellfield	GAC	Greensand	Caustic	N/A	N/A	N/A	Cation Exchange
BUD5	N/A	N/A	Caustic	N/A	Anion Exchange	N/A	Cation Exchange
BUD7	N/A	N/A	N/A	N/A	Anion Exchange	N/A	N/A
Northwest Hillsborough Wellfield	GAC	N/A	Caustic	Ozone	N/A	N/A	Cation Exchange
South-Central Wellfield	⁽¹⁾ GAC	N/A	Caustic	N/A	N/A	N/A	Cation Exchange
Morris Bridge Wellfield	GAC	N/A	Caustic	N/A	N/A	N/A	Cation Exchange
Cypress Creek Wellfield	⁽¹⁾ GAC	N/A	Caustic	N/A	N/A	N/A	Cation Exchange
South Pasco Wellfield	GAC	N/A	Caustic	Chlorine	N/A	N/A	Cation Exchange
Section 21 Wellfield	GAC	Chlorine	Caustic	Chlorine	N/A	N/A	Cation Exchange
Cosme-Odesa Wellfield	GAC	N/A	Caustic	Ozone	N/A	N/A	Cation Exchange
Eldridge Wilde Wellfield	GAC	N/A	Caustic	Ozone	N/A	N/A	Cation Exchange
Starkey Wellfield	GAC	N/A	Caustic	Ozone	N/A	N/A	Cation Exchange

1. GAC operated in biological mode at lower predicted TOC percent removals

5. Opinion of Probable Construction Costs and Phasing Considerations

The opinion of probable capital and operating costs were based on Association for the Advancement of Cost Engineering (AACE) Class V (+50%/-20%) estimates. Using a Class V estimate is appropriate for screening alternatives and making high-level decisions.

5.1 Assumptions

General and site-specific assumptions were utilized to develop the engineer's opinion of probable construction cost (EOPCC) for the treatment process improvements to meet the target water quality and to compare the various technologies, which include:

- Annual average production at each source as indicated in Table 4-2 were used to develop the costs for TOC removal rather than the sustainable capacity of the entire source water. As a result, bypass flow was considered for each technology. In cases where removal of other water quality parameters was necessary, treatment was applied to the entire sustainable capacity.
- Major capital and O&M costs were obtained from vendors based on site capacity (MGD), water quality, and treatment goals.
- Each site was evaluated to determine if land acquisition was required. A unit cost per acre was assumed for land acquisition needs (\$/acre).
- Additional intermediate pumping for pressurized systems was not included in the planning level costs estimates.
- Waste stream flow generation was calculated as a percentage of treatment flow, where waste stream encompasses backwash and brine water for disposal. A flow dependent (\$/gpd) fee was utilized for a wastewater force main connection for disposal of backwash or brine streams. In addition to the connection fee, pipeline capital and operation and maintenance (O&M) costs were included.
- Due to the range in capacities and technologies, chemical dosing and costs were estimated on a site by site case.
- Capital costs associated with system redundancy were not included.
- O&M costs included chemical and power costs only.
- The costs for interconnecting piping, electrical, and instrumentation and control (I&C) were estimated as a percentage of equipment capital cost for each site.
- Historical flushing data was averaged and used alongside a cost of \$2.56 per 1,000 gal to estimate cost savings from reduced flushing volumes. The water rate was the unitary rate obtained from the Master Plan 2020 Budget.

- A contingency fee of 35% and an engineering, legal and administrative fee of 25% were utilized for the conceptual cost calculations.
- Amortization of the conceptual cost at each site was calculated based on a 6 percent interest rate and 30-year bond term.

Specific assumptions for each technology to develop the preliminary capital and operating and maintenance costs (O&M) include:

- GAC capital costs included the equipment, concrete costs (GAC basins only), and initial media load.
- Ion exchange system capital costs included the equipment and initial resin load.
- Cation exchange system O&M cost were designed around calcium removal goals.
- Anion exchange system O&M cost were designed around nitrate removal goals.
- Greensand system capital costs included filter pressure equipment, flow instrumentation, and filter system control panel in addition to the filter tank equipment and initial media load costs.
- Ozone systems capital costs included the LOX system and side stream system in addition to the ozone generation equipment costs.
- Shelter (open air metal building) and building costs were included to protect the equipment from the elements on a \$/ft² basis. All treatment options assumed a shelter with the exception of the ozone equipment, which is assumed to be installed within a building.
- Specific to the surface water plant, the backwash water stream from the GAC was assumed to be redirected to the headworks of the plant and thus no sewer disposal fee was included.
- For GAC, the costs of changeouts was assumed to be a flat fee per 40,000 lbs of carbon, with the frequency of changeouts varying based on site water quality and operating mode (GAC vs BAC).
- The O&M costs included for the greensand and ion exchange systems were chemical (Cl₂ and NaOCl) and salt for resin regeneration costs, respectively.
- The O&M costs included for the ozone system incorporated electrical, chemical (liquid oxygen), and pumping costs.

Table 5-1 highlights preliminary design criteria for the major components utilized for the cost estimate of the various technologies evaluated.

Table 5-1: Preliminary Design Criteria Summary

GAC/BAC Vessels	GAC Basins	Greensand	Ion Exchange	Ozone System ⁽¹⁾
Loading Rate 3.0 gpm/ft ²	Loading Rate 4.2 gpm/ft ²	Loading Rate 4.6 gpm/ft ²	Efficiency Factors Competing ions	Ozone Dose 10-15 mg/L
EBCT 15 min	EBTC 15 min	Chlorine Dose 2.9 mg/L Cl ₂	Backwash Flow 2% of Capacity	
Backwash Flow 5% of Capacity	Backwash Flow 3% of Capacity	Backwash Flow 5% of Capacity		

⁽¹⁾Formation of bromate from Ozone system will need to be evaluated in next steps.

5.2 Summary of Costs to Meet Water Quality Goals (Without Hardness)

Four cost scenarios were developed based on the model results for each source: (A) 2.0 mg/L TOC target, (B) 1.5 mg/L TOC target, (C) 1.25 mg/L TOC target, and (D) 1.0 mg/L TOC target. Each of these scenarios also accounted for treatment of the other water quality goals as previously discussed and referenced in Table 4-1. The data indicates that no additional TOC treatment nor treatment for other Exhibit D parameters was required at the Desalination Plant and Cypress Bridge Wellfield. Cypress Creek Wellfield did not require additional TOC treatment until Scenario C and D, however it required pH adjustment for each scenario. The Surface Water Plant and South-Central Wellfield did not require additional TOC treatment for Scenario A, but similarly required pH adjustment for each scenario. The resulting conceptual capital, O&M, present worth, and amortized total costs for each scenario are summarized in Table 5-2, with more detailed costs presented in Table 5-3 through Table 5-6. Estimated unitary rate increase values were calculated for each scenario based on the source total average flow presented in Table 3-2. The total annual amortized cost for each scenario was converted to a daily amortized cost. The daily amortized cost was then divided by the total average flow and converted to dollars per thousand gallons produced.

Table 5-2: Summary of Planning Level Costs for Each Scenario

Scenario	Capital Cost (\$)	Annual O&M Cost (\$/yr)	Present Worth Costs (Capital + O&M) (\$)	Amortized Cost (Capital + O&M) (\$/yr)	Estimated Unitary Rate Increase (\$/kgal)
A	\$126 M	\$5.0 M	\$198 M	\$14 M	0.22
B	\$166 M	\$10 M	\$305 M	\$22 M	0.33
C	\$192 M	\$11 M	\$360 M	\$25 M	0.39
D	\$208 M	\$13 M	\$405 M	\$29 M	0.44

Table 5-3: Cost Scenario A – 2.0 mg/L TOC Target

Site Name	Flow (MGD)	Capital Cost (\$)	Annual O&M Cost (\$/yr)	Present Worth Cost (Capital + O&M) (\$)	Amortized Cost (Capital + O&M) (\$/yr)
Cross Bar Wellfield	10	\$19 M	\$0.4 M	\$24 M	\$1.7 M
BUD5	3	\$8.6 M	\$0.06 M	\$9.6 M	\$0.7 M
BUD7	2	\$3.5 M	\$0.03 M	\$4.0 M	\$0.3 M
Northwest Hillsborough Wellfield	4	\$14 M	\$0.1 M	\$16 M	\$1.2 M
Morris Bridge Wellfield	10	\$9.8 M	\$0.6 M	\$19 M	\$1.4 M
South Pasco Wellfield	8	\$9.2 M	\$0.8 M	\$21 M	\$1.5 M
Section 21 Wellfield	4	\$4.4 M	\$0.3 M	\$8.7 M	\$0.6 M
Cosme-Odessa Wellfield	10	\$22 M	\$1.0 M	\$37 M	\$2.6 M
Eldridge Wilde Wellfield	11	\$22 M	\$1.1 M	\$38 M	\$2.7 M
Starkey Wellfield	5	\$13 M	\$0.6 M	\$21 M	\$1.5 M
Total	67	\$126 M	\$5.0 M	\$198 M	\$14 M

Table 5-4: Cost Scenario B – 1.5 mg/L TOC Target

Site Name	Flow (MGD)	Capital Cost (\$)	Annual O&M Cost (\$/yr)	Present Worth Cost (Capital + O&M) (\$)	Amortized Cost (Capital + O&M) (\$/yr)
Surface Water Treatment Plant (GAC)	64	\$24 M	\$3.8 M	\$81 M	\$5.6 M
Cross Bar Wellfield	10	\$19 M	\$0.4 M	\$24 M	\$1.7 M
BUD5	3	\$8.6 M	\$0.06 M	\$9.6 M	\$0.7 M
BUD7	2	\$3.5 M	\$0.03 M	\$4.0 M	\$0.3 M
Northwest Hillsborough Wellfield	4	\$16 M	\$0.1 M	\$17 M	\$1.3 M
South-Central Wellfield	20	\$4.0 M	\$0.06 M	\$4.9 M	\$0.4 M
Morris Bridge Wellfield	10	\$11 M	\$0.7 M	\$21 M	\$1.5 M
South Pasco Wellfield	8	\$11 M	\$1.0 M	\$26 M	\$1.8 M
Section 21 Wellfield	4	\$5.7 M	\$0.4 M	\$11 M	\$0.8 M
Cosme-Odessa Wellfield	10	\$24 M	\$1.1 M	\$41 M	\$2.9 M
Eldridge Wilde Wellfield	11	\$24 M	\$1.2 M	\$42 M	\$3.0 M
Starkey Wellfield	5	\$15 M	\$0.7 M	\$24 M	\$1.7 M
Total	151	\$166 M	\$9.6 M	\$305 M	\$22 M

Table 5-5: Cost Scenario C – 1.25 mg/L TOC Target

Site Name	Flow (MGD)	Capital Cost (\$)	Annual O&M Cost (\$/yr)	Present Worth Cost (Capital + O&M) (\$)	Amortized Cost (Capital + O&M) (\$/yr)
Surface Water Treatment Plant (GAC)	64	\$26 M	\$4.7 M	\$95 M	\$6.5 M
Cross Bar Wellfield	10	\$19 M	\$0.4 M	\$24 M	\$1.7 M
BUD5	3	\$8.6 M	\$0.06 M	\$9.6 M	\$0.7 M
BUD7	2	\$3.5 M	\$0.03 M	\$4.0 M	\$0.3 M
Northwest Hillsborough Wellfield	4	\$17 M	\$0.1 M	\$18 M	\$1.3 M
South-Central Wellfield	20	\$10 M	\$0.1 M	\$12 M	\$0.9 M
Morris Bridge Wellfield	10	\$16 M	\$1.1 M	\$32 M	\$2.3 M
Cypress Creek Wellfield	10	\$9.0 M	\$0.1 M	\$11 M	\$0.8 M
South Pasco Wellfield	8	\$12 M	\$1.1 M	\$28 M	\$1.9 M
Section 21 Wellfield	4	\$6.1 M	\$0.4 M	\$12 M	\$0.8 M
Cosme-Odessa Wellfield	10	\$24 M	\$1.2 M	\$42 M	\$3.0 M
Eldridge Wilde Wellfield	11	\$26 M	\$1.4 M	\$46 M	\$3.3 M
Starkey Wellfield	5	\$15 M	\$0.7 M	\$25 M	\$1.8 M
Total	161	\$192 M	\$11 M	\$360 M	\$25 M

Table 5-6: Cost Scenario D – 1.0 mg/L TOC Target

Site Name	Flow (MGD)	Capital Cost (\$)	Annual O&M Cost (\$/yr)	Present Worth Cost (Capital + O&M) (\$)	Amortized Cost (Capital + O&M) (\$/yr)
Surface Water Treatment Plant (GAC)	64	\$26 M	\$4.7 M	\$95 M	\$6.5 M
Cross Bar Wellfield	10	\$20 M	\$0.9 M	\$34 M	\$2.4 M
BUD5	3	\$8.6 M	\$0.06 M	\$9.6 M	\$0.7 M
BUD7	2	\$3.5 M	\$0.03 M	\$4.0 M	\$0.3 M
Northwest Hillsborough Wellfield	4	\$17 M	\$0.1 M	\$19 M	\$1.4 M
South-Central Wellfield	20	\$15 M	\$0.5 M	\$23 M	\$1.6 M
Morris Bridge Wellfield	10	\$17 M	\$1.2 M	\$34 M	\$2.4 M
Cypress Creek Wellfield	10	\$14 M	\$0.7 M	\$25 M	\$1.7 M
South Pasco Wellfield	8	\$13 M	\$1.1 M	\$29 M	\$2.1 M
Section 21 Wellfield	4	\$6.2 M	\$0.4 M	\$13 M	\$0.9 M
Cosme-Odessa Wellfield	10	\$26 M	\$1.4 M	\$46 M	\$3.2 M
Eldridge Wilde Wellfield	11	\$27 M	\$1.5 M	\$48 M	\$3.4 M
Starkey Wellfield	5	\$15 M	\$0.7 M	\$26 M	\$1.9 M
Total	161	\$208 M	\$13 M	\$405 M	\$29 M

5.3 Additional Costs to Meet Proposed Exhibit D Calcium Hardness Goal

Cation exchange systems were sized for each source based on source treatment goal and capacity for calcium hardness removal. Table 5-7 summarizes the capital, O&M, present worth, and amortized total costs estimated for the addition of calcium hardness treatment at identified sources.

Table 5-7: Summary of Estimated Calcium Removal Costs

Site Name	Flow (MGD)	Capital Cost (\$)	Annual O&M Cost (\$/yr)	Present Worth Cost (Capital + O&M)	Amortized Cost (Capital + O&M) (\$/yr)
Surface Water Treatment Plant (GAC)	64	\$32 M	\$3.2 M	\$77 M	\$5.6 M
Cross Bar Wellfield	10	\$6.1 M	\$0.48 M	\$13 M	\$0.9 M
BUD5	3	\$2.5 M	\$0.16 M	\$4.7 M	\$0.4 M
Northwest Hillsborough Wellfield	4	\$2.9 M	\$0.18 M0	\$5.4 M	\$0.4 M
South-Central Wellfield	20	\$7.7 M	\$0.77 M	\$18 M	\$1.3 M
Morris Bridge Wellfield	10	\$8.1 M	\$0.53 M	\$15 M	\$1.1 M
Cypress Creek Wellfield	10	\$6.9 M	\$0.48 M	\$13 M	\$1.0 M
South Pasco Wellfield	8	\$5.6 M	\$0.38 M	\$11 M	\$0.8 M
Section 21 Wellfield	4	\$3.1 M	\$0.19 M	\$5.8 M	\$0.4 M
Cosme-Odesa Wellfield	10	\$6.5 M	\$0.48 M	\$13 M	\$1.0 M
Eldridge Wilde Wellfield	11	\$7.1 M	\$0.53 M	\$14 M	\$1.1 M
Starkey Wellfield	5	\$3.9 M	\$0.24 M	\$7.2 M	\$0.5 M
Total	159	\$92 M	\$7.6 M	\$198 M	\$15 M

5.4 Phasing Consideration

One consideration, based on the required treatment and costs, is the ability to phase-in further TOC reductions in the future. Treatment systems incorporated to meet a treatment goal of 2.0 mg/L of TOC could be designed to account for future upgrades to achieve lower TOC levels in the future. Table 5-8 summarizes the incremental cost increase as the TOC levels are reduced for each scenario. For example, a 1 MGD BAC system could be initially installed at the South-Central Wellfield to achieve the 1.5 mg/L TOC target, which can be later expanded to an 8 MGD GAC system to achieve the 1.0 mg/L TOC target. This can be accomplished by installing more GAC vessels and switching the operating mode from biological to adsorption. Similarly, the Cross Bar Wellfield could initially install a 5 MGD greensand system to meet a TOC target of 1.25 mg/L, and later install a 5.5 MGD GAC system along with an additional 0.5 MGD of greensand capacity to meet the 1.0 mg/L TOC target.

Another approach could be initially installing full treatment at a specific location and potentially delaying treatment at another location since it may be more cost effective to install the infrastructure to treat to a higher-level up front. Phasing provides Tampa Bay Water and the member governments the opportunity to distribute the capital costs while reducing TOC levels in the system over time. Specific phasing concepts can be further evaluated as part of the next steps.

Table 5-8: Potential Phasing and Capital Cost Distribution (Without Hardness)

Site Name	Flow (MGD)	Scenario A 2.0 mg/L TOC	Scenario B 1.5 mg/L TOC	Scenario C 1.25 mg/L TOC	Scenario D 1.0 mg/L TOC
BUD5	3	\$8,600,000	\$8,600,000	\$8,600,000	\$8,600,000
BUD7	2	\$3,500,000	\$3,500,000	\$3,500,000	\$3,500,000
Cosme-Odesa Wellfield	10	\$22,000,000	\$24,000,000	\$24,000,000	\$26,000,000
Cross Bar Wellfield	10	\$19,000,000	\$19,000,000	\$19,000,000	\$20,000,000
Cypress Creek Wellfield	10	N/A	N/A	\$9,000,000	\$14,000,000
Eldridge Wilde Wellfield	11	\$22,000,000	\$24,000,000	\$26,000,000	\$27,000,000
Morris Bridge Wellfield	10	\$9,800,000	\$11,000,000	\$16,000,000	\$17,000,000
Northwest Hillsborough Wellfield	4	\$14,000,000	\$16,000,000	\$17,000,000	\$17,000,000
Section 21 Wellfield	4	\$4,400,000	\$5,700,000	\$6,100,000	\$6,200,000
South Pasco Wellfield	8	\$9,200,000	\$11,000,000	\$12,000,000	\$13,000,000
South-Central Wellfield	20	N/A	\$4,000,000	\$10,000,000	\$15,000,000
Starkey Wellfield	5	\$13,000,000	\$15,000,000	\$15,000,000	\$15,000,000
Surface Water Treatment Plant (GAC)	64	N/A	\$24,000,000	\$26,000,000	\$26,000,000
Total	161	\$125,500,000	\$165,800,000	\$192,200,000	\$208,300,000

5.5 Preliminary Cost-Benefit Analysis

Two of the drivers for the proposed water quality enhancements are improved water quality within the member governments distribution system and water conservation. With respect to water quality, the additional treatment may improve the regional potable water quality and disinfectant residual stability. With respect to water conservation, the enhanced water quality could decrease the frequency and duration of flushing events. A cost-benefit analysis was conducted to compare the pros and cons for each scenario as it relates to creating waste streams and potentially reducing the flushing.

The waste stream volume for each site was technology specific and estimated as a percentage of treated water volume. The predicted volumes for each site were then combined to obtain a total estimated waste stream volume for each scenario. To quantify the reduction in flushing volume and associated costs savings, historical member government flushing data from the past three years was averaged. The average volume of water flushed in a year was then multiplied by an estimated percent reduction based on the TOC target associated with each scenario. The estimated percentage volume reductions for 2.0, 1.5, 1.25, and 1.0 mg/L of TOC were approximately 25%, 32%, 42%, and 50%, respectively since it is assumed that reduction of TOC alone will not eliminate the need for flushing. For example, dead end areas or sections with extended residence times would remain as inherent distribution system design and operations issues, which cannot be solved alone by TOC reduction. The calculated volume, in gallons, was then multiplied by the Master Plan 2020 Budget unitary rate of \$2.56/kgal to estimate potential annual costs savings.

A summary of the estimated annualized costs, potential waste streams from the identified treatment processes, and the potential impacts on member government flushing volumes and costs are included in Table 5-9.

Table 5-9: Scenario Based Cost-Benefit Analysis

Scenario	Estimated Amortized Total Treatment Cost ⁽¹⁾ (\$/yr)		Estimated Waste Stream Generation (MG/yr)		Potential Benefit Reduced Flushing	
	Parameters (except Ca+) ⁽²⁾	Calcium Hardness Only ⁽³⁾	Parameters (except Ca+) ⁽²⁾	Calcium Hardness Only ⁽³⁾	Volume Reduction (MG/yr)	Cost Savings (\$/yr)
A	\$14 M	\$15 M	600	580	450	\$1.1 M
B	\$22 M	\$15 M	720	580	580	\$1.4 M
C	\$25 M	\$15 M	950	580	760	\$1.9 M
D	\$29 M	\$15 M	1,130	580	900	\$2.3 M

1. Amortized costs represent the summation of capital and operation and maintenance costs spread over a 30-year period at 6 percent interest.
2. Initial treatment selection refers to the costs associated to the technologies selected to address the proposed TOC, iron, pH, sulfide, nitrate, and nitrite Exhibit D goals
3. Additional costs to incorporate calcium hardness treatment.
4. Additional waste stream volume generation due to calcium hardness treatment.





















Based on these estimates, cost savings from reduced flushing volumes would not be sufficient to justify enhanced water quality treatment. While TOC reduction reduces flushing, it will not eliminate it because dead ends or sections with extended residence times remain as inherent distribution system design and operations issues, which cannot be solved alone by TOC reduction. Additionally, enhanced water quality treatment requires additional water supply (2 to 5 MGD) as well as processing and proper disposal of waste streams such as filter backwash waters and brine for calcium hardness treatment, if selected.

The advanced treatment objective is to provide a more consistent delivery of a higher quality water to Member governments with improved disinfectant residual stability and further reduction of DBPs, nitrification, and potential taste and odor events; ultimately, leading to enhanced water quality to all customers in the Tampa Bay Water region.

6. Summary of Findings and Next Steps

Table 6-1 summarizes the overall potential water quality benefits for each scenario as TOC and other water quality parameters are reduced. In addition to reduced flushing, each scenario should positively impact water quality at each POC. The stability of the disinfectant residual and TTHM formation improve as TOC concentration is reduced, with the most significant improvement predicted for Scenario D. Although the most benefit is estimated for Scenario D, Scenario A is also estimated to reduce the disinfectant residual decay rate and THM formation potential. Additional water quality improvements that could be observed include reduced taste and odor events, reduction in the potential for nitrification, and a reduction in water hardness.

Table 6-1: Summary of Water Quality Benefits

Scenario	Potential Water Quality Benefits ⁽¹⁾				
	Residual Stability	THM Formation	Taste & Odor ⁽²⁾	Nitrification Potential	Hardness
A					
B					
C					
D					

1. Full circle represents maximum benefit and quarter circle represents minimum benefit.
2. Taste and odor impacts are not exclusively tied to TOC reduction; however, some TOC removal processes also address sources of taste and odor.

In general, the following are the potential overall water quality benefits based on the findings from the study:

- Reducing TOC is expected to improve water quality and provide a more consistent supply throughout the region, reducing the need for additional treatment (i.e. disinfection boost) by each member government in response to TOC and other water quality variables.
- Improving regional water quality should help the member governments manage water quality in their distribution systems by increasing the residual stability and reducing potential for taste and odor, while decreasing flushing.
- Lower TOC levels will reduce DBP formation during free chlorine burns or if a free chlorine residual is maintained within the system.
- The extent of water quality improvements increases as the TOC level is reduced.

Based on the findings of this study and the overall approach, the following are the recommended next steps:

- Collect additional water quality data needed to update the system model and assumptions.
- Work with member governments to confirm residence times in the member government distribution systems to verify potential impacts on trihalomethane formation.
- Continue to refine the model by collecting additional water quality data to confirm basic assumptions.
- Perform bench/pilot studies on the potential treatment technologies to confirm the design criteria and costs.
- Further evaluate ability to phase the level of treatment and impact on required timing of treatment.
- Further evaluate any potential impacts on member government corrosion control strategies.

It is recommended that these next steps be completed before finalizing treatment locations and technologies. Once finalized and approved, treatment would be installed in phases at the recommended locations to demonstrate success under various source water conditions before modifying Exhibit D. Table 6-2 summarizes the anticipated activities and approximate timing of these future activities.

Table 6-2 Approximate Timing of Next Steps ⁽¹⁾

Action Item	Estimated Completion Date
Board Approved Study and Next Steps	December 2019
Complete additional studies, including sampling, confirmation of residence times, and bench/pilot tests	December 2020
Confirm/finalize treatment locations and costs (update model)	June 2021
Board Approved Recommendations for Treatment Projects	December 2021
Design and Construction of Improvements ⁽²⁾	30 - 60 months from Board Authorization
Operational Period to Confirm Results	12 months after construction
Board Approved Modification of Exhibit D based on Findings	6 months after operational period

Note: 1. Schedule is contingent on study findings and necessary approvals.
 2. Depends on the extent and phasing of Board approved treatment

Appendix A: 2017 Member Government Recommendations

Water Quality Standards
2017 MG Recommendations
July 31 2018

Parameter	Units	Existing	Pasco	Hillsborough	Tampa	St Pete	Pinellas*	NPR	For Study	Priority
Conductivity	mhos/cm (max avg)	850				670				
Temp	deg C (max avg)	35				35				
Alkalinity	mg/L as CaCO3 (min avg)	100	100	100		120-150	100			
Sulfide	mg/L (max avg)	0.1		BDL		0.02			0.02	4
Hardness	mg/L as CaCO3 (min avg)	300				120-165	100		150	4
Ca Hardness	mg/L as CaCO3 (min avg)	50				105				
Ca Hardness	mg/L as CaCO3 (max avg)	250	100	100		165			100	4
TOC	mg/L (max avg)	4.6	2.0	0.4		1	0.8		1	1
TOC	mg/L (max)	6.5							2	1
Iron	mg/L (max avg)	0.3	BDL	BDL		0.05	BDL		0.05	3
Turbidity	NTU (max avg)	1.0	1.0			1				
Color	CU (max)	15.0	5.0	5		5	0.5-5.0		5	2
Fluoride	mg/L (max avg)	0.8				0.6-0.8	0.7			
pH	SU (min avg)	7.0	7.8-8.2			7.8-8.3	7.8-8.0		7.8-8.3	4
Nitrite	mg/L as N (max avg)	1.0				0.05			0.05	4
Nitrate	mg/L as N (max avg)	10.0				0.4			0.4	4
TDS	mg/L (max avg)	500				400	500		400	4
Ammonia	mg/L as N (max avg)	1.0	0.15			0.02	0.02		0.02	4
Orthophosphate	mg/L as P (max avg)	1.0								

Add'l

Chlorine Demand	mg/L (max avg)	No range noted			Add				Add	5
DBP Formation Potential		No range noted			Add				Add	5
Odor	TON	Not included			Add				3	5
Sulfate	mg/L (max avg)	20-250				30				
Chloride	mg/L (max avg)	35-250				20				
Free Chlorine	mg/L (max avg)	No range noted				3-4				

* - Pinellas: "All other primary and secondary standards at or below detection limit, begin sampling for select unregulated contaminants"

Appendix B: Level-1 Well Sampling Protocol

Hazen *Technical Memorandum*

November 26, 2018

To: Stephen Fleischacker, Water Quality Services Senior Manager, Tampa Bay Water

From: Christine Owen, Director of Water and Reuse Innovation, Hazen and Sawyer

Technical Memorandum

Sampling Protocol for the Tampa Bay Water Total Organic Carbon Evaluation Project

All sampling will be performed by the Tampa Bay Water Laboratory Staff. The Tampa Bay Water Laboratory is a NELAC certified laboratory and, as such, has NELAC approved protocols for the collection and analyses of all the analytes for which they maintain certification. It is recommended that all the samples collected for this project adhere to those laboratory sampling and analytical procedures. Proper NELAC COC and documentation will be sufficient for use in this project.

- For wells that have been running in the past 24 hours but are not running at the time of collection, please run the well for a period of time to clear the well casing three times. Ten minutes will be sufficient.
- For wells that have not been running for more than 24 but less than 72 hours, run the well for 30 minutes prior to sampling.
- For wells that have been off line for longer than 72 hours (up to two weeks), please run the well for 45 minutes prior to sampling.
- For wells that have been off line longer than two weeks, run the well for one hour prior to sampling at a minimum.

For the florescence work which will be performed by Hazen and Sawyer staff, 500 ml samples collected in amber glass bottles with no head space will be needed. Samples should be kept on ice or refrigerated until picked up by Hazen staff. Please notify Hazen staff by email when samples can be picked up. Email addresses to notify are:

Paul Biscardi pbiscardi@hazenandsawyer.com

Chris Owen cowen@hazenandsawyer.com

Andre Dieffenthaler adieffenthaler@hazenandsawyer.com

If you have any questions or concern, please contact me at 813-682-1215 or by email noted above.

Appendix C: Level-2 THMFP Test Protocol

Hazen *Memorandum*



November 29, 2018

To: Steve Fleischacker, Steve Foster, Jun Kim, PhD

From: Andre Dieffenthaler, PE
 Paul Biscardi, PhD, PE
 Christine Owen

cc: Jack Thornburgh
 Bill Becker

Re: Tampa Bay Water TOC Evaluation – DBPFP and Chlorine Residual Protocol (TBW PO# 20190150)

This memorandum outlines the recommended DBP formation potential and free chlorine residual decay testing protocol for Task 3. While quality control procedures are not detailed out in this document, it is assumed Tampa Bay Water will follow their standard QA/QC protocols for DBPFP and chlorine residual testing. This protocol is intended to serve as a simplified version of Standard Methods (SM) 5710B. If during review of the results, some of our simplifying assumptions appear invalid (i.e. highly variable pH, or abnormally rapid chlorine decay, etc.) we may request that said samples are re-run under alternative testing parameters to capture additional detail which more closely follows SM 5710B.

Testing Protocol:

1. Record initial sample pH and temperature.
2. Dose raw water sample with 15 mg/L sodium hypochlorite. Divide sample into four aliquots that will allow the measurement of pH and free chlorine at 2 minutes, 24 hours and 48 hours and then the final measurements at 7 days.
3. Incubate samples at 25° C at ambient pH under dark lighting.
4. Take measurements of the WQ parameters at the following incubation times where marked with an (X):

Incubation Time	pH	Free chlorine residual	TTHM (with speciation)
2 minutes	X	X	
24 hours	X	(if no chlorine residual is detected at 24 hours, start over at step 1 with a new sample volume)	
48 hours	X	X	
7 days	X	X	X

Job no

Appendix D: Level-3 SDS Test Protocol

Hazen *Memorandum*



June 28, 2019

To: Steve Fleischacker, Steve Foster, Jun Kim, PhD
From: Andre Dieffenthaler, PE
Paul Biscardi, PhD, PE
Christine Owen
cc: Jack Thornburgh

Re: Tampa Bay Water TOC Evaluation – DBPFP and Chlorine Residual Protocol (TBW PO# 20190150)

This memorandum outlines the recommended Simulated Distribution System (SDS) and chlorine residual decay testing protocol for Task 5. While quality control procedures are not detailed out in this document, it is assumed Tampa Bay Water will follow their standard QA/QC protocols for DBP analysis and chlorine residual testing. This protocol is intended to serve as a simplified version of Standard Methods (SM) 5710B. If during review of the results, some of our simplifying assumptions appear invalid (i.e. highly variable pH, or abnormally rapid chlorine decay, etc.) we may request that said samples are re-run under alternative testing parameters.

Sample Preparation

1. Conduct dilutions with TOC-free DI water to generate three samples:
 - a. Raw water (undiluted sample)
 - b. 50% Dilution (50% raw and 50% DI water by volume)
 - c. 75% Dilution (25% raw and 75% DI water by volume)

Testing Protocol (Free Chlorine):

1. Record initial sample pH and temperature.
2. Dose raw water sample with sodium hypochlorite to reach a free chlorine residual between 4 mg/L and 5 mg/L free Cl₂. Divide sample into six aliquots that will allow the measurement of pH and free chlorine at 2 minutes, 4-8 hours, 24 hours, 48 hours and then the final measurements at 7 days.
3. Incubate samples at 25° C at ambient pH in an empty cooler.
4. Take measurements of the WQ parameters at the following incubation times where marked with an (X):

Job no



June 28, 2019

Incubation Time	pH	Free chlorine residual	TTHM
2 minutes	X	X	
6 hours	X	X (if chlorine residual is less than 2.0 mg/L, start over at step 1 with a new sample volume and increase dose)	
24 hours	X	X	X
48 hours	X	X	X
3 days	X	X	X
7 days	X	X	X

Testing Protocol (Chloramines):

1. Record initial sample pH and temperature.
2. Dose raw water sample with sodium hypochlorite to reach a *free* chlorine residual between 4 mg/L and 5 mg/L free Cl₂.
3. Wait 1 min 30 sec before adding the ammonium hydroxide.
4. Add ammonia hydroxide at a 5:1 ratio (Cl₂/N ratio by weight) to apply the correct ammonium hydroxide dose.
5. Confirm a *total* chlorine residual of 4 to 5 mg/L.
6. If total chlorine residual is less than 4 mg/L go back to step 2 with a new sample and increase the chlorine dose.
7. Divide sample into six aliquots that will allow the measurement of pH and total chlorine at 2 minutes, 4-8 hours, 24 hours, 48 hours and then the final measurements at 7 days.
8. Incubate samples at 25° C at ambient pH in an empty cooler.
9. Take measurements of the WQ parameters at the following incubation times where marked with an (X):

Incubation Time	pH	Total chlorine residual	TTHM
2 minutes	X	X	
6 hours	X	X (if chlorine residual is less than 2.0 mg/L, start over at step 1 with a new sample volume and increase dose)	
24 hours	X	X	X
48 hours	X	X	X
3 days	X	X	X
7 days	X	X	X

Appendix E: System Model Results

Summary of Proposed Treatment at each Source - % Removal

Source	Parameter and Exhibit D Potential Revision									
	TOC	TOC	TOC	TOC	Iron	Sulfide	pH	Nitrate	Nitrite	Calcium Hardness
	<1.0 mg/l	<1.25 mg/l	<1.5 mg/l	<2 mg/l	<0.05 mg/l	<0.02 mg/l	7.8 < 8.3	<0.4 mg/l	<0.05 mg/l	<100 mg/l CaCO3
Desalination	0%	0%	0%	0%	0%	0%*	2% increase	0%	0%	0%
Surface Water	50%	50%	45%	0%	0%	0%*	2% increase	0%	0%	55%
South-Central Hillsborough Wellfield	40%	25%	5%	0%	0%	99%**	6% increase	0%	0%	50%
Brandon 5	0%	0%	0%	0%	0%	0%*	9% increase	60% at BUD4 and BUD 6	0%	60%
Brandon 7	0%	0%	0%	0%	0%	0%*	0%	87%	0%	0%
Morris Bridge Wellfield	85%	80%	50%	45%	0%	0%*	11% increase	0%	0%	60%
Cypress Bridge Wellfield	0%	0%	0%	0%	0%	0%*	0%*	0%	0%	0%
Cross Bar Ranch Wellfield	55%	0%	0%	0%	50%	0%*	10% increase	0%	0%	50%
Cypress Creek Wellfield	55%	25%	0%	0%	0%	0%*	10% increase	0%	0%	50%
South Pasco Wellfield	80%	75%	70%	55%	0%	90%**	8% increase	0%	0%	50%
Section 21 Wellfield	75%	65%	60%	45%	35%	81%	8% increase	0%	50% at NWH7 and S215	50%
Northwest Hillsborough Wellfield	70%	65%	55%	40%	0%	97%	10% increase	0%	0%	45%
Cosme-Odesa Wellfield	80%	70%	65%	55%	0%	96%	10% increase	0%	0%	50%
Eldridge Wilde Wellfield	80%	75%	65%	55%	0%	98%***	8% increase	0%	0%	50%
Starkey Wellfield	80%	75%	70%	60%	0%	98%	10% increase	0%	0%	50%

*existing treatment is already sufficient

**existing treatment will be enhanced

***existing treatment will be replaced

Existing TOC - Sources

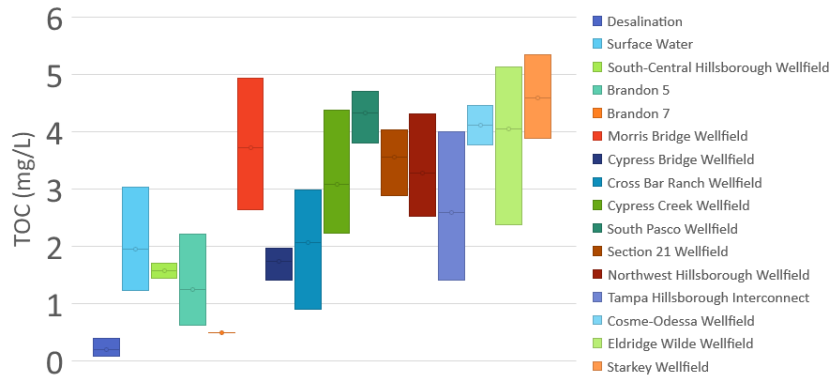

Existing TOC - Delivery

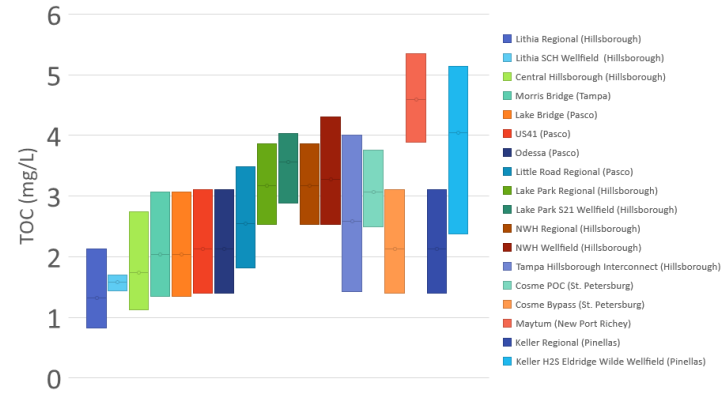

Potential Revised TOC < 1 mg/l - Sources

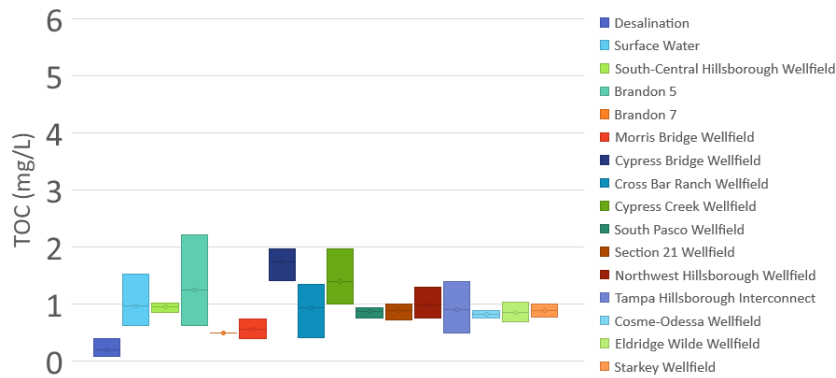

Potential Revised TOC < 1 mg/l - Delivery

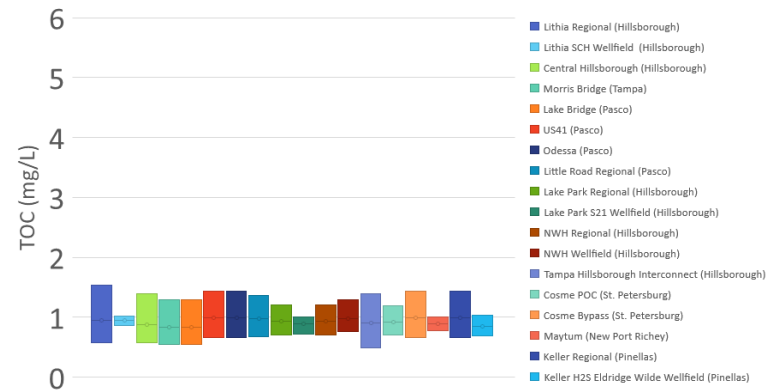

Potential Revised TOC < 1.25 mg/l - Sources

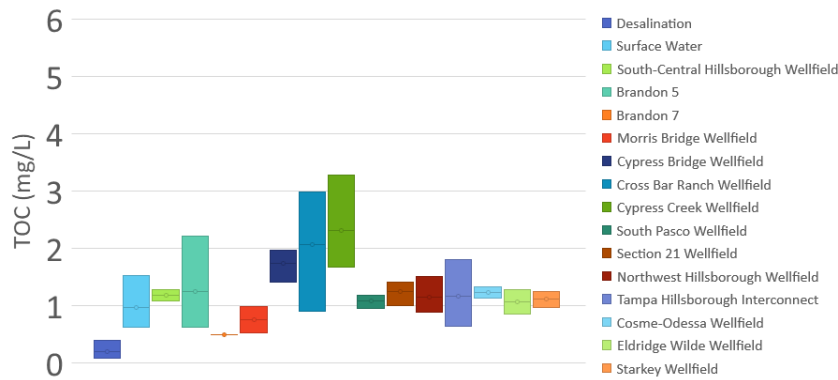

Potential Revised TOC < 1.25 mg/l - Delivery

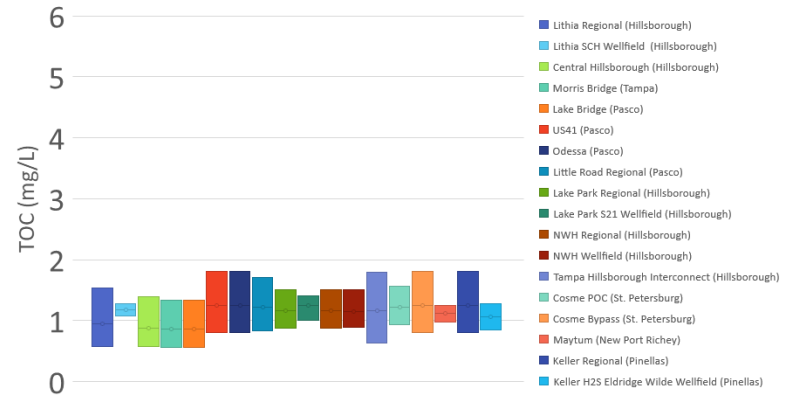

Potential Revised TOC < 1.5 mg/l - Sources

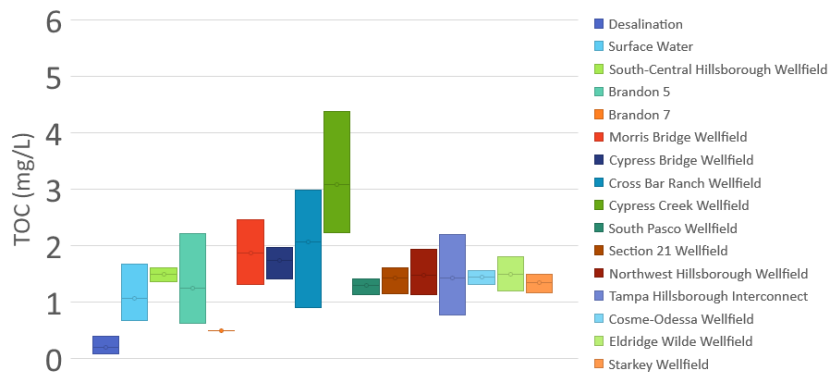

Potential Revised TOC < 1.5 mg/l - Delivery

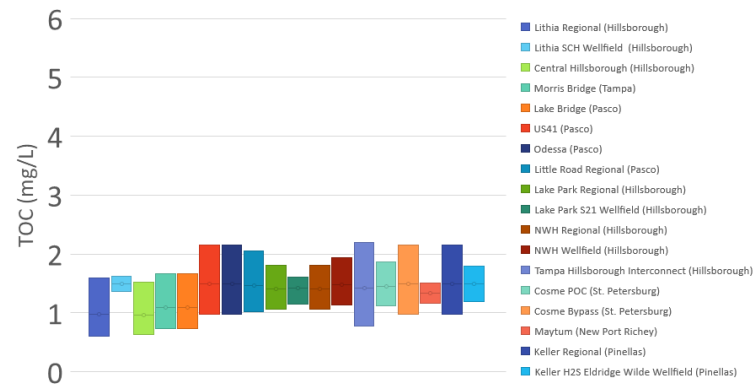

Potential Revised TOC < 2 mg/l - Sources

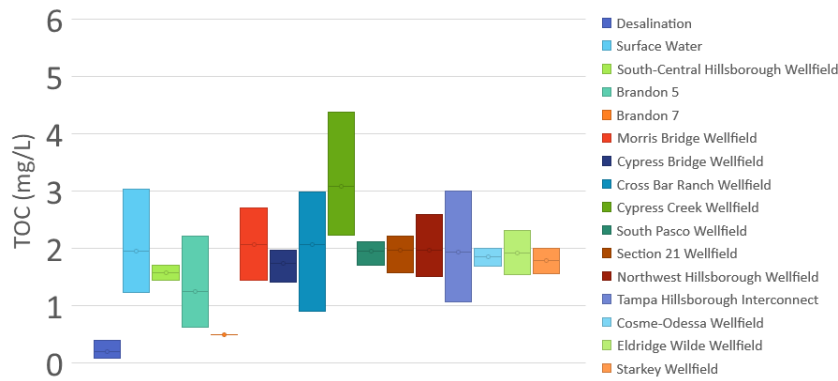

Potential Revised TOC < 2 mg/l - Delivery

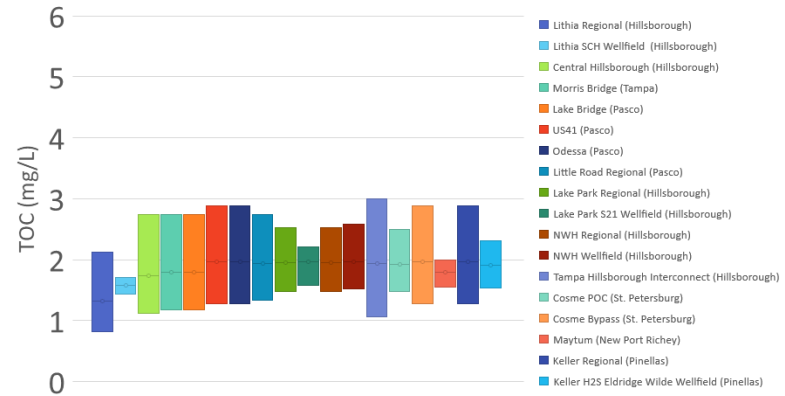

Existing Iron - Sources

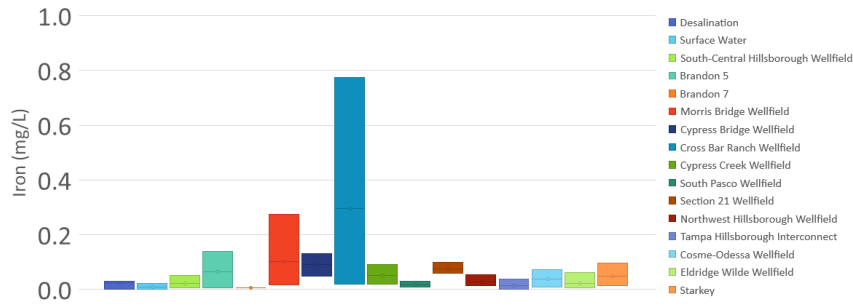

Existing Iron - Delivery

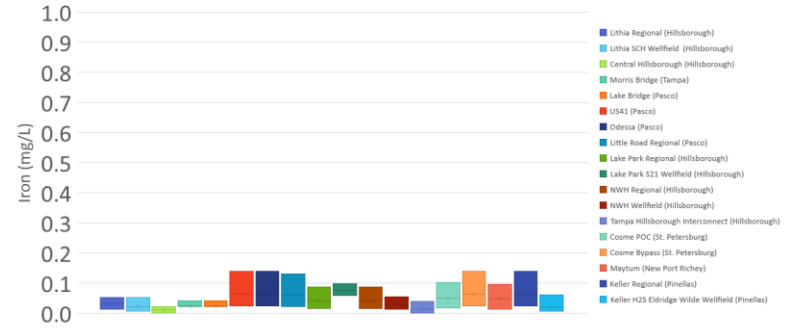

Potential Iron Revision < 0.05 mg/l - Sources

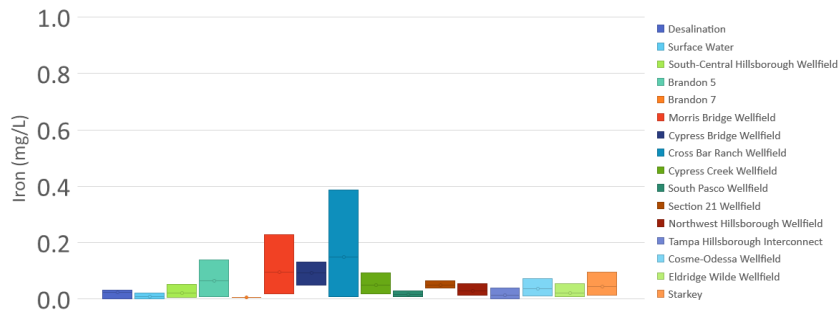

Potential Iron Revision < 0/05 mg/l - Delivery

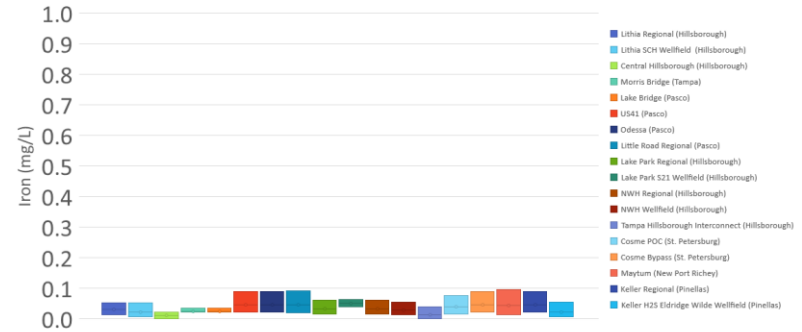

Tampa Bay Water
 Evaluation of Exhibit D Water Quality
 Final Report

Existing Sulfide - Sources

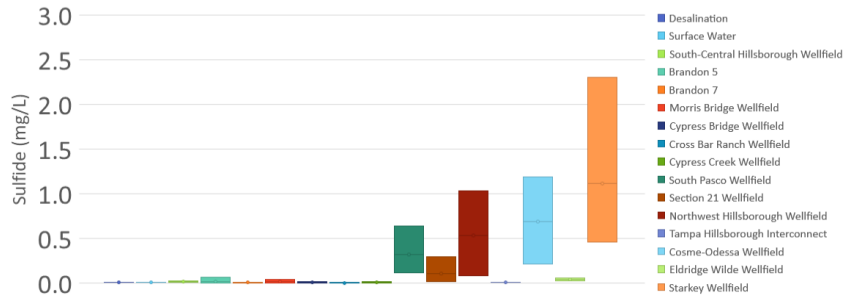

Existing Sulfide - Delivery

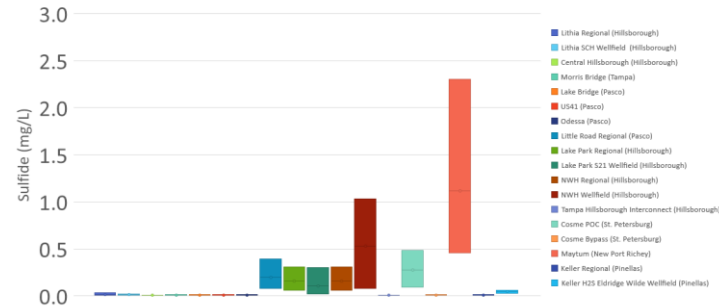

Potential Sulfide Revision < 0.02 mg/l - Sources

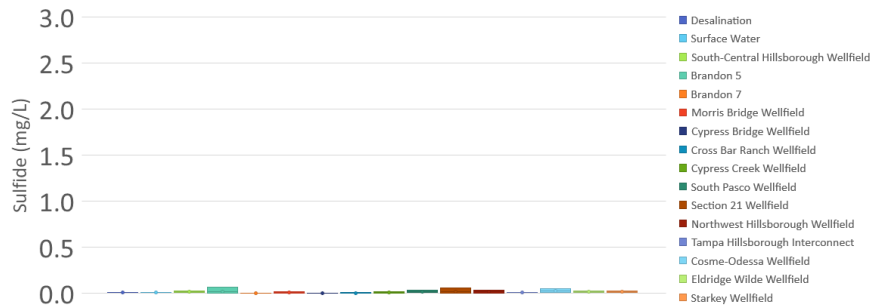

Potential Sulfide Revision < 0.02 mg/l - Delivery



Tampa Bay Water
 Evaluation of Exhibit D Water Quality
 Final Report

Existing pH - Sources

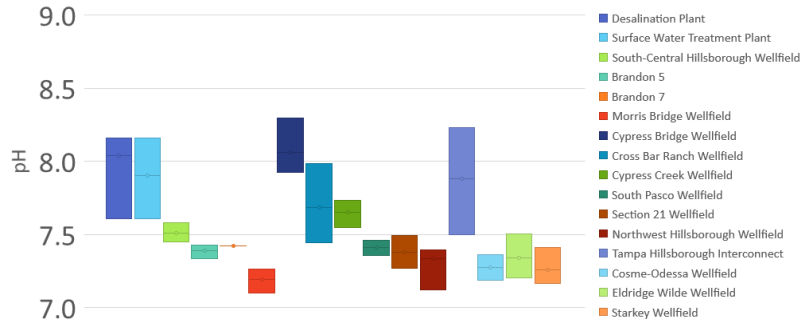

Existing pH - Delivery

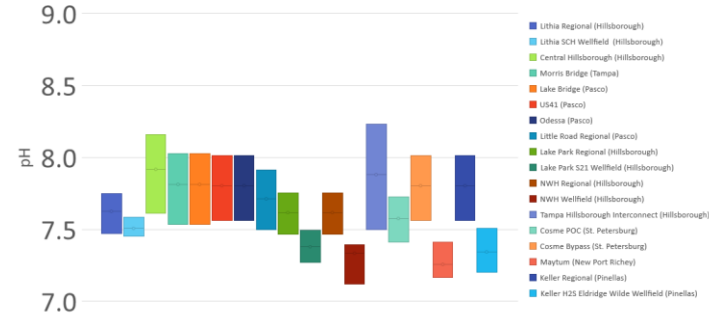

Potential pH Revision 7.8-8.3 - Sources

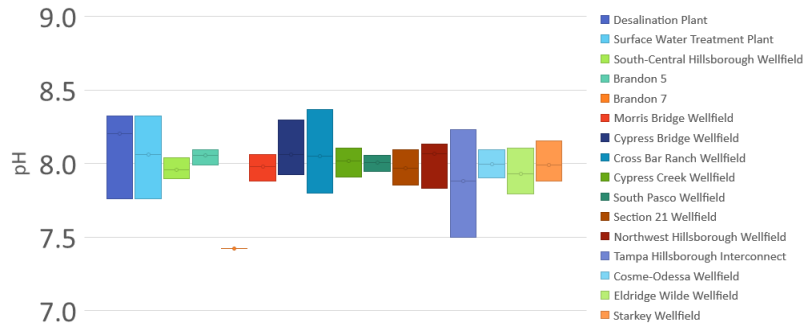

Potential pH Revision 7.8-8.3 - Delivery

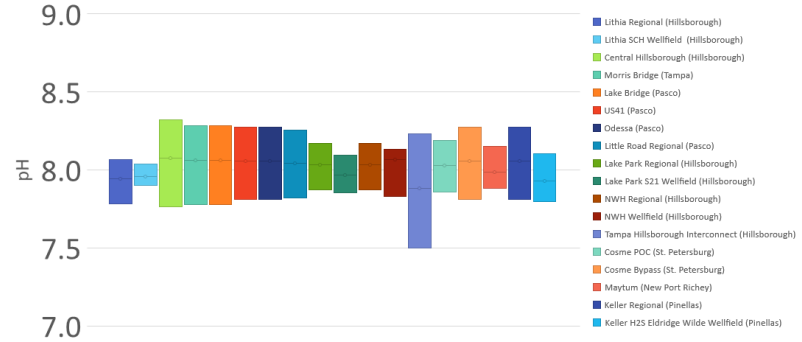

Existing Nitrate - Sources

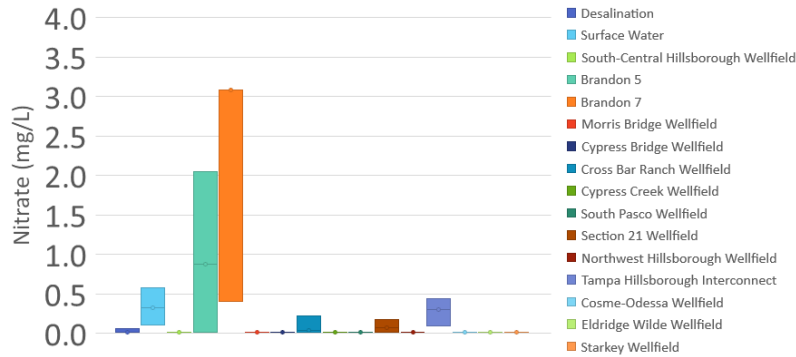

Existing Nitrate - Delivery

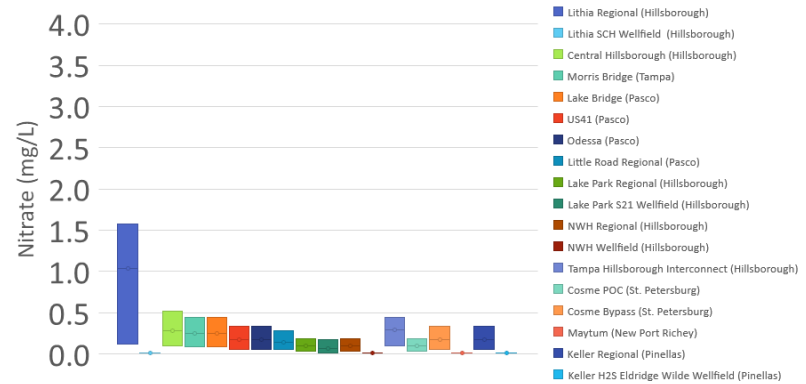

Potential Nitrate Revision 0.4 mg/l - Sources

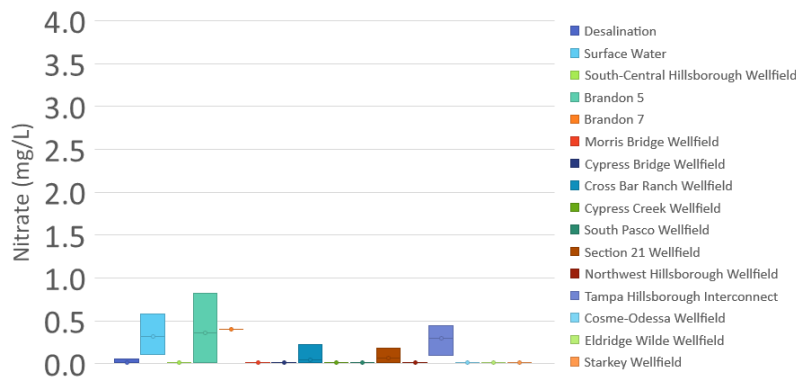

Potential Nitrate 0.4 mg/l - Delivery

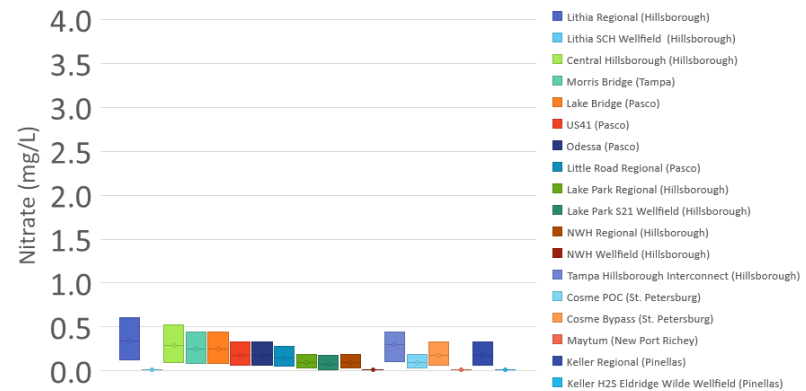

Existing Nitrite - Sources

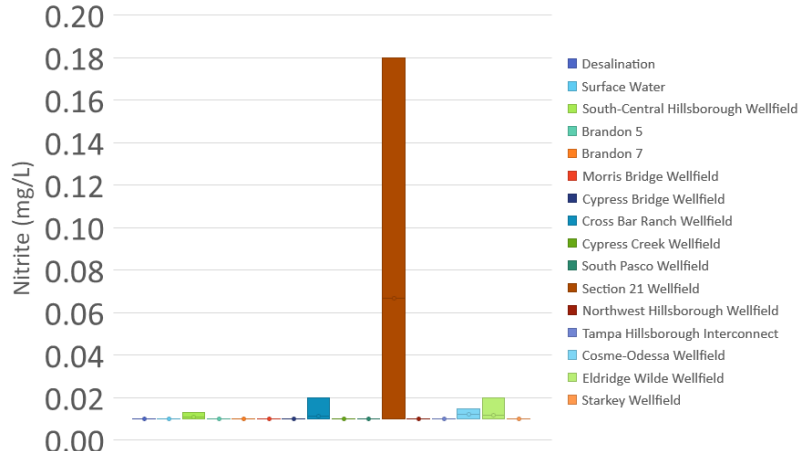

Existing Nitrite - Delivery

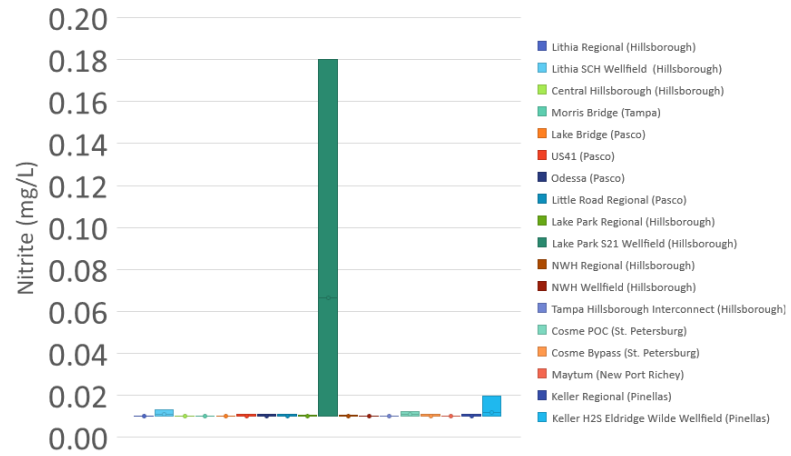

Potential Nitrite Revision 0.05 mg/l - Sources

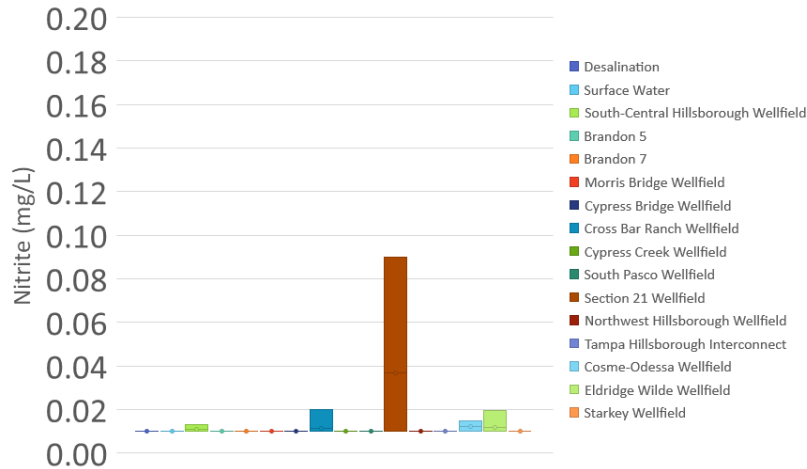

Potential Nitrite Revision 0.05 mg/l - Delivery

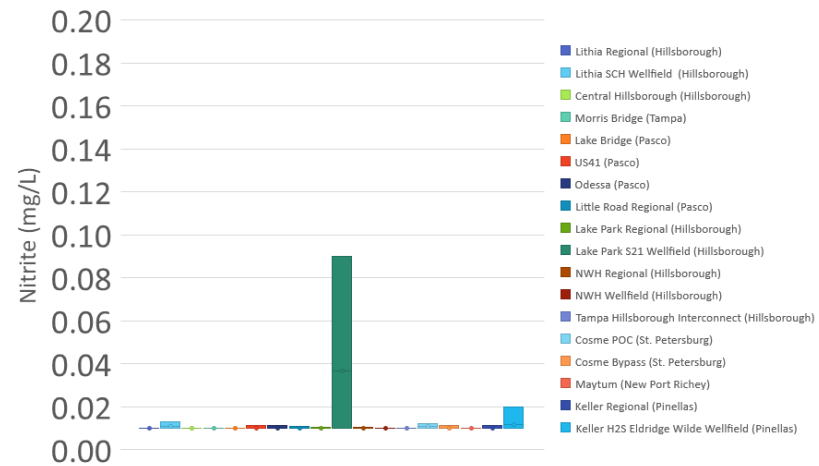

Appendix F: Level-1 & Level-2 Groups

Wellfield	Individual Groundwater Well	Level-1 Group	Level-2 Group
BUD	BUD-2	1-1	1-1
BUD	BUD-4	1-2	1-2
BUD	BUD-5R	1-3	1-3
BUD	BUD-6	1-2	1-2
BUD	BUD-7	1-4	1-4
CBR	CB1	2-9	2-9
CBR	CB2	2-10	2-8
CBR	CB3	2-1	2-1
CBR	CB4	2-1	2-1
CBR	CB5	2-1	2-1
CBR	CB6	2-1	2-1
CBR	CB7	2-8	2-8
CBR	CB8	2-1	2-1
CBR	CB9	2-1	2-1
CBR	CB10	2-2	2-1
CBR	CB11	2-5	2-5
CBR	CB12	2-6	2-6
CBR	CB13	2-5	2-5
CBR	CB14	2-3	2-3
CBR	CB15	2-7	2-7
CBR	CB16	2-4	2-4
CBR	CB17	2-3	2-3
CYC	CC1	3-1	3-1
CYC	CC2	3-2	3-2
CYC	CC3	3-3	3-3
CYC	CC4	3-4	3-1
CYC	CC5	3-4	3-1
CYC	CC6	3-6	3-3
CYC	CC7	3-7	3-2
CYC	CC8	3-7	3-2
CYC	CC9	3-7	3-2
CYC	CC10	3-8	3-4
CYC	CC11	3-9	3-5
CYC	CC12	3-10	3-3
CYC	CC13	3-10	3-3
COS	CO-1	4-8	4-1
COS	CO-3A	4-3	4-3

Tampa Bay Water
 Evaluation of Exhibit D Standards
 Final Report

Wellfield	Individual Groundwater Well	Level-1 Group	Level-2 Group
COS	CO-5	4-3	4-3
COS	CO-6A	4-9	4-3
COS	CO-7A	4-1	4-1
COS	CO-8	4-4	4-1
COS	CO-9	4-3	4-3
COS	CO-10	4-10	4-5
COS	CO-12A	4-9	4-3
COS	CO-16	4-6	4-2
COS	CO-18	4-8	4-1
COS	CO-20	4-3	4-3
COS	CO-21	4-2	4-2
COS	CO-24	4-9	4-3
COS	CO-25	4-5	4-5
COS	CO-30	4-12	4-5
COS	CO-31	4-7	4-4
COS	CO-32	4-4	4-1
COS	CO-34	4-11	4-1
CWD	CRLWD1	5-1	5-1
CWD	CRLWD2	5-2	5-1
CWD	CRLWD3	5-3	5-1
CYB	CY1	Offline	Offline
CYB	CY2	6-1	6-1
CYB	CY4	6-1	6-1
CYB	CY5	6-1	6-1
CYB	CY6	6-5	6-3
CYB	CY7	6-5	6-3
CYB	CY8	6-2	6-2
CYB	CY9	6-3	6-1
CYB	CY10	6-5	6-3
CYB	CY11	6-4	6-1
ELW	ELW9	7-18	7-2
ELW	ELW10A	7-19	7-4
ELW	ELW11A	Offline	Offline
ELW	ELW12	Offline	Offline
ELW	ELW13	7-20	7-5
ELW	ELW101	7-2	7-1
ELW	ELW102	7-3	7-3
ELW	ELW103	7-4	7-1
ELW	ELW104	7-5	7-1

Tampa Bay Water
 Evaluation of Exhibit D Standards
 Final Report

Wellfield	Individual Groundwater Well	Level-1 Group	Level-2 Group
ELW	ELW105	7-1	7-1
ELW	ELW106	7-5	7-1
ELW	ELW107	7-5	7-1
ELW	ELW109	7-6	7-6
ELW	ELW110	7-6	7-6
ELW	ELW112	7-7	7-3
ELW	ELW113	7-8	7-6
ELW	ELW114	7-9	7-6
ELW	ELW115	Offline	Offline
ELW	ELW116	7-10	7-7
ELW	ELW120	7-11	7-6
ELW	ELW121	7-12	7-8
ELW	ELW122	7-11	7-6
ELW	ELW131	7-12	7-9
ELW	ELW134	7-12	7-10
ELW	ELW135	7-13	7-11
ELW	ELW136	7-13	7-12
ELW	ELW137	7-14	7-6
ELW	ELW138	Offline	Offline
ELW	ELW139	7-15	7-6
ELW	ELW140	7-16	7-3
ELW	ELW141	7-16	7-3
ELW	ELW142	7-17	7-3
MBR	MB150	8-3	8-3
MBR	MB151	8-3	8-3
MBR	MB152	8-1	8-1
MBR	MB153	8-2	8-2
MBR	MB154	8-4	8-2
MBR	MB155	8-5	8-2
MBR	MB156	8-6	8-4
MBR	MB157	8-7	8-2
MBR	MB158	8-8	8-5
MBR	MB159	8-9	8-6
MBR	MB160	8-9	8-6
MBR	MB161	8-10	8-7
MBR	MB162	8-11	8-8
MBR	MB163	8-11	8-8
MBR	MB164	8-12	8-9
MBR	MB165	8-12	8-9

Tampa Bay Water
 Evaluation of Exhibit D Standards
 Final Report

Wellfield	Individual Groundwater Well	Level-1 Group	Level-2 Group
MBR	MB166	8-13	8-10
MBR	MB167	8-14	8-11
MBR	MB168	8-14	8-11
MBR	MB169	Offline	Offline
NWH	NWH1	9-1	9-1
NWH	NWH2	9-2	9-2
NWH	NWH3	9-3	9-3
NWH	NWH4	9-3	9-3
NWH	NWH5	9-4	9-4
NWH	NWH6	9-5	9-5
S21	NWH7	10-1	10-1
S21	S-21-#5	10-2	10-2
S21	S-21-#6	10-2	10-2
S21	S-21-#8	10-3	10-1
S21	S-21-#9	10-3	10-1
S21	S-21-#10	10-4	10-1
SCH	SCH1	11-1	11-1
SCH	SCH2	11-2	11-2
SCH	SCH3	11-3	11-2
SCH	SCH4	11-3	11-2
SCH	SCH5	11-4	11-2
SCH	SCH6	11-4	11-2
SCH	SCH7	11-5	11-1
SCH	SCH8	11-10	11-2
SCH	SCH9	11-6	11-2
SCH	SCH10	11-6	11-2
SCH	SCH11	11-7	11-7
SCH	SCH12	11-7	11-7
SCH	SCH13	11-7	11-7
SCH	SCH14	11-8	11-8
SCH	SCH15	11-7	11-7
SCH	SCH16	11-9	11-9
SCH	SCH17	11-7	11-7
SOP	SP-41	12-1	12-1
SOP	SP-43	12-2	12-1
SOP	SP-44	12-2	12-1
SOP	SP-46	12-1	12-1
SOP	SP-47	12-3	12-3
SOP	SP-48	12-3	12-3

Tampa Bay Water
 Evaluation of Exhibit D Standards
 Final Report

Wellfield	Individual Groundwater Well	Level-1 Group	Level-2 Group
SOP	SP-49	12-3	12-3
SOP	SP-50	12-4	12-1
STK	ST3	13-1	13-1
STK	ST4	13-6	13-4
STK	ST6	13-3	13-3
STK	ST7	13-7	13-4
STK	ST8	13-4	13-4
STK	ST9	13-5	13-5
STK	ST10	13-4	13-4
STK	ST12	Offline	Offline
STK	ST15	Offline	Offline
ELW	ELW-1S	Abandoned	Abandoned
ELW	ELW-8S	Abandoned	Abandoned
NOP	NOP-04	Abandoned	Abandoned
NOP	NOP-06	Abandoned	Abandoned
NWH	NWH-CL-01	Abandoned	Abandoned
NWH	NWH-CL-02	Abandoned	Abandoned
COS	COS-19	Abandoned	Abandoned
S21	S21-02	Abandoned	Abandoned
STK	STK-01	Abandoned	Abandoned
STK	STK-02	Abandoned	Abandoned
STK	STK-11	Abandoned	Abandoned
STK	STK-13	Abandoned	Abandoned
STK	STK-14	Abandoned	Abandoned
EAG	EAG-Eagles 1	Abandoned	Abandoned
EAG	EAG-Eagles 2	Abandoned	Abandoned

Appendix G: System Model Water Quality Assumptions

Source Well	Level 1 Group	Level 2 Group	Ammonia (mg/L)	Arsenic (mg/L)	Bromide (mg/L)	Chloride (mg/L)	Fluoride (mg/L)	Iron (mg/L)	Nitrate (mg/L)	Nitrite (mg/L)	Ortho P (mg/L)	pH	Sulfate (mg/L)	TDS (mg/L)	(TOC) (mg/L)	Total Sulfide (mg/L)	Turbidity (NTU)	FEEM Reg I (au)	FEEM Reg II (au)	FEEM Reg III (au)	UV254 (cm ⁻¹)	SUVA (L/mg-m)	THMFP (ppb)	Ca Hardness (CaCO ₃)
BUD-2	1-1	1-1	0.51	0.0030	0.04	11.30	0.21	0.07	0.01	0.01	0.02	7.43	125	383	2.2	0.68	0.09	1227	6894	8792	0.048	2.1	142	191
BUD-4	1-2	1-2	0.05	0.0030	0.02	22.30	0.18	0.01	2.33	0.01	0.02	7.40	60	286	0.7	0.01	0.23	186	497	630	0.005	0.7	35	191
BUD-5R	1-3	1-3	0.12	0.0000	0.12	11.36	0.23	0.14	0.05	0.01	0.12	7.33	7	175	1.2	0.01	0.28	676	3525	4456	0.033	1.7	90	191
BUD-6	1-2	1-2	0.05	0.0030	0.07	20.50	0.17	0.01	1.48	0.01	0.02	7.42	54	272	0.5	0.01	0.13	437	560	638	0.006	1.2	15	191
BUD-7	1-4	1-4	0.18	0.0035	0.09	26.60	0.15	0.01	3.08	0.01	0.02	7.42	31	252	0.5	0.01	0.15	199	456	564	0.011	0.7	15	157
CB1	2-9	2-9	0.42	0.0030	0.03	6.87	0.01	0.95	0.01	0.01	0.01	7.00	0	221	2.5	0.04	0.91	1744	7441	9686	0.065	2.1	122	189
CB10	2-2	2-1	0.29	0.0035	0.03	7.06	0.04	0.26	0.04	0.01	0.01	7.31	1	200	2.2	0.03	0.48	899	5102	6641	0.037	1.7	132	189
CB11	2-5	2-5	0.19	0.0035	0.03	6.53	0.06	0.12	0.01	0.01	0.01	7.42	1	191	1.7	0.06	0.09	754	3951	5223	0.028	1.4	92	189
CB12	2-6	2-6	0.09	0.0035	0.02	5.67	0.04	0.28	0.01	0.01	0.02	7.35	1	186	0.9	0.02	0.34	283	1378	1884	0.008	0.7	36	189
CB13	2-5	2-5	0.22	0.0030	0.03	6.23	0.05	0.22	0.06	0.01	0.01	7.36	1	190	1.8	0.03	0.23	732	3895	5126	0.024	1.4	106	189
CB14	2-3	2-3	0.11	0.0035	0.02	5.45	0.05	0.02	0.07	0.01	0.02	7.58	2	187	0.9	0.03	0.14	376	1738	2287	0.010	0.8	49	189
CB15	2-7	2-7	0.17	0.0035	0.03	6.40	0.06	0.03	0.01	0.01	0.01	7.58	3	190	1.6	0.18	0.12	912	4671	5903	0.035	1.8	89	189
CB16	2-4	2-4	0.10	0.0035	0.02	6.20	0.08	0.10	0.39	0.03	0.04	7.44	7	182	1.1	0.04	0.17	484	2795	3622	0.041	1.3	59	189
CB17	2-3	2-3	0.09	0.0035	0.02	5.44	0.06	0.01	0.01	0.01	0.02	7.63	3	187	0.9	0.07	0.09	376	1738	2287	0.010	0.8	42	189
CB2	2-10	2-8	0.38	0.0035	0.03	6.93	0.04	0.59	0.01	0.01	0.01	7.24	0	205	2.5	0.03	0.27	1609	6961	9116	0.047	1.9	154	189
CB3	2-1	2-1	0.47	0.0035	0.02	7.14	0.05	0.27	0.01	0.01	0.01	7.31	0	213	3.0	0.08	0.09	1170	6268	8168	0.042	1.6	184	189
CB4	2-1	2-1	0.37	0.0035	0.03	6.95	0.05	0.33	0.01	0.01	0.01	7.23	0	216	2.7	0.05	0.25	1205	6484	8429	0.043	1.6	166	189
CB5	2-1	2-1	0.32	0.0035	0.03	7.06	0.06	0.30	0.01	0.01	0.01	7.27	0	209	2.4	0.06	0.13	1134	6051	7907	0.226	1.6	145	189
CB6	2-1	2-1	0.33	0.0035	0.03	7.34	0.05	0.30	0.01	0.01	0.01	7.33	0	213	2.5	0.05	0.15	1170	6268	8168	0.042	1.6	153	189
CB7	2-8	2-8	0.40	0.0035	0.03	6.89	0.01	0.43	0.01	0.01	0.01	7.21	0	211	2.6	0.06	0.18	1702	7679	9981	0.077	2.0	145	189
CB8	2-1	2-1	0.38	0.0035	0.03	6.85	0.05	0.41	0.01	0.01	0.06	7.30	0	213	3.0	0.05	0.23	1170	6268	8168	0.042	1.6	184	189
CB9	2-1	2-1	0.36	0.0035	0.07	6.97	0.06	0.38	0.01	0.01	0.01	7.33	0	213	2.8	0.03	0.15	1170	6268	8168	0.042	1.6	170	189
CC1	3-1	3-1	0.20	0.0035	0.04	8.72	0.07	0.05	0.01	0.01	0.02	7.31	3	227	2.5	0.04	0.09	1538	7156	9168	0.074	2.4	172	189
CC10	3-8	3-4	0.13	0.0035	0.04	9.17	0.01	0.10	0.01	0.01	0.01	7.19	27	298	3.8	0.19	0.11	1733	10965	13561	0.085	2.5	210	189
CC11	3-9	3-5	0.17	0.0035	0.04	8.93	0.01	0.08	0.01	0.01	0.02	7.23	18	280	4.8	0.13	0.11	2137	14030	17333	0.162	3.0	290	189
CC12	3-10	3-3	0.12	0.0035	0.04	9.90	0.01	0.09	0.01	0.01	0.01	7.19	24	283	3.9	0.06	0.15	1297	8668	11195	0.082	2.1	242	189
CC13	3-10	3-3	0.14	0.0035	0.03	9.03	0.21	0.08	0.01	0.01	0.01	7.32	27	283	3.0	0.13	0.10	1297	8668	11195	0.082	2.1	184	189
CC2	3-2	3-2	0.18	0.0030	0.03	7.96	0.07	0.02	0.01	0.01	0.02	7.40	6	234	2.4	0.17	0.10	1470	6668	8502	0.057	2.4	147	189
CC3	3-3	3-3	0.21	0.0035	0.04	8.67	0.11	0.06	0.01	0.01	0.01	7.27	21	275	3.0	0.16	0.13	1782	7844	10114	0.067	2.2	185	189
CC4	3-4	3-1	0.13	0.0035	0.06	8.93	0.07	0.02	0.01	0.01	0.02	7.28	26	297	3.6	0.24	0.11	1303	6797	8765	0.069	1.9	223	189
CC5	3-4	3-1	0.14	0.0035	0.04	8.40	0.01	0.02	0.01	0.01	0.02	7.28	25	297	2.8	0.35	0.08	1303	6797	8765	0.069	1.9	173	189
CC6	3-6	3-3	0.20	0.0035	0.04	8.30	0.01	0.02	0.01	0.01	0.04	7.33	11	258	3.0	0.44	0.20	1775	8112	10406	0.069	2.3	156	189
CC7	3-7	3-2	0.22	0.0035	0.07	7.92	0.12	0.02	0.01	0.01	0.03	7.33	19	277	2.8	0.27	0.09	1253	7449	9271	0.057	2.2	170	189
CC8	3-7	3-2	0.11	0.0035	0.03	8.24	0.01	0.05	0.01	0.01	0.02	7.35	38	277	2.1	0.17	0.10	1253	7449	9271	0.057	2.2	128	189
CC9	3-7	3-2	0.10	0.0035	0.04	9.15	0.01	0.04	0.01	0.01	0.01	7.31	28	277	2.5	0.10	0.09	1253	7449	9271	0.057	2.2	155	189

Source Well	Level 1 Group	Level 2 Group	Ammonia (mg/L)	Arsenic (mg/L)	Bromide (mg/L)	Chloride (mg/L)	Fluoride (mg/L)	Iron (mg/L)	Nitrate (mg/L)	Nitrite (mg/L)	Ortho P (mg/L)	pH	Sulfate (mg/L)	TDS (mg/L)	(TOC) (mg/L)	Total Sulfide (mg/L)	Turbidity (NTU)	FEEM Reg I (au)	FEEM Reg II (au)	FEEM Reg III (au)	UV254 (cm ⁻¹)	SUVA (L/mg-m)	THMFP (ppb)	Ca Hardness (CaCO ₃)
CO-1	4-8	4-1	0.52	0.0040	0.05	10.77	0.10	0.01	0.01	0.01	0.07	7.26	2	239	4.0	1.25	0.20	2547	16158	19222	0.123	3.1	249	186
CO-10	4-10	4-5	0.61	0.0035	0.05	12.45	0.11	0.06	0.01	0.01	0.09	7.34	3	189	2.9	0.10	0.10	1699	12145	14414	0.097	3.3	181	186
CO-12A	4-9	4-3	0.63	0.0035	0.06	10.60	0.11	0.14	0.01	0.01	0.08	7.27	0	214	4.0	0.06	0.11	2624	16530	19597	0.129	3.2	250	186
CO-16	4-6	4-2	0.50	0.0035	0.05	13.91	0.09	0.02	0.01	0.01	0.01	7.25	1	240	3.7	0.59	0.17	2499	14834	17654	0.113	2.8	239	186
CO-18	4-8	4-1	0.54	0.0035	0.04	9.07	0.11	0.01	0.01	0.05	0.02	7.31	2	245	4.1	1.32	0.17	2900	18264	21684	0.132	3.2	255	186
CO-20	4-3	4-3	0.58	0.0035	0.02	8.98	0.11	0.01	0.01	0.01	0.03	7.46	1	228	3.9	0.77	0.17	2661	16990	20167	0.127	3.0	245	186
CO-21	4-2	4-2	0.41	0.0040	0.04	9.10	0.09	0.02	0.01	0.01	0.03	7.31	1	189	3.6	0.38	0.11	2243	14132	16828	0.106	2.9	227	186
CO-24	4-9	4-3	0.58	0.0035	0.02	10.87	0.13	0.02	0.01	0.01	0.04	7.32	0	214	4.3	0.19	0.20	2624	16530	19597	0.129	3.2	273	186
CO-25	4-5	4-5	0.61	0.0035	0.10	17.73	0.12	0.06	0.01	0.01	0.06	7.01	1	231	4.1	0.20	0.27	2266	15462	18489	0.130	3.2	268	186
CO-30	4-12	4-5	0.55	0.0035	0.07	9.51	0.15	0.04	0.01	0.01	0.05	7.25	1	239	4.2	0.68	0.23	2862	18381	21603	0.137	3.3	262	186
CO-31	4-7	4-4	0.60	0.0040	0.09	9.48	0.14	0.01	0.01	0.01	0.02	7.32	6	246	4.2	2.38	0.14	3156	19463	23090	0.180	4.1	272	186
CO-32	4-4	4-1	0.42	0.0035	0.09	11.30	0.08	0.07	0.01	0.01	0.07	6.94	8	240	4.6	0.52	0.53	2716	17441	20782	0.136	2.9	286	186
CO-34	4-11	4-1	0.60	0.0035	0.04	8.60	0.15	0.01	0.01	0.01	0.02	7.37	1	261	4.6	1.23	0.49	3438	21853	25883	0.147	3.2	290	186
CO-3A	4-3	4-3	0.46	0.0035	0.03	9.66	0.11	0.01	0.01	0.01	0.02	7.38	2	223	3.9	1.08	0.36	2595	16938	20105	0.119	3.1	242	186
CO-5	4-3	4-3	0.49	0.0035	0.04	9.24	0.12	0.01	0.01	0.01	0.09	7.35	0	232	3.8	0.82	0.15	2728	17043	20229	0.131	3.0	244	186
CO-6A	4-9	4-3	0.54	0.0035	0.02	11.33	0.09	0.08	0.01	0.01	0.07	7.33	0	214	3.9	0.11	0.18	2624	16530	19597	0.129	3.2	241	186
CO-7A	4-1	4-1	0.49	0.0035	0.04	11.40	0.11	0.02	0.01	0.01	0.02	7.32	1	237	5.0	0.76	0.24	3088	19223	22855	0.135	2.7	313	186
CO-8	4-4	4-1	0.52	0.0035	0.05	14.10	0.09	0.03	0.01	0.01	0.08	7.31	3	240	4.6	0.54	0.31	2716	17441	20782	0.136	2.9	330	186
CO-9	4-3	4-3	0.53	0.0035	0.02	10.53	0.12	0.07	0.01	0.01	0.05	7.31	1	228	4.2	0.30	0.18	2661	16990	20167	0.127	3.0	264	186
CRLWD1	5-1	5-1	0.67	0.0035	0.07	29.10	0.06	0.02	0.01	0.01	0.01	7.12	4	276	3.0	0.93	0.09	1526	8872	10994	0.090	3.0	186	182
CRLWD2	5-2	5-1	0.46	0.0035	0.04	10.60	0.09	0.03	0.01	0.01	0.03	7.44	1	222	2.5	0.42	0.12	1402	8287	10142	0.067	2.5	168	182
CRLWD3	5-3	5-1	0.59	0.0035	0.05	20.20	0.07	0.04	0.01	0.01	0.06	7.27	2	243	2.6	0.25	0.10	1338	7097	8775	0.063	2.5	156	182
CY10	6-5	6-3	0.06	0.0035	0.08	9.44	0.01	0.09	0.01	0.01	0.01	7.26	0	231	1.8	0.01	0.10	592	2910	3760	0.024	1.5	104	180
CY11	6-4	6-1	0.06	0.0035	0.05	8.54	0.11	0.08	0.01	0.01	0.05	7.21	1	267	1.9	0.01	0.10	1018	4390	5765	0.031	1.6	116	180
CY2	6-1	6-1	0.10	0.0035	0.02	8.08	0.11	0.14	0.01	0.01	0.08	7.20	1	209	2.0	0.04	0.10	872	4534	5598	0.031	1.9	118	180
CY4	6-1	6-1	0.14	0.0035	0.03	8.10	0.01	0.12	0.01	0.01	0.02	7.35	1	209	1.5	0.02	0.09	872	4534	5598	0.031	1.9	98	180
CY5	6-1	6-1	0.15	0.0035	0.02	7.22	0.14	0.12	0.01	0.01	0.05	7.35	0	209	1.9	0.01	0.10	872	4534	5598	0.031	1.9	112	180
CY6	6-5	6-3	0.11	0.0035	0.03	9.67	0.11	0.07	0.01	0.01	0.04	7.32	1	231	1.3	0.01	0.07	592	2910	3760	0.024	1.5	79	180
CY7	6-5	6-3	0.21	0.0035	0.02	8.67	0.10	0.07	0.01	0.01	0.01	7.38	0	231	1.5	0.01	0.11	592	2910	3760	0.024	1.5	90	180
CY8	6-2	6-2	0.16	0.0035	0.05	7.00	0.13	0.03	0.01	0.01	0.02	7.48	1	221	1.9	0.03	0.08	1371	7089	8649	0.045	2.4	113	180
CY9	6-3	6-1	0.13	0.0040	0.05	9.07	0.12	0.08	0.01	0.01	0.02	7.61	0	244	2.0	0.01	0.11	1260	5406	6711	0.039	2.0	119	180
ELW101	7-2	7-1	0.46	0.0035	0.04	12.98	0.12	0.09	0.01	0.01	0.06	7.30	3	258	4.0	0.43	0.26	2098	12644	15473	0.100	2.5	249	187
ELW102	7-3	7-3	0.44	0.0030	0.08	8.68	0.12	0.02	0.01	0.01	0.02	7.29	1	264	5.4	1.09	0.24	2533	16706	20282	0.141	2.6	343	187
ELW103	7-4	7-1	0.43	0.0035	0.04	10.70	0.11	0.01	0.01	0.01	0.04	7.38	4	236	4.2	1.21	0.15	2431	12908	15674	0.103	2.5	261	187
ELW104	7-5	7-1	0.30	0.0035	0.05	8.58	0.12	0.01	0.01	0.01	0.12	7.28	3	253	4.5	1.02	0.19	2403	13678	16546	0.103	2.5	279	187
ELW105	7-1	7-1	0.39	0.0035	0.04	10.35	0.10	0.02	0.01	0.06	0.05	7.41	4	306	3.9	1.06	0.14	2286	13125	15924	0.098	2.5	242	187
ELW106	7-5	7-1	0.34	0.0035	0.04	12.85	0.08	0.01	0.01	0.01	0.02	7.35	4	255	4.2	0.99	0.19	2352	13680	16590	0.107	2.5	264	187
ELW107	7-5	7-1	0.36	0.0035	0.04	10.26	0.10	0.01	0.01	0.01	0.01	7.38	3	251	3.8	0.98	0.18	2454	13675	16502	0.101	2.5	259	187

Source Well	Level 1 Group	Level 2 Group	Ammonia (mg/L)	Arsenic (mg/L)	Bromide (mg/L)	Chloride (mg/L)	Fluoride (mg/L)	Iron (mg/L)	Nitrate (mg/L)	Nitrite (mg/L)	Ortho P (mg/L)	pH	Sulfate (mg/L)	TDS (mg/L)	(TOC) (mg/L)	Total Sulfide (mg/L)	Turbidity (NTU)	FEEM Reg I (au)	FEEM Reg II (au)	FEEM Reg III (au)	UV254 (cm ⁻¹)	SUVA (L/mg-m)	THMFP (ppb)	Ca Hardness (CaCO ₃)
ELW109	7-6	7-6	0.37	0.0045	0.04	8.81	0.12	0.02	0.01	0.01	0.04	7.39	1	235	4.0	1.20	0.36	2520	14898	18036	0.123	3.0	247	187
ELW10A	7-19	7-4	0.47	0.0035	0.09	9.05	0.13	0.03	0.01	0.01	0.04	7.46	5	214	3.5	0.93	0.21	2266	14833	17743	0.119	3.3	267	187
ELW110	7-6	7-6	0.47	0.0035	0.04	9.15	0.01	0.01	0.01	0.01	0.03	7.38	1	235	4.0	0.86	0.21	2520	14898	18036	0.123	3.0	252	187
ELW112	7-7	7-3	0.75	0.0035	0.07	8.80	0.12	0.01	0.01	0.01	0.05	7.33	1	210	5.2	0.80	0.22	2800	18365	22022	0.155	3.0	330	187
ELW113	7-8	7-6	0.37	0.0035	0.04	8.82	0.01	0.01	0.01	0.01	0.06	7.38	0	242	4.0	0.91	0.32	2681	15564	18728	0.084	3.0	235	187
ELW114	7-9	7-6	0.47	0.0040	0.06	9.20	0.13	0.01	0.01	0.01	0.08	7.41	3	222	4.3	0.91	0.36	2410	16606	19894	0.143	3.3	272	187
ELW116	7-10	7-7	0.70	0.0035	0.10	12.11	0.08	0.01	0.01	0.01	0.04	7.23	8	220	4.1	1.13	0.19	2347	16168	19750	0.121	3.3	230	187
ELW120	7-11	7-6	0.54	0.0035	0.05	8.43	0.13	0.01	0.01	0.01	0.03	7.48	1	206	3.8	0.82	0.20	2427	15889	18818	0.119	3.2	235	187
ELW121	7-12	7-8	0.49	0.0035	0.07	9.94	0.16	0.02	0.01	0.01	0.04	7.61	10	252	2.6	0.54	0.16	2340	13527	16513	0.110	2.6	171	187
ELW122	7-11	7-6	0.51	0.0035	0.07	8.84	0.13	0.01	0.01	0.01	0.04	7.51	3	206	3.7	0.70	0.16	2427	15889	18818	0.119	3.2	229	187
ELW13	7-20	7-5	0.67	0.0035	0.08	9.14	0.13	0.01	0.01	0.01	0.01	7.48	4	238	4.0	1.45	0.10	2636	17296	20552	0.145	3.4	270	187
ELW131	7-12	7-9	0.35	0.0030	0.04	12.78	0.12	0.01	0.01	0.01	0.03	7.36	3	252	3.8	1.15	0.15	2340	13527	16513	0.101	2.6	226	187
ELW134	7-12	7-10	0.41	0.0033	0.09	23.80	0.12	0.03	0.01	0.01	0.06	7.23	7	252	3.7	0.72	0.23	2340	13527	16513	0.130	2.6	222	187
ELW135	7-13	7-11	0.44	0.0035	0.09	10.20	0.13	0.04	0.01	0.01	0.04	7.20	1	260	4.9	0.82	0.12	2849	16672	20375	0.140	2.6	250	187
ELW136	7-13	7-12	0.46	0.0035	0.05	10.81	0.11	0.06	0.01	0.01	0.07	7.31	2	260	4.5	0.74	0.29	2849	16672	20375	0.119	2.6	269	187
ELW137	7-14	7-6	0.49	0.0035	0.04	9.37	0.01	0.01	0.01	0.01	0.05	7.39	2	217	4.3	1.10	0.19	2510	14783	17917	0.121	2.8	268	187
ELW139	7-15	7-6	0.69	0.0035	0.05	9.11	0.12	0.01	0.01	0.01	0.05	7.38	2	213	4.1	0.86	0.19	2514	15926	19135	0.125	3.0	257	187
ELW140	7-16	7-3	0.53	0.0035	0.04	11.70	0.12	0.01	0.01	0.01	0.04	7.24	1	269	4.8	0.80	0.52	2533	15366	18707	0.129	2.7	302	187
ELW141	7-16	7-3	0.45	0.0035	0.04	10.10	0.12	0.02	0.01	0.01	0.01	7.31	1	256	4.9	0.95	0.15	2562	15991	19352	0.137	2.8	305	187
ELW142	7-17	7-3	0.45	0.0035	0.06	17.20	0.11	0.04	0.01	0.01	0.05	7.15	2	296	4.9	0.33	0.13	2601	15804	19373	0.141	2.7	336	187
ELW9	7-18	7-2	0.50	0.0035	0.09	8.26	0.13	0.01	0.01	0.01	0.11	7.45	3	237	4.2	1.18	0.26	2615	17221	20671	0.156	3.6	319	187
MB150	8-3	8-3	0.20	0.0040	0.02	10.90	0.08	0.16	0.01	0.01	0.07	7.13	1	294	4.6	0.05	0.15	1667	7848	10061	0.067	1.8	288	226
MB151	8-3	8-3	0.13	0.0035	0.08	10.45	0.13	0.09	0.01	0.01	0.06	7.21	0	294	3.7	0.03	0.11	1667	7848	10061	0.067	1.8	157	226
MB152	8-1	8-1	0.12	0.0040	0.05	8.99	0.10	0.19	0.01	0.01	0.11	7.19	0	292	4.0	0.03	0.35	1784	9329	11610	0.082	2.0	251	226
MB153	8-2	8-2	0.16	0.0035	0.05	9.24	0.11	0.08	0.01	0.01	0.03	7.21	0	291	4.6	0.22	0.10	1772	8787	11291	0.076	1.7	291	226
MB154	8-4	8-2	0.41	0.0040	0.05	8.66	0.10	0.27	0.01	0.01	0.04	7.13	0	278	5.2	0.06	0.17	1740	9872	12607	0.090	1.7	327	226
MB155	8-5	8-2	0.16	0.0035	0.06	12.00	0.09	0.44	0.01	0.01	0.07	7.06	0	282	5.3	0.04	0.11	1863	11541	14468	0.107	2.0	337	226
MB156	8-6	8-4	0.13	0.0035	0.04	8.90	0.09	0.03	0.01	0.01	0.08	7.19	0	277	3.4	0.10	0.10	1439	8044	10335	0.073	1.8	208	226
MB157	8-7	8-2	0.21	0.0030	0.08	9.72	0.11	0.25	0.01	0.01	0.05	7.17	1	296	4.1	0.25	0.51	1613	9142	11680	0.092	1.9	244	226
MB158	8-8	8-5	0.23	0.0040	0.08	8.75	0.12	0.02	0.01	0.01	0.01	7.26	3	296	2.5	0.07	0.12	958	4936	6394	0.052	1.5	114	226
MB159	8-9	8-6	0.25	0.0035	0.05	9.71	0.11	0.04	0.01	0.01	0.07	7.19	0	306	4.4	0.15	0.09	1751	8730	11225	0.078	1.8	277	226
MB160	8-9	8-6	0.25	0.0035	0.02	9.76	0.11	0.03	0.01	0.01	0.01	7.10	0	306	4.4	0.31	0.16	1751	8730	11225	0.078	1.8	276	226
MB161	8-10	8-7	0.24	0.0035	0.02	9.87	0.10	0.03	0.01	0.01	0.01	7.22	49	300	3.3	0.83	0.18	1473	7810	10045	0.065	1.97	205	226
MB162	8-11	8-8	0.13	0.0035	0.04	9.36	0.13	0.03	0.01	0.01	0.01	7.23	4	296	3.6	1.03	0.15	1473	7810	10045	0.065	1.8	221	226
MB163	8-11	8-8	0.19	0.0035	0.02	9.35	0.01	0.06	0.01	0.01	0.01	7.23	34	296	3.2	0.77	0.12	1473	7810	10045	0.065	1.8	198	226
MB164	8-12	8-9	0.12	0.0030	0.08	9.17	0.08	0.04	0.01	0.01	0.05	7.22	16	293	3.1	0.72	0.10	1383	6955	8800	0.059	1.9	190	226
MB165	8-12	8-9	0.20	0.0035	0.02	8.32	0.10	0.16	0.01	0.01	0.03	7.23	12	293	3.2	0.63	0.11	1383	6955	8800	0.059	1.9	199	226
MB166	8-13	8-10	0.14	0.0035	0.08	8.65	0.12	0.02	0.01	0.01	0.05	7.25	9	299	2.1	0.32	0.12	1226	6668	8459	0.052	2.5	128	226

Source Well	Level 1 Group	Level 2 Group	Ammonia (mg/L)	Arsenic (mg/L)	Bromide (mg/L)	Chloride (mg/L)	Fluoride (mg/L)	Iron (mg/L)	Nitrate (mg/L)	Nitrite (mg/L)	Ortho P (mg/L)	pH	Sulfate (mg/L)	TDS (mg/L)	(TOC) (mg/L)	Total Sulfide (mg/L)	Turbidity (NTU)	FEEM Reg I (au)	FEEM Reg II (au)	FEEM Reg III (au)	UV254 (cm ⁻¹)	SUVA (L/mg-m)	THMFP (ppb)	Ca Hardness (CaCO ₃)
MB167	8-14	8-11	0.13	0.0035	0.08	9.51	0.13	0.01	0.01	0.01	0.07	7.23	10	300	3.1	0.32	0.10	1084	6238	7985	0.055	1.8	194	226
MB168	8-14	8-11	0.16	0.0040	0.08	8.93	0.13	0.02	0.02	0.01	0.03	7.30	3	300	3.0	0.25	0.10	1084	6238	7985	0.055	1.8	183	226
NWH1	9-1	9-1	0.38	0.0030	0.09	11.50	0.13	0.02	0.01	0.01	0.08	7.39	1	257	3.0	1.03	0.18	2007	12213	14576	0.092	3.0	190	182
NWH2	9-2	9-2	0.41	0.0030	0.05	8.69	0.12	0.01	0.02	0.01	0.05	7.32	1	214	3.2	0.65	0.14	2080	12938	15336	0.105	2.7	195	182
NWH3	9-3	9-3	0.52	0.0035	0.08	10.10	0.12	0.02	0.01	0.01	0.01	7.38	0	239	3.2	0.24	0.29	1959	12318	14749	0.101	2.8	198	182
NWH4	9-3	9-3	0.68	0.0035	0.08	11.10	0.13	0.04	0.01	0.01	0.02	7.39	0	241	4.3	0.08	0.11	2212	13481	16179	0.101	2.3	270	182
NWH5	9-4	9-4	0.45	0.0035	0.04	10.40	0.12	0.02	0.01	0.01	0.02	7.37	1	252	3.1	1.01	0.13	2133	12655	15208	0.095	3.1	189	182
NWH6	9-5	9-5	0.39	0.0035	0.07	20.00	0.12	0.05	0.01	0.01	0.06	7.21	2	280	2.9	0.32	0.11	1792	10769	12922	0.107	2.8	190	182
NWH7	10-1	10-1	0.45	0.0030	0.02	9.64	0.10	0.06	0.18	0.18	0.04	7.38	0	260	3.6	0.03	0.18	2768	15295	18707	0.113	3.1	224	184
S-21-#10	10-4	10-1	0.62	0.0035	0.04	10.90	0.07	0.07	0.01	0.01	0.01	7.27	0	246	4.0	0.12	0.16	2137	13744	16701	0.116	2.9	252	184
S-21-#5	10-2	10-2	0.50	0.0030	0.02	7.17	0.05	0.07	0.18	0.18	0.01	7.49	0	210	2.9	0.02	0.12	2134	13382	16162	0.100	3.5	172	184
S-21-#6	10-2	10-2	0.50	0.0030	0.02	7.54	0.08	0.10	0.03	0.01	0.02	7.44	0	210	3.3	0.30	2.06	2134	13382	16162	0.100	3.5	206	184
S-21-#8	10-3	10-1	0.49	0.0030	0.04	11.10	0.07	0.08	0.01	0.01	0.03	7.33	0	215	3.7	0.10	0.18	2185	14151	16856	0.123	3.1	266	184
S-21-#9	10-3	10-1	0.60	0.0035	0.02	10.66	0.07	0.08	0.01	0.01	0.01	7.40	0	215	3.9	0.08	0.30	2185	14151	16856	0.123	3.1	241	184
SCH1	11-1	11-1	0.35	0.0035	0.05	12.50	0.57	0.01	0.01	0.01	0.02	7.45	113	342	1.4	1.10	0.11	1521	5116	6359	0.037	2.7	79	142
SCH10	11-6	11-2	0.29	0.0035	0.10	13.23	0.39	0.01	0.01	0.01	0.02	7.49	15	224	1.8	0.81	0.11	1364	5953	7404	0.037	2.1	104	142
SCH11	11-7	11-7	0.39	0.0035	0.08	12.53	0.35	0.01	0.01	0.01	0.01	7.57	38	248	1.8	2.28	0.17	1151	5515	6987	0.053	2.6	104	142
SCH12	11-7	11-7	0.37	0.0035	0.08	12.23	0.34	0.02	0.01	0.01	0.02	7.59	27	248	1.7	2.31	0.15	1151	5515	6987	0.053	2.6	100	142
SCH13	11-7	11-7	0.43	0.0035	0.08	12.33	0.35	0.01	0.01	0.01	0.02	7.53	50	249	1.5	2.60	0.12	1193	6103	7679	0.070	2.7	102	142
SCH14	11-8	11-8	0.40	0.0035	0.05	12.10	0.39	0.01	0.01	0.02	0.02	7.47	113	341	1.4	1.95	0.19	1386	5105	6425	0.056	3.2	82	142
SCH15	11-7	11-7	0.36	0.0035	0.08	12.13	0.36	0.01	0.01	0.02	0.02	7.54	39	228	1.6	2.48	0.13	1238	5475	6891	0.037	2.4	91	142
SCH16	11-9	11-9	0.35	0.0035	0.02	11.56	0.35	0.06	0.01	0.01	0.02	7.63	21	307	1.6	2.10	0.42	1130	5221	6641	0.035	2.2	93	142
SCH17	11-7	11-7	0.44	0.0035	0.08	11.45	0.40	0.01	0.01	0.01	0.02	7.59	73	268	1.5	2.38	0.19	1021	4968	6392	0.032	2.6	88	142
SCH2	11-2	11-2	0.34	0.0035	0.07	13.50	0.52	0.01	0.02	0.01	0.02	7.49	87	309	1.6	1.04	0.11	1170	5509	6978	0.031	1.9	96	142
SCH3	11-3	11-2	0.40	0.0035	0.07	13.19	0.45	0.01	0.01	0.01	0.02	7.51	111	378	1.4	1.51	0.13	1246	5710	7184	0.034	2.2	83	142
SCH4	11-3	11-2	0.39	0.0035	0.07	12.71	0.44	0.04	0.01	0.01	0.02	7.43	133	378	1.5	1.58	0.15	1246	5710	7184	0.034	2.2	87	142
SCH5	11-4	11-2	0.41	0.0035	0.07	14.19	0.38	0.03	0.01	0.01	0.02	7.44	91	323	1.6	1.96	0.25	1366	6463	8208	0.036	2.0	85	142
SCH6	11-4	11-2	0.36	0.0035	0.07	13.88	0.36	0.11	0.01	0.01	0.02	7.51	77	323	1.6	1.95	0.14	1366	6463	8208	0.036	2.0	96	142
SCH7	11-5	11-1	0.32	0.0035	0.06	13.24	0.35	0.02	0.01	0.01	0.02	7.47	37	256	1.6	1.57	0.32	1240	6267	7892	0.060	2.5	80	142
SCH8	11-10	11-2	0.35	0.0035	0.06	13.80	0.36	0.01	0.01	0.01	0.02	7.47	31	236	1.6	1.17	0.11	1343	6009	7515	0.034	2.1	94	142
SCH9	11-6	11-2	0.32	0.0035	0.10	13.63	0.37	0.01	0.01	0.01	0.01	7.55	28	224	1.7	1.05	0.13	1364	5953	7404	0.037	2.1	98	142
SP-41	12-1	12-1	0.71	0.0035	0.02	8.72	0.06	0.04	0.01	0.01	0.01	7.41	0	245	4.6	0.13	0.20	2696	16343	19840	0.135	2.9	287	184
SP-43	12-2	12-1	0.70	0.0035	0.05	7.65	0.07	0.01	0.01	0.01	0.01	7.46	0	249	4.1	0.18	0.12	2737	14640	17663	0.119	2.9	257	184
SP-44	12-2	12-1	0.73	0.0035	0.02	7.24	0.05	0.02	0.01	0.01	0.01	7.42	0	249	3.7	0.11	0.18	2737	14640	17663	0.119	2.9	230	184
SP-46	12-1	12-1	0.78	0.0035	0.05	8.56	0.08	0.01	0.01	0.01	0.01	7.44	0	245	4.7	0.27	0.21	2696	16343	19840	0.135	2.9	298	184
SP-47	12-3	12-3	0.65	0.0035	0.05	7.85	0.08	0.01	0.01	0.01	0.01	7.46	0	230	4.7	0.55	0.14	2409	14063	17014	0.113	2.9	295	184
SP-48	12-3	12-3	0.63	0.0035	0.05	8.06	0.08	0.01	0.03	0.01	0.02	7.41	1	230	4.3	0.74	0.18	2409	14063	17014	0.113	2.9	270	184
SP-49	12-3	12-3	0.63	0.0035	0.05	7.96	0.07	0.02	0.01	0.01	0.04	7.41	0	230	3.9	0.22	0.24	2409	14063	17014	0.113	2.9	264	184

Source Well	Level 1 Group	Level 2 Group	Ammonia (mg/L)	Arsenic (mg/L)	Bromide (mg/L)	Chloride (mg/L)	Fluoride (mg/L)	Iron (mg/L)	Nitrate (mg/L)	Nitrite (mg/L)	Ortho P (mg/L)	pH	Sulfate (mg/L)	TDS (mg/L)	(TOC) (mg/L)	Total Sulfide (mg/L)	Turbidity (NTU)	FEEM Reg I (au)	FEEM Reg II (au)	FEEM Reg III (au)	UV254 (cm ⁻¹)	SUVA (L/mg-m)	THMFP (ppb)	Ca Hardness (CaCO ₃)
SP-50	12-4	12-1	0.61	0.0040	0.02	8.20	0.06	0.02	0.01	0.01	0.14	7.31	1	231	4.6	0.35	0.35	2475	14498	17863	0.123	2.8	317	184
ST10	13-4	13-4	0.38	0.0035	0.04	8.29	0.10	0.02	0.01	0.01	0.01	7.37	3	269	4.3	0.46	0.18	3169	18335	21615	0.136	2.8	248	195
ST3	13-1	13-1	0.46	0.0035	0.02	9.29	0.10	0.01	0.01	0.01	0.03	7.51	4	182	3.1	1.20	0.15	1710	10325	12762	0.097	3.2	188	195
ST4	13-6	13-4	0.33	0.0035	0.08	8.64	0.16	0.04	0.01	0.01	0.06	7.15	8	267	4.8	1.38	0.11	2213	13624	16511	0.120	2.5	300	195
ST6	13-3	13-3	0.33	0.0035	0.02	8.18	0.16	0.10	0.01	0.01	0.06	7.26	4	267	4.3	0.49	0.24	2460	14841	17728	0.129	2.8	284	195
ST7	13-7	13-4	0.37	0.0035	0.08	10.10	0.15	0.04	0.01	0.01	0.09	7.17	6	267	5.0	1.34	0.19	2863	17205	20709	0.156	3.1	315	195
ST8	13-4	13-4	0.40	0.0035	0.08	8.50	0.13	0.02	0.01	0.01	0.01	7.25	2	267	5.4	0.60	0.14	2689	16513	19708	0.127	2.4	338	195
ST9	13-5	13-5	0.33	0.0035	0.09	9.90	0.17	0.08	0.01	0.01	0.03	7.22	19	301	4.5	2.61	0.19	2910	18065	21666	0.146	3.8	253	195
DESALEFF			0.07	0.0026	0.28	81.39	0.01	0.02	0.01	0.01	0.01	8.04	3	217	0.1	0.01	0.37				0.005	2.17	4	45
RSWTPEFF			0.05	0.0020	0.07	30.14	0.29	0.01	0.32	0.01	0.01	7.90	183	391	2.0	0.01	0.11				0.022	1.12	158	211

Appendix H: Water Supply Contract

MASTER WATER SUPPLY CONTRACT

among

WEST COAST REGIONAL WATER SUPPLY AUTHORITY,

and

HILLSBOROUGH COUNTY, FLORIDA

and

CITY OF NEW PORT RICHEY, FLORIDA

and

PASCO COUNTY, FLORIDA

and

PINELLAS COUNTY, FLORIDA

and

CITY OF ST. PETERSBURG, FLORIDA

and

CITY OF TAMPA, FLORIDA

Dated as of May 1, 1998

TABLE OF CONTENTS

	<u>Page</u>
SECTION 1.	RECITALS..... 3
SECTION 2.	EXHIBITS..... 3
SECTION 3.	DEFINITIONS..... 5
SECTION 4.	TERM..... 14
SECTION 5.	CONDITIONS PRECEDENT..... 14
SECTION 6.	SATISFACTION OF THE CONDITIONS PRECEDENT..... 15
SECTION 7.	REPRESENTATIONS OF THE PARTIES..... 15
SECTION 8.	AUTHORITY'S AGREEMENT TO PROVIDE WATER SERVICE..... 17
SECTION 9.	MEMBER GOVERNMENTS' WATER SERVICE..... 19
SECTION 10.	POINTS OF CONNECTION AND METER LOCATIONS..... 20
SECTION 11.	METERING FACILITIES..... 22
SECTION 12.	ANNUAL REPORT..... 23
SECTION 13.	RATE..... 24
SECTION 14.	PLEDGE OF CONTRACT REVENUES..... 29
SECTION 15.	DEVELOPMENT OF NEW WATER SUPPLY SOURCES..... 30
SECTION 16.	MEMBER GOVERNMENTS' RIGHTS TO DEVELOP AND SUPPLY WATER..... 30
SECTION 17.	ADDITIONAL REPRESENTATIONS, WARRANTIES AND COVENANTS OF THE AUTHORITY..... 30
SECTION 18.	ADDITIONAL REPRESENTATIONS, WARRANTIES AND COVENANTS OF THE MEMBER GOVERNMENTS..... 32
SECTION 19.	ARBITRATION..... 35
SECTION 20.	AUTHORITY'S SOURCES OF WATER..... 39
SECTION 21.	DEFAULT AND REMEDY..... 39
SECTION 22.	DISPOSITION OF ASSETS UPON TERMINATION OF AUTHORITY..... 43
SECTION 23.	APPLICABLE LAW AND VENUE..... 43
SECTION 24.	ASSIGNMENT..... 43
SECTION 25.	NOTICES..... 43
SECTION 26.	THIRD-PARTY BENEFICIARIES..... 45
SECTION 27.	WAIVER..... 45
SECTION 28.	CAPTIONS AND REFERENCES..... 46
SECTION 29.	SEVERABILITY..... 46
SECTION 30.	AMENDMENT..... 46
SECTION 31.	NO OTHER AGREEMENTS..... 46
SECTION 32.	EXISTING AGREEMENTS..... 46
SECTION 33.	SUCCESSORS AND ASSIGNS..... 47
SECTION 34.	EXECUTION OF DOCUMENTS..... 47
SECTION 35.	INTERLOCAL AGREEMENT..... 47

SECTION 36.	OBLIGATIONS OF MEMBER GOVERNMENTS.....	47
SECTION 37.	CONFLICT WITH INTERLOCAL AGREEMENT.....	48
SECTION 38.	GOOD FAITH.....	48
SECTION 39.	MISCELLANEOUS PROVISIONS.....	48

EXHIBIT A	AUTHORITY'S SYSTEM
EXHIBIT B	MASTER WATER PLAN
EXHIBIT C	POINTS OF CONNECTION
EXHIBIT D	SUPPLEMENTAL WATER QUALITY PARAMETERS
EXHIBIT E	DESCRIPTION OF WATER SERVICE AREAS
EXHIBIT F	RATES
EXHIBIT G	TERMINATED AGREEMENTS
EXHIBIT H	SURVIVING AGREEMENTS
EXHIBIT I	MODIFIED AGREEMENTS
EXHIBIT J	SUPERSEDED AGREEMENTS
EXHIBIT K	FORM OF ANNUAL REPORT
EXHIBIT L	ARBITRATION DISCOVERY RULES

MASTER WATER SUPPLY CONTRACT

THIS MASTER WATER SUPPLY CONTRACT (the "Contract"), entered into as of this 1st day of May, 1998, by and among the **WEST COAST REGIONAL WATER SUPPLY AUTHORITY**, an interlocal governmental agency created and existing pursuant to Sections 373.1962 and 163.01, Florida Statutes (the "Authority"), as reorganized by that certain Amended and Restated Interlocal Agreement, dated as of May 1, 1998 (the "Interlocal Agreement"); **HILLSBOROUGH COUNTY, FLORIDA**, a political subdivision of the State of Florida ("Hillsborough"); the **CITY OF NEW PORT RICHEY, FLORIDA**, a municipal corporation of the State of Florida ("New Port Richey"); **PASCO COUNTY, FLORIDA**, a political subdivision of the State of Florida ("Pasco"); **PINELLAS COUNTY, FLORIDA**, a political subdivision of the State of Florida ("Pinellas"); the **CITY OF ST. PETERSBURG, FLORIDA**, a municipal corporation of the State of Florida ("St. Petersburg") and the **CITY OF TAMPA, FLORIDA**, a municipal corporation of the State of Florida ("Tampa") (Hillsborough, New Port Richey, Pasco, Pinellas, St. Petersburg and Tampa may sometimes be collectively referred to herein as the "Member Governments" and individually referred to as a "Member Government").

WHEREAS, the Authority was created by Hillsborough, Pasco, Pinellas, St. Petersburg and Tampa on October 25, 1974, as amended, for the purpose of developing, recovering, storing and supplying water for county and municipal purposes in such manner as will give priority to reducing the adverse environmental effects of excessive or improper withdrawals from concentrated areas; and

WHEREAS, as of May 1, 1998, the Member Governments reorganized the Authority pursuant to the Interlocal Agreement in order to establish the Authority as a water utility; and

WHEREAS, the Authority and the Member Governments currently own or lease, control and manage various water production, treatment and transmission facilities for the supply of water to customers of the Member Governments; and

WHEREAS, the Member Governments have heretofore determined that the Authority shall own, license or lease and operate various water production, treatment and transmission facilities (collectively, the "System"), including certain facilities currently owned, licensed or leased by Member Governments, for the common use and benefit of the Member Governments, in the manner specified in the Interlocal Agreement; and

WHEREAS, on the Effective Date (as defined herein) of this Contract the Member Governments shall have certain water needs; and

WHEREAS, the Authority agrees that it shall satisfy the aforementioned water needs of the Member Governments in accordance with the terms hereof; and

WHEREAS, the Member Governments desire the Authority to expand the System to meet the common needs of all of the Member Governments, in the manner specified herein and in the Interlocal Agreement; and

WHEREAS, the Member Governments desire to share the costs of operating, developing, acquiring, constructing, equipping and expanding the Authority's System in the manner specified herein and in the Interlocal Agreement; and

WHEREAS, the Member Governments desire to purchase and the Authority desires to sell water produced by the Authority from the System at a rate, as specified herein; and

WHEREAS, the Member Governments agree that this Contract shall supersede and replace various existing agreements described herein between the Authority and each of the Member Governments relating to supplying water upon issuance of the herein-described Series 1998 Bonds by the Authority; and

WHEREAS, such Series 1998 Bonds shall be secured in the manner provided herein and pursuant to the instrument by which they shall be issued; and

WHEREAS, the proceeds of the Series 1998 Bonds shall be used principally (1) to restructure the Authority's outstanding debt so that the terms hereof shall pertain to all water supplied by the Authority to the Member Governments, (2) to fund certain capital improvements to the System, and (3) to acquire certain Transferred Assets (as defined herein) from Member Governments;

NOW, THEREFORE, for and in consideration of the above premises, which shall be deemed an integral part of this Contract, and of the mutual covenants and agreements hereafter set forth, the Authority, Hillsborough, New Port Richey, Pasco, Pinellas, St. Petersburg and Tampa, intending to be legally bound, hereby agree as follows:

SECTION 1. RECITALS. The foregoing recitals are true and correct and are incorporated by reference herein and made a part hereof.

SECTION 2. EXHIBITS. Except as otherwise expressly provided herein, all Exhibits identified herein are made a part hereof and are incorporated herein by this

reference to the same extent as if fully set forth herein. Exhibits A and F may be amended or supplemented from time to time by the Authority in accordance with the terms hereof without approval by any Member Government. Exhibit B shall not be amended to reflect any change or modification to the Master Water Plan as the same may be made from time to time. Exhibit B is attached hereto for informational purposes only. Amendments to Exhibit C shall require the written consent of the Authority and any affected Member Government. For purposes of Exhibit C, a Member Government shall be considered affected if the amendment or supplement thereto directly affects the point or location at which such Member Government receives Quality Water from the Authority. The standards for the arbitration process provided in Exhibit D may only be changed with the consent of the Authority and all Member Governments. Specific water quality parameters in Exhibit D may be changed by the Authority without consent of the Member Governments, subsequent to arbitration by any Member Government as provided in Exhibit D; provided, however, the Authority agrees to comply with the results of any arbitration determinations relating to Water quality standards. Exhibit E may only be amended or supplemented by the Member Government which is modifying its Water Service Area, provided Authority approval shall be required under the circumstances described in the last sentence of Section 9 hereof. Exhibits G, H, I and J shall not be amended without the written consent of all parties hereto. Exhibit K is attached hereto for informational purposes only. No Exhibit hereto may be amended or supplemented in contravention to the terms of this Contract. All Exhibits shall be construed amended or supplemented upon delivery of a new Exhibit by the Authority to each Member

Government, with written consent where appropriate as described above. No amendment or supplement to the Exhibits hereto shall require the reexecution of this Contract.

SECTION 3. DEFINITIONS. Unless otherwise specifically set forth elsewhere in this Contract, the following words and phrases used in this Contract shall have the following meanings:

(A) **"Annual Estimate"** shall mean the estimate of the Authority Costs for a Fiscal Year, including the estimated amount thereof to be payable by each Member Government, and submitted to each Member Government on an annual basis, as required by Section 13 hereof. The Annual Estimate shall be based upon the Authority's proposed annual budget and estimated rate and shall consider the Annual Reports in determining the estimated amounts to be payable by the Member Governments.

(B) **"Annual Report"** or **"Annual Reports"** shall mean the report setting forth the next five (5) Fiscal Years of anticipated Water Service within the Water Service Areas for each of the Member Governments to be prepared by each such Member Government and submitted to the Authority as required by Section 12 hereof. The Annual Report may be amended by the Member Governments from time to time. The Annual Report shall be substantially in the form provided in Exhibit K hereto.

(C) **"Authority"** shall mean the West Coast Regional Water Supply Authority, an interlocal governmental agency created on October 25, 1974, and existing pursuant to Sections 373.1962 and 163.01, Florida Statutes, and pursuant to an interlocal agreement, among Hillsborough, Pasco, Pinellas, St. Petersburg and Tampa dated October 25, 1974, as amended, supplemented and reorganized pursuant to the Interlocal Agreement.

(D) **"Authority Costs"** shall mean Bond Coverage Costs, Capital Improvement Charges, Debt Service Charges, Operation, Maintenance and Administrative Costs, Operating Reserve Funds and Renewal and Replacement Charges.

(E) **"Authority's System"** or **"System"** shall mean the Authority's water production, transmission and treatment facilities, as they currently exist and as they may be modified or expanded in the future from time to time, which are owned, leased, licensed, operated and/or used by the Authority to provide Water. On the Effective Date hereof, the System shall consist of the facilities described in Exhibit A attached hereto. Such Exhibit A shall be amended or supplemented from time to time by the Authority to reflect any changes or modifications to such System.

(F) **"Bond Coverage Costs"** shall mean the costs of providing the coverage requirements established by the Financing Documents.

(G) **"Capital Improvement Charge"** shall mean the costs identified by the Authority for planning, designing, acquiring and constructing capital improvements to the System; provided such costs are not payable from proceeds of the Obligations (other than costs which are to be reimbursed from such proceeds) or from moneys received in relation to the Renewal and Replacement Charges.

(H) **"Debt Service Charges"** shall mean the principal, redemption premium, if any, and interest coming due on the Obligations and any recurring costs and expenses relating to the Obligations, including, but not limited to, paying agent, registrar and escrow agent fees, credit enhancement fees and other charges, but only to the extent such costs

and expenses are not otherwise reflected in Operation, Maintenance and Administrative Costs.

(I) **"DEP"** shall mean the Florida Department of Environmental Protection, a department and agency of the State of Florida, and any successor thereto.

(J) **"Effective Date"** shall mean the date on which all conditions precedent described in Section 5 hereof have been satisfied.

(K) **"Environmental Permits"** shall mean all permits, licenses or other third-party approvals necessary for the acquisition, construction or operation of an Authority Water Supply Facility, including, but not limited to, Primary Environmental Permits.

(L) **"Existing Authority System"** shall have the meaning provided therefor in the Interlocal Agreement.

(M) **"Financing Documents"** shall mean any resolution or resolutions of the Authority, as well as any indenture of trust, trust agreement or similar document relating to the issuance or security of the Obligations.

(N) **"Fiscal Year"** shall mean a twelve (12) month period which commences on October 1 of each year and ends on the next succeeding September 30, or such other period as may be prescribed by law as the fiscal year for the Authority.

(O) **"Fixed Costs"** shall mean all costs and expenses incurred by the Authority for the operation, maintenance, management, security, development and financing of the System other than Variable Costs.

(P) **"Full Implementation Date"** shall have the meaning provided therefor in the Interlocal Agreement.

(Q) **"Hillsborough"** shall mean Hillsborough County, Florida, a political subdivision of the State of Florida, acting by and through its Board of County Commissioners.

(R) **"Hillsborough's Water Service Area"** shall mean the geographic boundaries within which Hillsborough is permitted and authorized to provide Water Service.

(S) **"Inspection Report"** shall mean a report of the conditions and accuracy of the Metering Facilities which shall be prepared for the Authority by a representative of the manufacturer of the Metering Facilities or by a third-party selected by the Authority and which shall be submitted to the Member Governments as required by Section 11 hereof.

(T) **"Interlocal Agreement"** shall mean that certain Amended and Restated Interlocal Agreement, by and among the Member Governments, dated as of May 1, 1998, as the same may be amended or supplemented from time to time. Such Amended and Restated Interlocal Agreement shall be the successor instrument to the Interlocal Agreement, dated October 25, 1974, as amended, among Hillsborough, Pasco, Pinellas, St. Petersburg and Tampa.

(U) **"Long Term Forecast"** shall mean the forecast setting forth the next twenty (20) Fiscal Years of anticipated Water Service for each of the Member Governments for the development and use of their respective Water Service Areas, which Long Term Forecast shall be submitted to the Authority as of the Effective Date hereof. The Long Term Forecast may be amended by the Member Governments from time to time as part of the Annual Report.

(V) **"Master Water Plan"** shall mean the Authority's plan for expansion, conservation, diversification and preservation of Water supply for the Water Service Areas, as set forth in Exhibit B attached hereto, as the same may be amended or superseded from time to time.

(W) **"Member Governments"** shall mean, collectively, Hillsborough, New Port Richey, Pasco, Pinellas, St. Petersburg and Tampa.

(X) **"Metering Facilities"** shall mean, collectively, those certain water meters and appurtenant recording and transmitting devices to be installed and owned by the Authority, as required by Section 11 hereof, which are used to measure and bill the volume of Quality Water being delivered to each of the Member Governments.

(Y) **"New Port Richey"** shall mean the City of New Port Richey, Florida, a municipal corporation of the State of Florida, acting by and through its Mayor and City Council.

(Z) **"New Port Richey's Water Service Area"** shall mean the geographic boundaries within which New Port Richey is permitted and authorized to provide Water Service.

(AA) **"Obligations"** shall mean the Series 1998 Bonds and any other series of bonds or other evidence of indebtedness, including, but not limited to, notes, commercial paper, capital leases or any other obligations of the Authority heretofore or hereafter issued or incurred.

(BB) **"Operating Reserve Funds"** shall mean those funds which are deemed by the Authority as necessary to meet any cash flow and revenue collection shortfalls due to

inaccuracies in the Annual Reports or Annual Estimates or due to the requirements of the Financing Documents. The amount of Operating Reserve Funds shall be established by Authority policy; provided such amount shall not exceed an amount equal to two times the monthly average Variable Costs as provided in the Authority's preliminary budget.

(CC) "**Operation, Maintenance and Administrative Costs**" shall mean any and all costs incurred by the Authority in operating, maintaining and administering the System, including, but not limited to, the general administrative and legal costs of the Authority related to operation, maintenance, management, security and development of the System; costs associated with tools, equipment, vehicles, supplies, materials, services and support for the operation, maintenance, management, security and development of the System; any costs of litigation or a legal judgment against the Authority; costs relating to Water conservation and public education activities; costs of purchasing any Water; development expenses relating to expansion of the System; all costs incurred in planning or applying for, obtaining, maintaining and defending Environmental Permits which shall not be paid from the Capital Improvement Charge; accounting, legal and engineering expenses; ordinary and current rentals of equipment or other property; refunds of moneys lawfully due to others; pension, retirement, health and hospitalization funds; payments in lieu of taxes and facility impact fees; moneys to be deposited to a rate stabilization fund; and fees for management of the System or any portion thereof.

(DD) "**Pasco**" shall mean Pasco County, Florida, a political subdivision of the State of Florida, acting by and through its Board of County Commissioners.

(EE) **"Pasco Water Service Area"** shall mean the geographic boundaries within which Pasco is permitted and authorized to provide Water Service.

(FF) **"Pinellas"** shall mean Pinellas County, Florida, a political subdivision of the State of Florida, acting by and through its Board of County Commissioners.

(GG) **"Pinellas Water Service Area"** shall mean the geographic boundaries within which Pinellas is permitted and authorized to provide Water Service.

(HH) **"Points of Connection"** shall mean those points where the Member Governments' water utility systems connect to the Authority's System for the purpose of delivering Quality Water from the Authority's System to the Member Governments, which Points of Connection are more particularly described on Exhibit C to this Contract.

(II) **"Primary Environmental Permit"** shall have the meaning provided therefor in the Interlocal Agreement.

(JJ) **"Quality Water"** shall mean Water which (1) meets State and federal drinking water regulations and standards as defined in Rule 62-550, Florida Administrative Code, as it may be amended or superseded from time to time, including regulations pertaining to surface water or groundwater under the direct influence of surface waters, but excluding regulations pertaining to disinfection and corrosivity, and (2) would not cause a particular Member Government utility to adopt new treatment techniques beyond modified chemical dosages and/or optimization of existing unit processes to meet a moderately altered source of Water. Except as otherwise provided herein, the provisions of this definition are not intended as permission for a Member Government to reject the type of Quality Water to be provided by the Authority to such Member Government;

provided, however, the Authority shall pay for any additional treatment costs required to meet the standards for Quality Water as described herein. In addition, Quality Water shall meet the standards provided in Exhibit D attached hereto. The term "Quality Water" also includes Water delivered to the Points of Connection identified in Section 3.03(D) of the Interlocal Agreement or to Points of Connection at which a Member Government agrees, at its sole option, to accept Water not meeting the standards for Quality Water pursuant to Section 3.03(E) of the Interlocal Agreement.

(KK) "**Production Failure**" shall have the meaning provided therefor in the Interlocal Agreement.

(LL) "**Renewal and Replacement Charges**" shall mean those certain charges to be deposited to any renewal and replacement fund or account established pursuant to the Financing Documents.

(MM) "**Series 1998 Bonds**" shall mean the Authority's Utility Revenue Bonds, Series 1998. The Series 1998 Bonds may be issued in more than one series.

(NN) "**St. Petersburg**" shall mean the City of St. Petersburg, Florida, a municipal corporation of the State of Florida, acting by and through its Mayor and City Council.

(OO) "**St. Petersburg Water Service Area**" shall mean the geographic boundaries within which St. Petersburg is permitted and authorized to provide Water Service.

(PP) "**State**" shall mean the State of Florida.

(QQ) "**SWFWMD**" shall mean the Southwest Florida Water Management District, an agency of the State of Florida, created pursuant to Chapter 373, Florida Statutes, or any successor agency.

(RR) "**Tampa**" shall mean the City of Tampa, Florida, a municipal corporation of the State of Florida, acting by and through its Mayor and City Council.

(SS) "**Tampa Water Service Area**" shall mean the geographic boundaries within which Tampa is permitted and authorized to provide Water Service.

(TT) "**Transferred Assets**" shall mean the Water Supply Facilities (including real property, tangible personal property and intangible personal property) conveyed to the Authority pursuant to Sections 5.01, 5.02, 5.03, 5.04, 5.05 and 5.06 of the Interlocal Agreement; provided, however, that any equity interest of the Member Governments in the Existing Authority System that is relinquished pursuant to Sections 5.01, 5.02, 5.03, 5.04, 5.05 and 5.06 of the Interlocal Agreement shall not constitute a "Transferred Asset."

(UU) "**Variable Costs**" shall mean all costs and expenses of the Authority for the operation, maintenance and management of the System that change in direct proportion to changes in the volume of Water produced by the Authority, including, but not limited to, power, chemical and Water purchases.

(VV) "**Water**" shall mean Quality Water and any other water to be used by a Member Government in its public water supply system.

(WW) "**Water Service**" shall mean the provision of Water as required in the Interlocal Agreement to any and all of the Member Governments at the locations described

in Exhibit C attached hereto and provision of Water by the Member Governments to their customers.

(XX) **"Water Service Areas"** shall mean, collectively, the Hillsborough Water Service Area, the New Port Richey Water Service Area, the Pasco Water Service Area, the Pinellas Water Service Area, the St. Petersburg Water Service Area and the Tampa Water Service Area. The Water Service Areas are described in Exhibit E attached hereto, as the same may be amended or supplemented from time to time pursuant to the terms hereof.

(YY) **"Water Supply Facilities"** shall mean Water production, treatment and transmission facilities. The term "Water Supply Facilities" does not include facilities for local distribution.

SECTION 4. TERM. The term of this Contract shall begin on the Effective Date and shall end on the later of (A) the date the Interlocal Agreement is terminated in accordance with the provisions thereof, or (B) the date on which no Obligations shall remain outstanding pursuant to the Financing Documents.

SECTION 5. CONDITIONS PRECEDENT. This Contract shall become effective upon satisfaction of the following conditions precedent:

(A) Execution of Contract. This Contract shall be duly authorized, executed and delivered by the Authority, Hillsborough, New Port Richey, Pasco, Pinellas, St. Petersburg and Tampa.

(B) Series 1998 Bonds. The Authority shall have issued the Series 1998 Bonds.

(C) The Transferred Assets. The Transferred Assets shall have been conveyed to the Authority as provided in the Interlocal Agreement.

(D) Interlocal Agreement. All conditions described in Sections 6.03(A) and (D) of the Interlocal Agreement shall have been satisfied or waived in writing by the Member Governments.

(E) Certification of Representations. Each of the parties hereto shall certify that the representations described in Section 7 hereof are true and accurate in all material respects as of the Effective Date.

SECTION 6. SATISFACTION OF THE CONDITIONS PRECEDENT. The Authority and each Member Government shall provide a written statement acknowledging the satisfaction of conditions of Section 5 hereof; provided, however, no Member Government shall be required to acknowledge satisfaction of any condition of which such Member Government has no knowledge. Receipt of such statements shall be conclusive evidence of the satisfaction of such conditions. All conditions precedent must be satisfied by the Full Implementation Date, otherwise all provisions hereof shall be void ab initio.

SECTION 7. REPRESENTATIONS OF THE PARTIES. As of the Effective Date, the Authority, Hillsborough, New Port Richey, Pasco, Pinellas, St. Petersburg and Tampa each make the following representations as it relates to itself (no representation is made by any party for any other party):

(A) Status of the Parties. The Authority, Hillsborough, New Port Richey, Pasco, Pinellas, St. Petersburg and Tampa are each duly organized, validly existing and in good

standing under the laws of the State and are each duly qualified and authorized to satisfy their responsibilities pursuant to this Contract.

(B) Authority to Enter the Contract. The Authority, Hillsborough, New Port Richey, Pasco, Pinellas, St. Petersburg and Tampa each have the power, authority and legal right to enter into and perform the obligations set forth in this Contract, and the execution, delivery and performance hereof by the Authority, Hillsborough, New Port Richey, Pasco, Pinellas, St. Petersburg and Tampa: (i) has been duly authorized by the Board of Directors in the case of the Authority, by the Board of County Commissioners in the case of Hillsborough, Pasco and Pinellas, by the Mayor and City Council in the case of New Port Richey and Tampa and by the City Council in the case of St. Petersburg; (ii) does not require any consent or referendum of the voters; and (iii) does not constitute a default under, or result in the creation of any lien, charge, encumbrance or security interest upon, the assets of the Authority or any of the Member Governments under any agreement or instrument to which the Authority or any of the Member Governments is a party or by which the Authority or any of the Member Governments and their assets may be bound or affected, except as otherwise provided herein.

(C) Validity of the Contract. This Contract has been duly entered into and delivered by the Board of the Directors in the case of the Authority, the Board of County Commissioners in the case of Pasco, Hillsborough and Pinellas, by the City Council and Mayor in the case of New Port Richey, St. Petersburg and Tampa and, as of the Effective Date, constitutes a legal, valid and binding obligation of the Authority and the Member Governments, fully enforceable in accordance with its terms, except to the extent that the

enforceability of this Contract may be limited by any applicable bankruptcy, moratorium, reorganization or other similar laws affecting creditor's rights generally, or by the exercise of judicial discretion in accordance with general principles of equity.

(D) Pending Litigation. Other than matters previously disclosed in writing to the parties hereto, there is no action, suit or proceeding, at law or in equity, before or by any court or governmental authority, pending against the Authority or any of the Member Governments, wherein any unfavorable decision, ruling or finding would materially and adversely affect the performance by the Authority or any of the Member Governments of their obligations hereunder or the other transactions contemplated hereby, or which, in any way, would adversely affect the validity or enforceability of this Contract, or any other agreement or instrument entered into by the Authority in connection with the transactions contemplated hereby.

SECTION 8. AUTHORITY'S AGREEMENT TO PROVIDE WATER SERVICE. (A) Provision of Water Service. The Authority shall sell and deliver sufficient Quality Water to the Member Governments to meet their need for Quality Water and the Member Governments shall purchase and receive the Quality Water delivered by the Authority to meet their needs in accordance with the terms of this Contract; subject, however, to the representations, conditions, limitations and restrictions set forth in this Contract and the Interlocal Agreement. Except as provided in the Interlocal Agreement, Water Service obtained by the Member Governments from the Authority may be utilized to serve only the Member Governments or their customers within their respective Water Service Areas. Nothing herein shall be construed to prohibit the Member Governments

from temporarily exchanging or purchasing Water, either among themselves or with other public or private utilities, for emergency or maintenance purposes in the ordinary course of business.

(B) Insufficient Water. The Authority shall be in default hereunder should it fail to provide to each Member Government a supply of Quality Water sufficient to meet its needs, except where the Authority's failure to supply the Quality Water needs of each Member Government is due to force majeure, as described in Section 21(E) hereof. In the event that there is, at any time, an insufficient supply of Quality Water available to fulfill the needs of the Member Governments due to force majeure described in Section 21(E) hereof, the Authority shall not be in default hereunder, if, in such circumstances, it shall furnish and deliver to the Member Governments, their pro rata share (or a share that as closely approximates their pro rata share as is reasonably practicable in the circumstances) of available supply, unless otherwise required by law, court order, or appropriate regulatory authorities. Each Member Government's pro rata share shall be based on the average of the actual amount of Quality Water supplied each month by the Authority to such Member Government over the previous twelve (12) month period. The Authority shall use its best efforts to prevent an insufficiency of Quality Water and to remedy any such insufficiency and shall take all necessary actions to supply the Quality Water needs of each Member Government in accordance with the terms of the Interlocal Agreement.

(C) Water Use Restrictions. In the event of an insufficiency in the supply of Quality Water described in the preceding paragraph, the Authority may request the

Member Governments to implement water use restrictions which shall be applied on a uniform basis among all Member Governments. In the event a Member Government does not implement such a request within thirty (30) days of the request and the insufficiency in available Quality Water is still present, the Member Governments agree to implement water use restrictions upon request of the Authority. The purposes of such restrictions shall be to reduce demand for Quality Water among Member Governments and to ensure that a particular Member Government or Governments does not unduly suffer as a result of such insufficiency.

(D) Member Government's Rights During Production Failure. Nothing in this Section 8 shall affect a Member Government's rights under Section 3.17 of the Interlocal Agreement in the event of a Production Failure.

SECTION 9. MEMBER GOVERNMENTS' WATER SERVICE. Except as otherwise provided herein or in the Interlocal Agreement, all Water required to service the customers within the respective Water Service Areas shall be supplied by the Authority. Nothing herein shall be construed to prohibit the Member Governments from temporarily exchanging or purchasing Water, either among themselves or with other public or private utilities, for emergency or maintenance purposes in the ordinary course of business. A Member Government shall notify the Authority in writing of any change in its Water Service Area. Authority approval of a change in a Member Government's Water Service Area is not required except if such change involves providing Water outside its boundaries in the case of a Member Government which is a county or the boundaries of the county where the Member Government is located in the case of a Member Government which is a

municipality. The parties hereto agree that Pasco may provide Water Service in Hillsborough to customers in the Wyndham Lakes Subdivision.

SECTION 10. POINTS OF CONNECTION AND METER LOCATIONS. (A)

Points of Connection. The Points of Connection and the location of the Metering Facilities (which shall include master meters) that will be used to connect the Member Governments' water utility systems and the Authority's System, for Quality Water, shall be as provided in Exhibit C hereto. Each Member Government may have more than one Point of Connection with the Authority's System. Any change in the Points of Connection for a Member Government shall be incorporated by reference in Exhibit C hereto. The parties may, by mutual written agreement, more specifically identify or modify said Points of Connection or the location of the Metering Facilities, and any such additional legal description or modifications shall be considered to be a part of this Contract, as if initially set forth herein. After thirty (30) days written notice to the Authority, and with the Authority's prior written approval, not to be unreasonably withheld, delayed or conditioned, the Member Governments may, at any time, at their sole cost and expense, relocate or modify the location of the Points of Connection, as long as said relocation does not unreasonably interrupt, impair or interfere with the ability of the Authority to provide Water Service to the respective Water Service Area or service to other customers of the Authority. At the request and expense of a Member Government, the Authority may relocate or modify the location of a Point of Connection. In the event the Authority on its own initiative desires to modify a Point of Connection for a Member Government, it must

receive the approval of such Member Government, which approval shall not be unreasonably withheld, and it must pay the expenses of such modification.

(B) Conveyance of Easements. It shall be the duty of the Authority to install, operate and maintain any required Metering Facilities at the Points of Connection, as set forth in Section 11 hereof. The Member Governments shall convey to the Authority, as and when the Authority requests, at no cost and expense to the Authority, an appropriate non-exclusive easement over, under or above such portions of the Water Service Areas as may be reasonably requested by the Authority for the installation, operation and maintenance of such Metering Facilities at the Points of Connection. Such grants of non-exclusive easements shall be adequate to meet the Authority's needs but need not be more than the minimum required, according to generally accepted engineering standards, in order to perform the functions requiring said non-exclusive easements. No other easement granted by the respective Member Government over, under or above such portions of the Water Service Areas shall unreasonably interfere with the ability of the Authority to duly and properly install, operate or maintain the Points of Connection and Metering Facilities. The Authority shall acquire any property it requires for easements at the metering location and Points of Connection if not already owned by a Member Government.

(C) Pumping Stations. If a booster pump station is required to meet pressure described in Exhibit C hereto at a Point of Connection, the booster pump station shall be constructed, owned and operated by the Authority or, in the alternative at the option of the Authority, a Member Government may construct, own and operate such booster pumping

station, provided a credit shall be issued to such Member Government reflecting the Authority's avoided cost or the Member's actual cost, whichever is less. The Member Governments agree to provide available sites for future pump stations to the Authority at fair market value so that the Authority can carry out its obligations to provide adequate pressure to all Member Governments.

SECTION 11. METERING FACILITIES. (A) Installation of Metering Facilities.

The Authority shall acquire and install such Metering Facilities as are adequate in view of the Member Governments' right to receive Water Service and as will accurately measure the volume of Quality Water delivered to Member Governments by the Authority. The Authority shall retain ownership of the Metering Facilities, together with any appurtenances thereto. The type of Metering Facilities selected shall be at the discretion of the Authority, subject to compliance with industry standards for similar Metering Facilities.

(B) Inspection of Metering Facilities. Visual inspection and routine maintenance of the Metering Facilities and appurtenances thereto shall be performed annually by the Authority, and the Authority shall prepare or shall have prepared an Inspection Report regarding the condition, accuracy and state of the Metering Facilities. The Inspection Report shall be prepared at the Authority's expense by a representative of the manufacturer of the Metering Facilities or a third-party reasonably acceptable to the Authority and the Member Governments, and a copy of each such Inspection Report shall be furnished to the Member Governments. The Authority shall perform or have performed

annually at its expense a certified calibration test of the Metering Facilities and submit the results thereof to the Member Governments.

Upon request and at the expense of a Member Government, the Authority shall make arrangements for a meter test to be conducted by an independent testing facility.

The Authority shall be responsible for negotiating and paying to the independent meter testing facility any fees charged for such a test. Such independent meter testing facilities shall conform to the manufacturer's standards. Where appropriate, the meter may be field tested. The Member Governments shall have the right to observe any field test, and the Authority shall provide the Member Governments with a written report of the results of each such test.

(C) Inaccurate Meters. The Authority shall employ water meters that register within the accuracy limits provided by the manufacturer. Should the accuracy of any of the Metering Facilities be determined to be inaccurate beyond limits prescribed in applicable Environmental Permits, such Metering Facilities will be assumed to have been inaccurate since the last annual Inspection Report, calibration or the last field test or for a period of six (6) months, whichever is less, and the following month's billing will be adjusted taking into account the nature of the inaccuracy to show a credit or additional charge to the respective Member Governments for metered flow for that period. Inaccuracies which are not beyond the limits prescribed in applicable Environmental Permits shall not be credited or charged to the affected Member Governments.

SECTION 12. ANNUAL REPORT. Commencing on the Effective Date hereof and by February 1 of each year thereafter, each Member Government shall supply the

Authority with an updated Annual Report, in the form provided in Exhibit K attached hereto, setting forth the next five (5) Fiscal Years of projected Water Service demand within their respective Water Service Areas. Such projected Water Service demand shall state its projected average day and maximum day Water Service requirements. The Annual Report shall include a Long Term Forecast. The Long Term Forecast shall set forth the next twenty (20) Fiscal Years of projected Water Service demand within the respective Water Service Areas. At the Authority's request, such Member Government shall furnish to the Authority its back-up and supporting information, data and projections that form the basis of any Annual Report or Long Term Forecast. The Annual Reports shall be utilized by the Authority in formulating its capital improvement program; provided the Authority agrees that such Annual Reports are only one factor in formulating its capital improvement program and it further agrees not to rely exclusively on such Annual Reports in its determination of the Quality Water needs of the Member Governments.

SECTION 13. RATE. (A) Authority's Annual Estimate. No later than April 15 of each year during the term of this Contract, the Authority shall submit to the Member Governments the Annual Estimate which shall set forth the anticipated cost to the Authority of providing Water Service to the Member Governments for the forthcoming Fiscal Year. The Annual Estimate shall be based upon the Authority's proposed budget for such Fiscal Year. The Annual Estimate shall describe the Fixed Costs and Variable Costs of the Authority. The Annual Estimate may be revised from time to time to reflect changes to the Authority's budget. The Authority's budget shall be approved as provided in the Interlocal Agreement.

(B) Rate. The rate in effect each Fiscal Year shall be sufficient to pay the Annual Estimate established by the Authority. During the term of this Contract, the Member Governments irrevocably agree to pay to the Authority, as compensation for the Water Service received by such Member Governments, a monthly charge for such Water Service based on the rate approved by the Authority and total volume of Quality Water delivered to such Member Governments by the Authority. In addition, the Authority's rate structure may provide for debits and credits for different levels of treatment of Quality Water required of the Authority or a Member Government as described in Section 3.04 of the Interlocal Agreement. The Authority shall also provide for credits to those Member Governments who do not elect to take cash, in whole or in part, for the sale of their Transferred Assets to the Authority as provided in the Interlocal Agreement. The Authority and the Member Governments agree that the rate for Water delivered to Tampa from the Tampa Bypass Canal shall be established pursuant to the provisions of Section 3.08(D) of the Interlocal Agreement. The Member Governments shall be billed on a monthly basis in accordance with bills rendered by the Authority to each Member Government. The monthly bills delivered by the Authority to the Member Governments shall consist of two components. The first component shall be a charge for the Fixed Costs of the Authority. Each Member Government shall pay monthly an amount equal to one-twelfth of the Fixed Costs provided in the Annual Estimate times $\frac{A}{B}$, whereby A equals the amount of Quality Water delivered to such Member Government during the previous Fiscal Year and B equals the total amount of Quality Water delivered to all of the Member Governments during such Fiscal Year. The amount of Fixed Costs payable by the Member Governments

shall be subject to a true-up pursuant to Section 13(E) hereof. The second component of each monthly bill shall be the charge for the Variable Costs. Each Member Government shall pay an amount equal to the amount of Quality Water consumed by the Member Government during the prior month times the rate then in effect times $\frac{C}{D}$, whereby C equals the Variable Costs and D equals the Annual Estimate then in effect. All bills shall become due within thirty (30) days of receipt thereof by a Member Government.

(C) Rate Setting. The initial rate for Water Service to be charged by the Authority to the Member Governments is contained in Exhibit F to this Contract. Between April 15 and August 1 of each Fiscal Year, the Authority may prepare and approve an adjustment to the Water Service rate then in effect, if appropriate, based on the Authority's Annual Estimate of providing Water Service to the Member Governments during such period during which the adjustment will be in effect. Any rate adjustment put into effect as part of the Authority's budget process described above shall become effective no earlier than the next succeeding October 1. The Authority may also prepare and approve an adjustment to the rate at such other time or times as shall be required by the Financing Documents.

The rate to be charged in a Fiscal Year to the Member Governments for Water Service may include the following components:

- (i) Operation, Maintenance and Administrative Costs. Operation, Maintenance and Administrative Costs shall be based on the cost of service provided by the Authority in such Fiscal Year.

(ii) Debt Service Charges. Debt Service Charges relating to any Authority's Obligations shall be based upon the payment of, redemption premium, if any, and interest coming due on the Obligations in such Fiscal Year.

(iii) Renewal and Replacement Charges. Renewal and Replacement Charges shall be based on an engineering estimate by the Authority's consulting engineer of amounts to be deposited into the renewal and replacement fund or account at a level sufficient to satisfy in such Fiscal Year all requirements of covenants given or undertaken by the Authority in the Financing Documents.

(iv) Bond Coverage Costs. Bond Coverage Costs shall be based upon coverage requirements established by the Financing Documents.

(v) Capital Improvement Charges. Capital Improvement Charges shall be based upon the amount identified therefor in the Authority's Annual Estimate for such Fiscal Year.

(vi) Operating Reserve Funds. Operating Reserve Funds shall be based upon the amount identified therefor in the Authority's Annual Estimate for such Fiscal Year.

The Member Governments agree that the Authority may establish a rate stabilization fund. Operation, Maintenance and Administrative Costs and/or Operating Reserve Funds may be utilized by the Authority to fund such rate stabilization fund.

(D) Procedure for Rate Adjustments. Prior to the adoption of any proposed new or adjusted rate, the Authority shall provide to the Member Governments its proposed rate, with supporting data and calculations. Any disagreements in the proposed rate shall be

submitted for determination in the manner and mode set forth in Section 19 hereof. Notwithstanding any disagreement by any such Member Government of the proposed rate, the Authority may, nonetheless, implement said proposed rate at any time not less than sixty (60) days after receipt thereof by the Member Governments. Upon completion of the determination regarding the propriety of the proposed rate, pursuant to the procedures set forth in Section 19 hereof, the rate so determined to be proper shall become the adopted and approved adjusted rate. If the proposed rate is determined to have been in excess of the rate permitted under this Contract, in whole or in part, then the Authority shall, within thirty (30) days of said determination, refund to such Member Government the difference between the proposed rate collected by the Authority and the rate found to be proper pursuant to the determination made under Section 19 hereof.

A copy of the Authority's rate, as it may be adjusted or proposed from time to time, is intended to be incorporated herein by this reference, and shall be considered to be attached hereto as Exhibit F.

(E) Annual True-Up. Following the end of each Fiscal Year, an annual adjustment in the Fixed Costs component of bills paid during that Fiscal Year shall be computed on the basis of (i) the Fixed Costs which are provided in the Annual Estimate in effect during the Fiscal Year then ended and (ii) the actual amount of Quality Water delivered to each of the Member Governments during the Fiscal Year then ended. The Authority shall determine the amount of Fixed Costs payable by each Member based upon actual delivery of Quality Water during the previous Fiscal Year. Such determination shall be made within forty-five (45) days of the end of the Fiscal Year. In the event the determination reflects

that an underpayment has been made by a Member Government as a result of consumption of an increased amount of Water by such Member Government, then the full amount due and owing for said underpayment shall be paid by the Member Government to the Authority within sixty (60) days of the Member Government's receipt of the determination. In the event the determination reflects that an overpayment has been made by a Member Government as a result of consumption of a lesser amount of Quality Water by such Member Government, then the amount of said overpayment shall be paid to the Member Government within sixty (60) days following distribution of the determination. Neither underpayments nor overpayments shall bear interest. Each such adjustment in payments shall be verified by the Authority's annual audit. The annual audit shall be distributed to the Member Governments on or before March 1 of the year following the end of each Fiscal Year. The Authority shall adjust any overpayments or underpayments to reflect the Quality Water consumption amounts provided in the annual audit.

(F) Carry-Forward. Any unencumbered moneys of the Authority present at the end of a Fiscal Year shall be budgeted by the Authority for the succeeding Fiscal Year and shall be utilized for the same purposes for which rates are charged by the Authority to the Member Governments pursuant to this Section 13.

SECTION 14. PLEDGE OF CONTRACT REVENUES. The Authority is hereby authorized to pledge all payments due, owing or received by Member Governments pursuant to the terms hereof, any interest or other income derived from moneys received under this Contract and any other moneys of the Authority for the purpose of securing the Obligations issued by the Authority.

SECTION 15. DEVELOPMENT OF NEW WATER SUPPLY SOURCES.

Unless prevented by force majeure, as described in Section 21(E) hereof, the Authority will develop new Water Supply Facilities as provided in the Interlocal Agreement in order to meet the Quality Water supply needs of the Member Governments. The Authority and the Member Governments realize that the development of new water supply sources and the implementation of the Master Water Plan are paramount to the Authority's ability to fulfill its Water Service obligations under this Contract, and the parties hereby agree to work together toward accomplishing the objectives set forth in the Master Water Plan and the Interlocal Agreement.

SECTION 16. MEMBER GOVERNMENTS' RIGHTS TO DEVELOP AND SUPPLY WATER. Member Governments may develop Water Supply Facilities or purchase Water from persons other than the Authority only to the extent provided in the Interlocal Agreement.

SECTION 17. ADDITIONAL REPRESENTATIONS, WARRANTIES AND COVENANTS OF THE AUTHORITY. The Authority hereby represents, warrants and covenants to the Member Governments as follows:

(A) Water Quality. The Authority shall deliver to the Member Governments Quality Water from the Authority's System at the Points of Connection. Upon the request, and at the expense, of a Member Government and upon the conditions described in Section 3.04 of the Interlocal Agreement, the Authority may provide additional treatment to the Quality Water.

(B) Environmental Permits. The Authority shall obtain, renew, maintain and modify, if necessary, all Environmental Permits necessary to provide Water Service to the Water Service Areas in accordance with the terms of the Interlocal Agreement. The Authority further agrees to comply with all Environmental Permit conditions and applicable rules and regulations.

(C) Financing Water Supply Facilities. The Authority shall from time to time issue such Obligations as it deems necessary to cover the costs incurred in constructing, acquiring, operating, replacing and expanding the Authority's System; provided any Obligations issued to finance operating expenses shall mature no later than one year from the date of their issuance.

(D) Accounting. The Authority shall maintain accounts and records for all funds received and disbursed by it with respect to Water Service. On or before each March 1, beginning on the March 1 immediately following the date upon which all conditions precedent in Section 5 hereof are satisfied, the Authority shall complete an audit of the aforesaid accounts. Said audit shall be conducted by a nationally recognized certified public accounting firm.

(E) Adequate Water and Environmental Effects. The Authority shall supply Water Service to the Member Governments and reduce adverse environmental effects of excessive or improper withdrawals of Water from concentrated areas as provided herein and in the Interlocal Agreement.

(F) Conservation. The Member Governments shall have primary responsibility for implementing means, methods and techniques relating to Water conservation;

provided, however, the Authority may continue to plan and coordinate the conservation efforts of the Member Governments.

(G) Operation of System. The Authority shall at all times operate and maintain the System in accordance with prudent utility practices.

(H) Compliance with Laws. The Authority shall comply with all laws, rules and regulations applicable to this Contract and its obligations arising hereunder.

(I) Equitable Treatment of Member Governments. The Authority shall treat all Member Governments equitably without preference for any one Member Government over another Member Government, all in accordance with the terms of this Contract and the Interlocal Agreement.

(J) Rate. The rate charged by the Authority to the Member Governments for Water Service shall be reasonable.

SECTION 18. ADDITIONAL REPRESENTATIONS, WARRANTIES AND COVENANTS OF THE MEMBER GOVERNMENTS. The Member Governments hereby represent, warrant and covenant to the Authority as follows:

(A) Irrevocable Commitment to Pay. The Member Governments shall pay their respective monthly bills for Water Service to their respective Water Service Areas for every Fiscal Year throughout the term of this Contract in the manner provided in Section 13 hereof. Said payments by the parties shall be made without notice or demand and without set-off, counterclaim, abatement, suspension or deduction. The Authority is undertaking the acquisition, construction, operation, replacement and expansion of the

Authority's System on the representations, warranties and covenants of the Member Governments set forth in this Section 18.

(B) Acquisition of Real Property. The Member Governments shall cooperate with the Authority in acquiring all interests in real property necessary to acquire, construct, manage, operate and expand the Authority's System.

(C) Member Governments' Water Utility System Charges. The Member Governments shall fix, revise, maintain and collect such fees, rates, tariffs, rentals, or other charges for the use of products, services and facilities of their respective Member Government's water utility systems to the extent necessary to fund the timely payment of their respective obligations and liabilities under this Contract.

(D) Member Governments' Water Utility System Operation and Maintenance Account. Except as otherwise provided herein, the Member Governments shall maintain their Member Governments' water utility system operation and maintenance accounts throughout the term of this Contract for the purpose of paying their obligations and liabilities under this Contract. At all times during the term of this Contract, the parties' obligations and liabilities under this Contract shall be considered an operating expense of their water utility systems and shall be paid from their water utility systems operation and maintenance accounts; provided, however, that such obligations and liabilities of a Member Government shall not be considered an operating expense of its water utility system nor need it be paid from the operation and maintenance account to the extent the Member Government has budgeted and appropriated legally available moneys for such purpose and is current on all its obligations arising hereunder.

(E) Member Government Payment Obligation. A Member Government shall not be liable under this Contract for the obligations of any other Member Government. A Member Government shall be solely responsible and liable for performance of its obligations under this Contract. The obligation of a Member Government to make payments under this Contract is a severable obligation and not a joint obligation with the other Member Governments.

(F) Cooperation on Issuance of Authority Obligations. Each Member Government shall cooperate with the Authority in issuance of the Authority's Obligations. In such connection, each Member Government and the Authority shall comply with reasonable requests of each other and will, upon request, do as follows: (i) make available general and financial information about itself; (ii) consent to publication and distribution of its financial information; (iii) certify that its general and financial information is accurate, does not contain any untrue statements of a material fact and does not omit to state a material fact necessary to make the statements in the information, in light of circumstances under which they are made, not misleading; (iv) make available certified copies of official proceedings; (v) provide reasonable certifications to be used in a transcript of closing documents; and (vi) provide and pay for reasonable requested opinions of counsel as to the validity of its actions taken in respect to and the binding effect of the Interlocal Agreement and this Contract, title to its Water supply system, as applicable, and pending litigation which could materially affect its performance hereunder. In addition, each Member Government agrees to take no action which shall adversely affect the exclusion from gross income of interest on the Authority's Obligations for

purposes of federal income taxation. Each Member Government shall provide the Authority reasonable assurance that no actions taken by it shall adversely affect the exclusion from gross income of interest on the Authority's Obligations for purposes of federal income taxation. Each Member Government further agrees that it shall pay any arbitrage rebate liability arising pursuant to Section 148 of the Internal Revenue Code of 1986, as amended, from the use or investment of proceeds of the Series 1998 Bonds which are paid to such Member Government for acquisition of its Transferred Assets by the Authority.

SECTION 19. ARBITRATION. (A) Arbitration. Except as otherwise provided in this Section 19, any disputes respecting monetary defaults committed by the Authority or any of the Member Governments, any disputes regarding Water quality as provided in Exhibit D hereto, and any disputes between the Authority and any Member Government involving fiscal matters arising under this Contract, which are not otherwise resolved after due diligent effort by the parties, shall be resolved through binding arbitration in accordance with the following provisions of this Section 19. Such binding arbitration shall be the sole and exclusive method of resolving disputes described above.

(i) Arbitration shall be commenced by one party serving written notice upon on the other parties of its demand to arbitrate. Within sixty (60) days after actual receipt of a written demand to arbitrate, the parties shall proceed with arbitration. Within said sixty (60) days, the Authority and the Member Government each shall appoint a person as arbitrator. Each appointment shall be signified in writing by each party to the other, and the arbitrators so appointed shall, within ten

(10) days of their appointment, appoint a third arbitrator and who shall chair the panel. If the arbitrators appointed by the parties are unable to agree upon a third arbitrator, the third arbitrator shall be appointed by the American Arbitration Association from its qualified panel of arbitrators. If the Authority or the Member Government fails to appoint an arbitrator within sixty (60) days after receipt from the other party of a written demand to arbitrate, then the arbitrator appointed by the party not in default hereunder shall appoint a second arbitrator and the two so appointed shall appoint a third arbitrator to chair the panel. None of the arbitrators shall have a business or other pecuniary relationship with either party, except for payment of the arbitrator's fees and expenses.

(ii) In the event a dispute arises involving the Authority and more than one Member Government in regard to the same subject matter, such parties may agree to one arbitration proceeding to settle such a dispute. Within sixty (60) days of such agreement, the Authority, individually, and the Member Governments, collectively, shall each appoint a person as arbitrator. Each appointment shall be signified in writing by each party to the other parties and the arbitrators so appointed shall, within ten (10) days of their appointment, appoint a third arbitrator who shall chair the panel. If the arbitrators appointed are unable to appoint a third, such third arbitrator shall be appointed by the American Arbitration Association from its qualified panel of arbitrators. If either the Authority or the Member Governments fail to appoint an arbitrator within sixty (60) days after agreement to proceed with a single arbitration, then the arbitrator appointed shall appoint a second arbitrator

and the two so appointed shall appoint a third arbitrator to chair the panel. None of the arbitrators shall have a business or other pecuniary relationship with any of the parties, except for payment of the arbitrator's fees and expenses.

(iii) The three arbitrators, after being duly sworn to perform their duties with impartiality and fidelity, shall proceed to determine the questions submitted.

The arbitrators may, at their discretion, and shall, upon the written request of either the Authority or the Member Government(s), engage experts to provide peer review of any scientific and technical studies introduced by parties. The arbitration hearing shall convene not earlier than ninety (90) days and not later than one hundred twenty (120) days of the appointment of the chair by the arbitrators, unless the parties agree to an earlier date. The arbitrators shall render an award within sixty (60) days of the conclusion of the arbitration hearing, and such award shall be in writing and in duplicate, one counterpart thereof to be delivered simultaneously to each of the parties. The award shall contain findings of fact and conclusions of law and shall be final and binding upon the parties involved.

(iv) The fees, charges and expenses of such arbitrators and any experts engaged by the arbitrators shall be borne equally by the parties. The fees of respective counsel engaged by the parties, and the fees of expert witnesses and other witnesses called by the parties shall be paid by the respective party engaging such counsel or engaging such witnesses.

(v) Except to the extent inconsistent with this Section 19, the American Arbitration Association standards shall apply to any arbitration proceedings

conducted under the provisions of this Section 19. The venue for any such action shall be the county in which the Authority maintains its principal office. Discovery shall be conducted pursuant to the rules set forth in Exhibit L attached hereto unless all parties to the proceeding agree to modify such rules.

(B) Continuation of Payments. The Member Governments agree that during any such period of arbitration, they shall continue to promptly make all payments due to the Authority, pursuant to the terms of this Contract, and the Authority shall continue to provide Water Service to such Member Governments in accordance with the terms hereof.

(C) Exclusive Remedy. Other than as provided herein, the Authority and the Member Governments hereby establish binding arbitration, as described in this Section 19, as the sole and exclusive method of resolving the disputes arising hereunder which are subject to arbitration. It is expressly agreed that no Member Government shall fund the participation of, or provide in-kind contributions to, any third-party in an administrative or judicial review of any matter which is the subject of arbitration hereunder; provided, however, that this Section 19(C) shall not apply to the Hillsborough County Environmental Protection Commission while in compliance with the agreement between itself, the Authority and the Member Governments.

(D) Events Not Subject to Arbitration. Other than disputes regarding monetary defaults, disputes regarding Water quality as provided in Exhibit D hereto and disputes regarding fiscal matters arising under this Contract, no other disputes arising hereunder shall be subject to the mandatory arbitration provisions of this Section 19; provided the

parties hereto may avail themselves of such arbitration procedures for other disputes on a voluntary basis.

SECTION 20. AUTHORITY'S SOURCES OF WATER. Subject to any rights a Member Government may have pursuant to the Interlocal Agreement, the Authority may provide Water Service to satisfy its obligations hereunder from any component of its System or such other source deemed appropriate by the Authority and the Authority may use any component of its System or such other source to transport water to the Points of Connection.

SECTION 21. DEFAULT AND REMEDY. (A) Defaults. In the event any of the parties default under any of the terms or provisions of this Contract and such default is not subject to the provisions of Section 19 hereof, the parties may avail themselves of any rights or remedies available under applicable law. Notwithstanding the commission of an act of default by a Member Government under any of the terms or provisions of this Contract, none of the parties hereto shall be relieved from their obligations under the terms of this Contract to provide, receive or pay for timely and sufficient Water Service in accordance with the provisions of this Contract. The parties, however, shall not be assumed to have waived any such default by the continuation of the provision or payment of said Water Services. The parties hereto acknowledge that this Contract may not be terminated except as provided in Section 4 hereof.

(B) Reliance by Holders of Obligations. The parties acknowledge that to finance the acquisition and construction of improvements and expansion of the System, the Authority will issue Obligations from time to time and, by reason of such issuance by the

Authority, it is essential that the Authority be paid in a timely fashion all sums due from Member Governments pursuant to this Contract. In light of the obligations of the Authority to holders of Obligations, and the Authority's reliance on Member Governments' representation and covenant that payment of all sums due to the Authority under the terms of this Contract shall be prompt in their remittal, the parties hereby agree to resolve any disputes over the correct amount of monthly billings in accordance with Section 19 hereof. During the pendency of such dispute resolution proceedings, the Authority agrees to continue to provide Water Service to the Member Governments, and the Member Governments agree to continue to pay in full, as billed, for such service, but subject to the Authority's obligation to refund to the Member Governments any amount collected in excess of the amount ultimately determined to have been proper with interest on such excess amount from the date of payment at the rate then prevailing for investments in the Local Government Surplus Funds Trust Fund.

(C) Failure to Pay Monthly Bills. In the event that a Member Government fails to pay the full amount of a bill for monthly service or for any other amount coming due to the Authority under this Contract within thirty (30) days of receipt of said bill, then such Member Government shall pay interest on the unpaid balance from the original due date to the date of payment at the rate then prevailing for investments in the Local Government Surplus Funds Trust Fund.

(D) Bankruptcy by Member Government. In the event a Member Government becomes insolvent, or voluntary or involuntary bankruptcy proceedings are instituted against such Member Government, or a Member Government becomes unable or fails to

meet its obligations to its creditors as they come due, the Authority shall thereupon become entitled to seek the appointment of a receiver for the revenues of such Member Government's water utility system (but not for the operation of a Member Government's water utility system). In the event a receiver is appointed for the revenues of such Member Government's water utility system in accordance with this Section 21, said receiver shall, subject to orders of the appointing court, have the exclusive right to obtain, collect and deposit or invest all revenues payable to or received by a Member Government from its water customers, to pay to the Authority from such revenues all amounts due or becoming due to the Authority under this Contract, and to make payments under the provisions of resolutions or indentures pertaining to outstanding debt of a Member Government that is secured by the revenues of the water utility system.

The Authority's right to seek the appointment of a receiver under the provisions of this Section 21 shall be subordinate to any right to the appointment of a receiver that may be conferred upon the holders of debt obligations secured by the revenues of a Member Government's water utility system. By virtue of the treatment of amounts due to the Authority under this Contract as operating expenses of a Member Government (except as otherwise provided in Section 18(D) hereof), it is acknowledged that the Authority's right to receive payments hereunder will be prior to the right of the holders of the debt obligations of a Member Governments water utility system. A Member Government shall have the right to contest the appointment of a receiver only in the event that such Member Government is not in default on any payment obligations to the Authority hereunder at the time of the filing of the Authority's petition for the appointment of such a receiver. Such

Member Government shall be entitled to have the receivership discharged at any time upon demonstration to the court that the Authority is current in the payment of all amounts then due and owing to the Authority hereunder and in substantial compliance with the material covenants and agreements of the Member Government hereunder.

(E) Force Majeure. In the event that the performance of this Contract by any party is prevented or interrupted in consequence of any cause strictly beyond the control of such party including, but not limited to, Acts of God; war; national emergency; allocation or other governmental restrictions upon the use or availability of labor or materials; shortages of energy sources or supplies; failure to obtain electricity or telephone service; shortages of raw materials; rationing; civil insurrection, riot, disorder or demonstration; strike; lock out; embargo; flood; tidal wave; fire; explosion; bomb detonation; nuclear fallout; windstorm; hurricane; earthquake; a casualty, disaster or catastrophe; unforeseeable failure or breakdown of pumping, transmission, processing or other facilities; governmental rules, acts, orders, restrictions, regulations or requirements (other than denial of an Environmental Permit); discretionary acts or actions of any government, public, governmental authority, commission, board, agency, agent, official or officer (except for the acts or actions of the Authority or Member Governments or its agents or officers and affecting this Contract or the denial of an Environmental Permit); the enactment of any statute, ordinance, resolution, regulation, rule, ruling or order (other than denial of an Environmental Permit); a decree, judgment or injunction of any court; or the failure to obtain any required permit or governmental approval after making its best efforts to obtain same; said party shall not be liable for such nonperformance, but only for the

duration of or to the extent of said force majeure and only if said party is not directly or indirectly responsible therefor. Any party claiming to be relieved of any duty pursuant to this Section 21 shall give prompt written notice thereof to the other parties. The parties agree, however, to remedy with all reasonable dispatch the cause or causes preventing a party from carrying out its agreement.

SECTION 22. DISPOSITION OF ASSETS UPON TERMINATION OF AUTHORITY. Upon termination of the Authority, all assets and property of the Authority shall be disposed of as provided in Section 6.04 of the Interlocal Agreement.

SECTION 23. APPLICABLE LAW AND VENUE. The laws of the State of Florida shall govern the validity, interpretation, construction and performance of this Contract and venue for any suit involving this Contract shall be in the county where the Authority's principal office is located.

SECTION 24. ASSIGNMENT. No assignment, delegation, transfer or novation of this Contract or any part hereof shall be made unless approved in writing by all parties.

SECTION 25. NOTICES. All notices, demands, requests and other communications hereunder shall be deemed sufficient and properly given, if in writing and delivered in person to the following addresses or sent by certified or registered mail, postage prepaid with return receipt requested, at such addresses; provided, if such notices, demands, requests or other communications are sent by mail, they shall be deemed as given on the third day following such mailing which is not a Saturday, Sunday or a day on which United States mail is not delivered:

- If to the Authority: West Coast Regional Water Supply Authority
2535 Landmark Drive, Suite 211
Clearwater, Florida 33761
Attention: General Manager

- If to Pinellas: Board of County Commissioners
315 Court Street
Clearwater, Florida 34616
Attention: County Administrator

- If to Pasco: Board of County Commissioners
7530 Little Road, Room 340
West Pasco Government Center
New Port Richey, Florida 34654
Attention: County Administrator

- If to Hillsborough: Board of County Commissioners
601 East Kennedy Boulevard, 26th Floor
Tampa, Florida 33602
Attention: County Administrator

- If to St. Petersburg: City of St. Petersburg
One Fourth Street North
St. Petersburg, Florida 33701
Attention: City Administrator

- If to Tampa: City of Tampa
315 East Kennedy Boulevard
Tampa, Florida 33602
Attention: Mayor

- If to New Port Richey: City of New Port Richey
5919 Main Street
New Port Richey, Florida 34652
Attention: City Manager

Any party may, by like notice, designate any further or different addresses to which subsequent notices shall be sent. Any notices hereunder signed on behalf of the notifying party by a duly authorized attorney at law shall be valid and effective to the same extent as if signed on behalf of such party by a duly authorized officer or employee.

SECTION 26. THIRD-PARTY BENEFICIARIES. The Authority, St. Petersburg, Tampa, New Port Richey, Pasco, Pinellas and Hillsborough agree the holders of any Obligations issued by the Authority to finance or refinance the acquisition, construction, improvement, replacement or operation of the Authority's System shall be third-party beneficiaries of this Contract and the rights, obligations, representations and warranties of the Authority, Hillsborough, New Port Richey, Pasco, Pinellas, St. Petersburg and Tampa pursuant to this Contract and the Interlocal Agreement. No right or cause of action shall accrue upon or by reason hereof, or for the benefit of any other person not expressly named as a party in this Contract.

SECTION 27. WAIVER. Unless otherwise specifically provided by the terms of this Contract, no delay or failure to exercise a right resulting from any breach of this Contract shall impair such right or shall be construed to be a waiver thereof, but such right may be exercised from time to time and as often as may be deemed expedient. Any waiver shall be in writing and signed by the party granting such waiver. If any representation, warranty or covenant contained in this Contract is breached by any party and thereafter waived by another party, such waiver shall be limited to the particular breach so waived and shall not be deemed to waive, either expressly or impliedly, any other breach under this Contract.

SECTION 28. CAPTIONS AND REFERENCES. The title page, table of contents, section headings and captions contained herein are included for convenience of reference only and shall not be considered part of this Contract or affect in any manner

its construction or interpretation. Except as otherwise indicated, all references herein to sections are to sections of this Contract.

SECTION 29. SEVERABILITY. In the event that any provision of this Contract shall, for any reason, be determined invalid, illegal or unenforceable in any respect, the parties hereto shall negotiate in good faith and agree to such amendments, modifications or supplements of this Contract or such other appropriate actions as shall, to the maximum extent practicable in light of such determination, implement and give effect to the intentions of the parties as reflected herein, and the other provisions of this Contract, as amended, modified, supplemented or otherwise affected by such action, shall remain in full force and effect.

SECTION 30. AMENDMENT. This Contract may only be amended by a written document duly executed by the Authority, Hillsborough, New Port Richey, Pasco, Pinellas, St. Petersburg and Tampa. The parties hereto agree to make no amendment hereto or to the Interlocal Agreement which will materially adversely affect the rights or security of the holders of the Obligations.

SECTION 31. NO OTHER AGREEMENTS. This Contract shall constitute the entire agreement of the Authority, Hillsborough, New Port Richey, Pasco, Pinellas, St. Petersburg and Tampa with respect to the matters provided herein.

SECTION 32. EXISTING AGREEMENTS. The agreements for the supply of water by the Authority to a Member Government described in Exhibit G hereto shall be terminated and shall no longer be in effect upon the Effective Date hereof. The agreements described in Exhibit H hereto shall remain in full force and effect. The parties

hereto agree to modify the agreements described in Exhibit I as specified therein and further agree that the agreements described in Exhibit I shall be superseded to the extent they are not expressly modified. The agreements described in Exhibit J hereto shall be superseded to the extent of any conflict or inconsistency with the Interlocal Agreement or this Contract. Any other agreement of the Authority or Member Government relating to Water production, transmission, treatment, delivery or sale not specifically described in Exhibit G, H, I or J shall be superseded by the Interlocal Agreement and this Contract to the extent of any conflict or inconsistency with such Agreement or this Contract.

SECTION 33. SUCCESSORS AND ASSIGNS. This Contract shall be binding upon and inure to the benefit of the respective successors, permitted assigns, administrators and trustees of the Authority, Hillsborough, New Port Richey, Pasco, Pinellas, St. Petersburg and Tampa.

SECTION 34. EXECUTION OF DOCUMENTS. This Contract shall be executed in multiple duplicate originals, any of which shall be regarded for all purposes as an original and all of which shall constitute one and the same instrument.

SECTION 35. INTERLOCAL AGREEMENT. This Contract shall constitute an interlocal agreement pursuant to Section 163.01, Florida Statutes. A true and correct copy of this Contract and any subsequent amendments shall be filed with the Clerk of the Circuit Court in Pinellas, Pasco and Hillsborough Counties.

SECTION 36. OBLIGATIONS OF MEMBER GOVERNMENTS. All monetary and fiscal obligations of a Member Government arising under this Contract shall be payable solely as described in Section 18(D) hereof.

SECTION 37. CONFLICT WITH INTERLOCAL AGREEMENT. To the extent any provision herein shall conflict with a provision in the Interlocal Agreement, the provision in the Interlocal Agreement shall be controlling.

SECTION 38. GOOD FAITH. The parties hereto agree to exercise good faith and fair dealing in respect to all matters relating to this Contract.

SECTION 39. MISCELLANEOUS PROVISIONS. (A) Whenever the singular is used in this Contract and when required by the context, the same shall include the plural, and the masculine, feminine and neuter genders shall each include the others.

(B) Whenever approvals of any nature are required by any of the parties to this Contract, it is agreed that same shall not be unreasonably withheld, delayed or conditioned, unless the Contract indicates that said approval is within the discretion of one of the parties. Said approval shall promptly be communicated to the requesting party not more than sixty (60) days after its request (or, as to those provisions in this Contract expressly requiring action within a shorter period, then within such period). In the event that the party being called upon for the approval fails to either approve, deny or approve with conditions within said sixty (60) day period (or such shorter period), the request made to the delaying party shall be deemed to be automatically approved, without any further action or notice required by either party, unless the delaying party shall have requested an extension of time for good cause prior to the expiration of the sixty (60) day period (or such shorter period).

(C) It is agreed by and between the parties hereto that all words, terms and conditions contained herein are to be read in concert, each with the other, and that a

provision contained under one heading may be considered to be equally applicable under another in the interpretation of this Contract.

(D) Failure to insist upon the strict compliance of any of the terms, covenants, or conditions hereof shall not be deemed a waiver of such terms, covenants, or conditions, nor shall any waiver or relinquishment of any right or power hereunder at any one time, or times, be deemed a waiver or relinquishment of such right or power at any other time or times or of any other right or power.

IN WITNESS WHEREOF, the Chairman of the West Coast Regional Water Supply Authority has caused this Agreement to be executed and delivered as of the day and year first above written.

ATTEST:

Jerry L. Maxwell
Jerry L. Maxwell, Secretary

WEST COAST REGIONAL WATER
SUPPLY AUTHORITY

By: *Ed Turanchik*
Ed Turanchik, Chairman

David J. Fischer
David J. Fischer, Vice Chairman

Ed Collins
Ed Collins, Director

Steven M. Seibert
Steven M. Seibert, Director

R. Michael Salmon
R. Michael Salmon, Director

Frank Parker
Frank Parker, Director

Date: 6-10-98

(SEAL)

APPROVED AS TO FORM:

Donald D. Conn
Donald D. Conn, General Counsel

[Signature]
WCRWSA Special Counsel

[Signature]



STATE OF FLORIDA
COUNTY OF PINELLAS

The foregoing instrument was acknowledged before me this 10th day of June, 1998, by Ed Turanchik, as Chairman for the West Coast Regional Water Supply Authority.

Krista R. Simon
Notary Public

Print Name



KRISTA R. SIMON
COMMISSION # CC 490328
EXPIRES AUG 21, 1999
BONDED THRU
ATLANTIC BONDING CO., INC.

My Commission Expires:

Personally Known OR Produced Identification
Type of Identification Produced _____

IN WITNESS WHEREOF, the Board of County Commissioners of Hillsborough County, Florida, has caused this Agreement to be executed and delivered as of the day and year first above written.

ATTEST:
RICHARD AKE
CLERK OF THE CIRCUIT COURT

HILLSBOROUGH COUNTY, FLORIDA

[Signature]
Deputy Clerk

By: [Signature]
Chairman

Date: 6-10-98

APPROVED AS TO FORM.

(SEAL)

[Signature]
Office of the County Attorney

STATE OF FLORIDA
COUNTY OF HILLSBOROUGH

The foregoing instrument was acknowledged before me this 10th day of June, 1998, by Thomas Scott as Chairman for the Hillsborough County Commission.

[Signature]
Notary Public

Print Name KRISTA R. SIMON
My Commission Expires: COMMISSION # CC 490929
EXPIRES AUG 21, 1999
BONDED THRU ATLANTIC BONDING CO., INC.

Personally Known OR Produced Identification
Type of Identification Produced _____

IN WITNESS WHEREOF, the Board of County Commissioners of Pasco County, Florida, has caused this Agreement to be executed and delivered as of the day and year first above written.

ATTEST:

PASCO COUNTY, FLORIDA

Julia Porpast
Deputy Clerk

By: Julia Young
Chairman
Date: 6-10-98

APPROVED AS TO FORM:

(SEAL)

Richard J. Reeves
Office of the County Attorney

IN WITNESS WHEREOF, the Board of County Commissioners of Pinellas County, Florida, has caused this Agreement to be executed and delivered as of the day and year first above written.

ATTEST:
KARLEEN F. DE BLAKER
CLERK OF THE CIRCUIT COURT

PINELLAS COUNTY, FLORIDA

Karleen F. De Blaker
Deputy Clerk

By: Barbara Sheen Todd
Chairman

Date: 6-10-98

APPROVED AS TO FORM:

(SEAL)

Joseph M. Manning
Office of the County Attorney

STATE OF FLORIDA
COUNTY OF PINELLAS

The foregoing instrument was acknowledged before me this 10th day of June, 1998, by Barbara Sheen Todd, as Chairman for Pinellas County, Board of County Commissioners.

Krista R. Simon
Notary Public

Print Name _____
KRISTA R. SIMON
COMMISSION # CC 490323
EXPIRES AUG 21, 1999
BONDED THRU
ATLANTIC BONDING CO., INC.

My Commission Expires:

Personally Known ✓ OR Produced Identification _____
Type of Identification Produced _____

IN WITNESS WHEREOF, the City Council of the City of New Port Richey, Florida,
has caused this Agreement to be executed and delivered as of the day and year first
above written.

ATTEST:

CITY OF NEW PORT RICHEY, FLORIDA

Jane Botner
City Clerk

By: *Peter A. Altman*
Mayor

APPROVED AS TO FORM:

(SEAL)

Thomas E. Meers
Office of the City Attorney

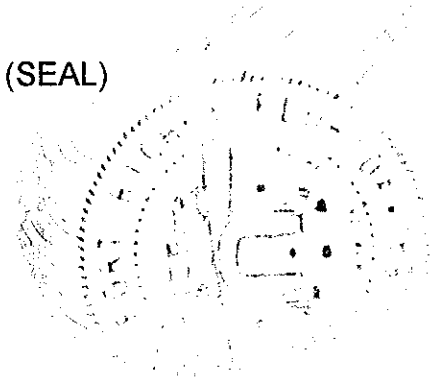

STATE OF FLORIDA
COUNTY OF PASCO

The foregoing instrument was acknowledged before me this 10th day of
June, 1998, by Peter A. Altman, as Mayor for the City of New Port
Richey.

Krista R. Simon
Notary Public

Print Name KRISTA R. SIMON
My Commission Expires: COMMISSION # CC 490323
EXPIRES AUG 21, 1999
BONDED THRU
ATLANTIC BONDING CO., INC.

Personally Known ✓ OR Produced Identification _____
Type of Identification Produced _____

IN WITNESS WHEREOF, the City Council of the City of St. Petersburg, Florida, has caused this Agreement to be executed and delivered as of the day and year first above written.

ATTEST:

CITY OF ST. PETERSBURG, FLORIDA

James K. Brown
City Clerk

By: David S. Fischer
Mayor

APPROVED AS TO FORM:

(SEAL)

[Signature]
Office of the City Attorney

STATE OF FLORIDA
COUNTY OF PINELLAS

The foregoing instrument was acknowledged before me this 10th day of June, 1998, by David S. Fischer, as Mayor for the City of St. Petersburg.

Krista P. Simon
Notary Public

Print Name _____
My Commission Expires _____
KRISTA P. SIMON
COMMISSION # CC 480323
EXPIRES AUG 21, 1999
BONDED THRU
ATLANTIC BONDING CO., INC.

Personally Known ✓ OR Produced Identification _____
Type of Identification Produced _____

IN WITNESS WHEREOF, the City Council of the City of Tampa, Florida, has caused this Agreement to be executed and delivered as of the day and year first above written.

ATTEST:

CITY OF TAMPA, FLORIDA

Janett S. Martin
City Clerk

By: [Signature]
Mayor

APPROVED AS TO FORM:

(SEAL)

[Signature]
Office of the City Attorney

STATE OF FLORIDA
COUNTY OF HILLSBOROUGH

The foregoing instrument was acknowledged before me this 10th day of June, 1998, by Dick Greco, as Mayor of the City of Tampa.

Krista R. Simon
Notary Public

Print Name

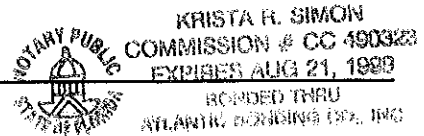

My Commission Expires:

Personally Known OR Produced Identification _____
Type of Identification Produced _____

EXHIBIT A

AUTHORITY'S SYSTEM

EXHIBIT A
AUTHORITY'S SYSTEM
(General Description)
MARCH 23, 1998

EXISTING AUTHORITY ASSETS
TO REMAIN IN AUTHORITY SYSTEM

Cypress Creek Wellfield and Transmission Main – 13 production wells located on 4800 acres in Central Pasco County, of which 3500 acres are owned by SWFWMD, with wellsites licensed to Authority, and 1300 additional acres owned by Authority. Includes six miles of collector and transmission mains 16 inch through 42 inch diameter; associated monitoring wells, and all equipment related thereto.

Cypress Creek Water Treatment Plant – 110 MGD pumping station, chlorination and pH adjustment facilities, 2 - 5 MG water storage tanks, standby emergency electric diesel generators, analytical laboratory, warehouses, administration and maintenance offices, located on 40 acre site licensed from SWFWMD.

Cross Bar Ranch Wellfield and Transmission Main – 17 production wells located on wellsites owned by the Authority in Northern Central Pasco County on property owned by Pinellas County. Includes 20 miles of collector and transmission mains 16 inch through 60 inch diameter, associated monitoring wells; and all equipment related thereto.

Cypress Creek Transmission Main – Includes 19 miles of transmission main 64 through 84 inches in diameter.

U. S. 41 Booster Station – 5 MGD booster facility located on 5 acre site owned by the Authority in Central Pasco County.

West Pasco Booster Station - 3 MGD booster facility located on 1 acre Authority easement in West Pasco County.

Odessa Intertie – 3 MGD meter facility on a 3 acre sites owned by the Authority in West Pasco County.

Morris Bridge Booster Station and Transmission Main – 30 MGD booster facility on 3 acre site licensed to the Authority by the City of Tampa. Includes 5 MG water storage tank and 4 miles of 64 inch diameter transmission main.

Cypress Bridge Wellfield and Transmission Main – 10 production wells located on six (1 to 4 acre) individual sites in Southern Pasco and four - 4 acre individual sites in Northern Hillsborough County, all sites owned by Authority or licensed to Authority. Includes 20 miles of collector and transmission mains 16 inch through 64 inches in diameter, associated monitoring wells; and all equipment related thereto.

Lake Bridge Water Treatment Plant – 5 MGD pumping station, chlorination and pH adjustment facilities, 2-150,000 gallon water storage tanks, located on a 50 acre site owned by the Authority in Northern Hillsborough County.

Northwest Hillsborough Regional Wellfield and Transmission Main – Seven production wells on individual one acre wellsites owned by or licensed to the Authority in Northwest Hillsborough County. Includes 8 miles of collector and transmission mains 12 through 36 inches in diameter, associated monitoring wells; and all equipment related thereto.

Sheldon Road Transmission Main – 1-1/2 miles of 30 inch transmission main in Northwest Hillsborough County.

South Central Hillsborough Regional Wellfield and Transmission Main – 17 production wells on individual 1-4 acre wellsites owned by or licensed to the Authority in Southern Hillsborough County. Includes 19 miles of collector and transmission mains 16 inches through 54 inches in diameter, associated monitoring wells; and all equipment related thereto.

Tampa Bypass Canal Pumping Station – 40 MGD lift station location on the Harney Canal in Hillsborough County on a site licensed by SWFWMD. Includes a 42 inch transmission main, associated monitoring wells; and all equipment related thereto.

Starkey Wellfield – 14 production wells on 8,000 acres owned by SWFWMD in Western Pasco County on wellsites licensed to the Authority by SWFWMD. Includes 8 miles of collector and transmission mains 6 inches through 42 inches in diameter, associated monitoring wells; and all equipment related thereto.

North Pasco Wellfield – Two active production wells, and a total of six sites on one acre sites in western Pasco County on land licensed to the Authority by Pasco County. Includes 4 miles of collector and transmission mains 16 inches through 36 inches in diameter, associated monitoring wells; and all equipment related thereto.

Tampa/Hillsborough Interconnect Booster Station – 1 MGD booster pump station adjacent to North Boulevard in NW Hillsborough County.

AUTHORITY ASSETS IN PROPERTY ACQUISITION OR CONSTRUCTION PHASE TO REMAIN IN AUTHORITY SYSTEM

Cypress Bridge and Morris Bridge Access Roads – Wetland crossing improvements along 17 mile transmission main corridor in Central Pasco and Northern Hillsborough Counties.

Cypress Creek Water Treatment Plant Electrical – 2400 volt switchgear replacement and lightning protection improvements.

Cypress Creek Transmission Main Replacement – Replacement of 8 miles of 84 and 66 inch pipe manufactured by Interpace.

Keller Transmission Main – Replacement of 1.5 miles of 42 and 54 inch pipe manufactured by Interpace.

Tampa/Hillsborough Interconnect Booster Station – New 10 MGD booster facility on site adjacent to North Boulevard in NW Hillsborough County.

Cosme Transmission Main – 8 miles of 48 through 72 inch diameter transmission main.

**EXISTING AUTHORITY ASSETS TO BE TRANSFERRED
BY AUTHORITY TO MEMBERS**

West Pasco Transmission Main (to Pasco County) – Includes 3-1/2 miles of 16 inch through 24 inch diameter transmission main to be transferred to Pasco County.

Lithia WTP and South County Transmission Mains (to Hillsborough County) – 45 MGD pumping station and chlorination facilities. Includes 2 – 5 MG water storage tanks, emergency electric diesel generators, analytical laboratory, warehouse, administration and maintenance offices, located on a 40 acre site owned by Hillsborough County in Southern part of County. Includes 22 miles of transmission mains 24 inches through 42 inches in diameter.

Gardinier Interconnect (to Hillsborough County) – 6 MGD interconnect facility in Southern Hillsborough County.

Tampa/Hillsborough Interconnect Transmission Main (to Hillsborough County and City of Tampa) – 1-1/2 miles of 30 inch transmission main, from Authority to City of Tampa and Hillsborough County.

MEMBER ASSETS TO BE TRANSFERRED BY MEMBERS TO AUTHORITY

Hillsborough County Dispersed Wells - 8 production wells (consisting of The Crippenwood, Manors of Crystal Lake (2), Eagles (2), Truman, Bloomingdale and Highview wells) located on individual sites at various locations owned by Hillsborough County, plus two additional existing interconnect meters between Hillsborough County and the City of Tampa, and two interconnect meters between Hillsborough County and the City of Temple Terrace; and all equipment related thereto.

Cosme/Odessa Wellfield – 23 production wells and monitor wells in Northwest Hillsborough County on land owned by City of St. Petersburg. Includes 5 miles of collector and transmission mains 6 inches through 36 inches in diameter and water treatment plant influent flowmeter; and all equipment related thereto.

Section 21 Wellfield – 6 production wells and monitor wells in Northwest Hillsborough County on land owned by City of St. Petersburg. Includes 3 miles of collector and transmission mains 12 inches through 36 inches in diameter; and all equipment related thereto.

South Pasco Wellfield – 8 production wells and monitor wells in southern Pasco County on land owned by City of St. Petersburg; and all equipment related thereto.

St. Petersburg Transmission Main – 12 miles of 42 inch diameter transmission main located in Southern Pasco and Northwest Hillsborough Counties; and all equipment related thereto.

Eldridge – Wilde Wellfield – 58 production wells and monitor wells located in Northeastern Pinellas and Northwest Hillsborough Counties on lands owned or controlled by Pinellas County. Includes all collector piping and water treatment plant influent flowmeter; and all equipment related thereto.

Morris Bridge Wellfield – Includes 20 production wells, monitor wells, and 8 miles of collector and transmission mains; and all equipment related thereto.

EXHIBIT B

MASTER WATER PLAN

MASTER WATER PLAN

The Master Water Plan, as approved by the Authority's Board of Directors in December 1995, comprised the development of 85 mgd of new supply and three pipeline interties in two phases. Further evaluation of three developmental alternatives and a conservation program to save 17 mgd over the 10 year development period have reinforced the Plan. The Master Water Plan currently includes the following potential new supply projects, as may be subsequently modified by the Authority Board pursuant to the permitting procedures established in the Interlocal Agreement:

Cypress Bridge Permit Increase – Ongoing evaluation of operating and monitoring data for the Cypress Bridge Wellfield, which straddles Hillsborough and Pasco Counties, for potential incremental increase in production above current permitted capacity.

Tampa Bypass Canal – Project looks to utilize available supply from the Tampa Bypass Canal beyond that which is committed as augmentation to the City of Tampa Hillsborough River Reservoir. A component of the Enhanced Surface Water System.

Industrial/Agricultural Exchange/Alafia River – Proposes to capture seasonally variable available flows from the Alafia River and Lithia Springs for storage in an off-stream reservoir. A component of the Enhanced Surface Water System.

Hillsborough River High Water – Proposes to harvest a portion of wet-season flows in the Hillsborough River after City of Tampa and downstream ecological needs have been met. A component of the Enhanced Surface Water System.

Enhanced Surface Water System – The previous three supply projects (Tampa Bypass Canal, Industrial/Agricultural Exchange/Alafia River, and Hillsborough River High Water) with the South Central Hillsborough Intertie. The Enhanced Surface Water system realizes greater yields and increased efficiencies over the individual projects through shared conveyance, storage, and treatment facilities.

Brandon Urban Dispersed Wells – Selective redevelopment of groundwater supply in the Brandon area.

Cone Ranch and Dispersed Wells – Project to develop long-planned available groundwater supply in Northeast Hillsborough County in conjunction with hydrologic restoration.

Hillsborough Bay Resource Exchange – Indirect potable reuse through supplemental treatment of H.F. Curren effluent and subsequent augmentation of Tampa Bypass Canal. Public acceptability currently being evaluated.

Seawater Desalination – Investigation of this supply option through issuance of a request for proposals for privatized development and subsequent evaluation of responses.

Brackish Water Desalination – Continued evaluation by Authority and Member Governments of opportunities for development of brackish water supplies.

Exhibit B is provided for informational purposes only.

EXHIBIT C

POINTS OF CONNECTION

**EXHIBIT C
POINTS OF CONNECTION INFORMATION**

MEMBER	FACILITY SUPPLIED	POINT OF CONNECTION	QUALITY WATER PROPOSED TO BE DELIVERED	CREDIT NEEDED TO OBTAIN QUALITY WATER	ANTICIPATED AMOUNT OF CREDIT \$/1000 GALLONS	DESIGN PRESSURE AT POINT OF CONNECTION	NOTES
Pasco County	U.S. 41 Intertie	Booster Pump Discharge	Yes	No	0	80 psig	
	Odessa Intertie	Flowmeter Outlet	Yes	No	0	50 psig (80 psig upon relocation)	To be relocated by County or combined w/Pasco Intertie Meter
	W. Pasco Intertie	Booster Pump Discharge	Yes	No	0	80 psig	To be relocated by County
	Lake Bridge WTP	HSP Discharge	Yes	No	0	80 psig	
	Little Road WTP	Starkey WF Flowmeter Outlet	No	Yes	\$0.05	Aerator Tray Elevation, Ft.	
Hillsborough County	Lake Park WTP	Plant Inf Flowmeter Outlet	Yes	No	0	40 psig	
	NW Hillsborough PWF	Plant Inf Flowmeter Outlet	No	Yes	\$0.01	40 psig	
	Tampa/Hillsborough Interconnection	Booster Pump discharge	Yes	No	0	80 psig	
	Lithia WTP	Plant Inf Flowmeter Outlet	No	Yes	\$0.05	Aerator Tray Elevation, Ft.	
	Crippenwood	Well Flowmeter Outlet	No	Yes	\$0.05	65 psig	Iron
	Manors of Crystal Lake	Well Flowmeter Outlet	Yes	No	0	70 psig	
	Eagles	Well Flowmeter Outlet	No	Yes	\$0.05	70 psig	
	Truman	Well Flowmeter Outlet	Yes	No	0	40 psig	
	Bloomingtondale	Well Flowmeter Outlet	Yes	No	0	40 psig	
	Highview	Well Flowmeter Outlet	Yes	No	0	70 psig	
	U.S. 41/Progress Village	U.S. 41 from City of Tampa to Hillsborough County	Yes	No	0	50 psig	
	Waters Avenue/UPS	Waters Avenue from City of Tampa to Hillsborough County	Yes	No	0	50 psig	
	U.S. 301/Jefferson Rd.	U.S. 301 from City of Temple Terrace to Hillsborough County	Yes	No	0	50 psig	
	U.S. 301/Williams Rd.	U.S. 301 from City of Temple Terrace to Hillsborough County	Yes	No	0	50 psig	
New Port Richey	Maytum WTP	Plant Inf Flowmeter Outlet	No	Yes	\$0.05	Aerator Tray Elevation, Ft.	

PINELLAS COUNTY FLA.
 OFF. REC. BK 10155 PG 391
 OR BK 3967 PG 626
 195 of 1055

PAGE 2 (CONT) EXHIBIT C - POINTS OF CONNECTION INFORMATION

MEMBER	FACILITY SUPPLIED	POINT OF CONNECTION	QUALITY WATER PROPOSED TO BE DELIVERED	CREDIT NEEDED TO OBTAIN QUALITY WATER	ANTICIPATED AMOUNT OF CREDIT \$/1000 GALLONS	DESIGN PRESSURE AT POINT OF CONNECTION	NOTES
Pinellas County	S.K. Keller WTP - from Regional System	Flowmeter Outlets (54 inch and 42 inch)	Yes	No	0	75 psig	54" meter to be relocated by WCRWSA 42" meter to be eliminated
	S.K. Keller WTP - from Eldridge Wilde WF	Plant Inf Flowmeter Outlet	No	Yes	\$0.05	20 psig	
St. Petersburg	Cosme WTP	Plant Inf Flowmeter Outlet	No	Yes	\$0.01	Aerator Tray Elevation Ft.	To be replaced by WCRWSA
	Cosme WTP	NWHRWF Flowmeter Outlet	No	Yes	\$0.01	Aerator Tray Elevation Ft.	To be deleted upon completion of Cosme TM by WCRWSA
	Cosme WTP	Bypass Flowmeter Outlet	Yes	No	\$0.00	70 psig	To be constructed by WCRWSA
Tampa	Morris Bridge WTP	New Plant Inf Flowmeter Outlet	No	Yes	\$0.05	Treatment Unit Pressure Requirement, psig	To be installed by WCRWSA
	Hillsborough River Reservoir (from Tampa Bypass Canal)	Hillsborough River Reservoir	NA	NA	NA	Reservoir Elevation, Ft.	Not subject to WQ standards

PINELLAS COUNTY FLA.
 OFF. REC. BK 10155 PG 382
 OR BK 3967 PG 627
 196 of 1055

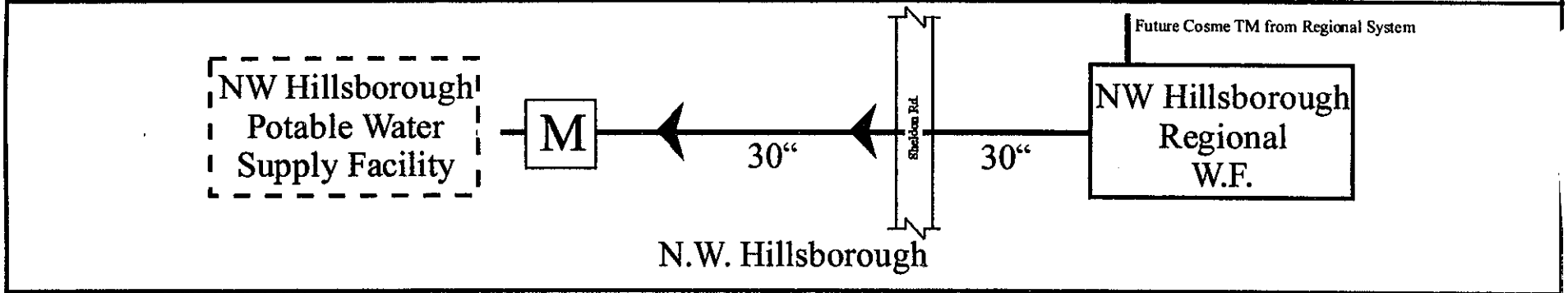
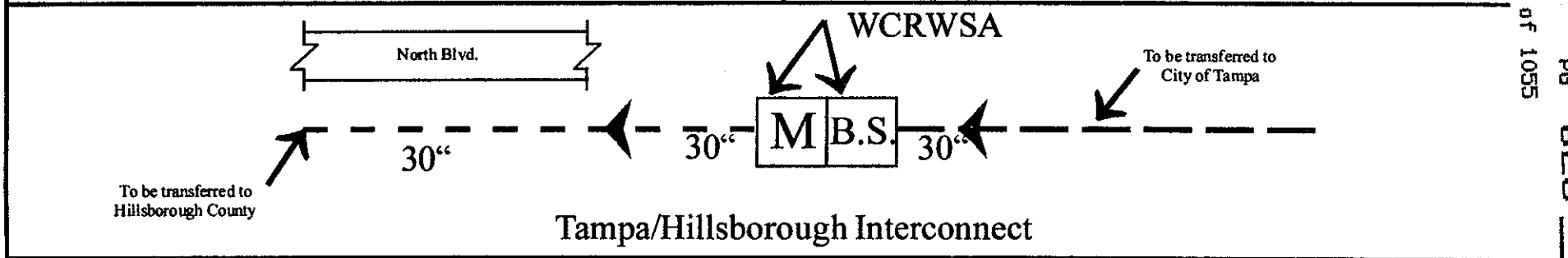
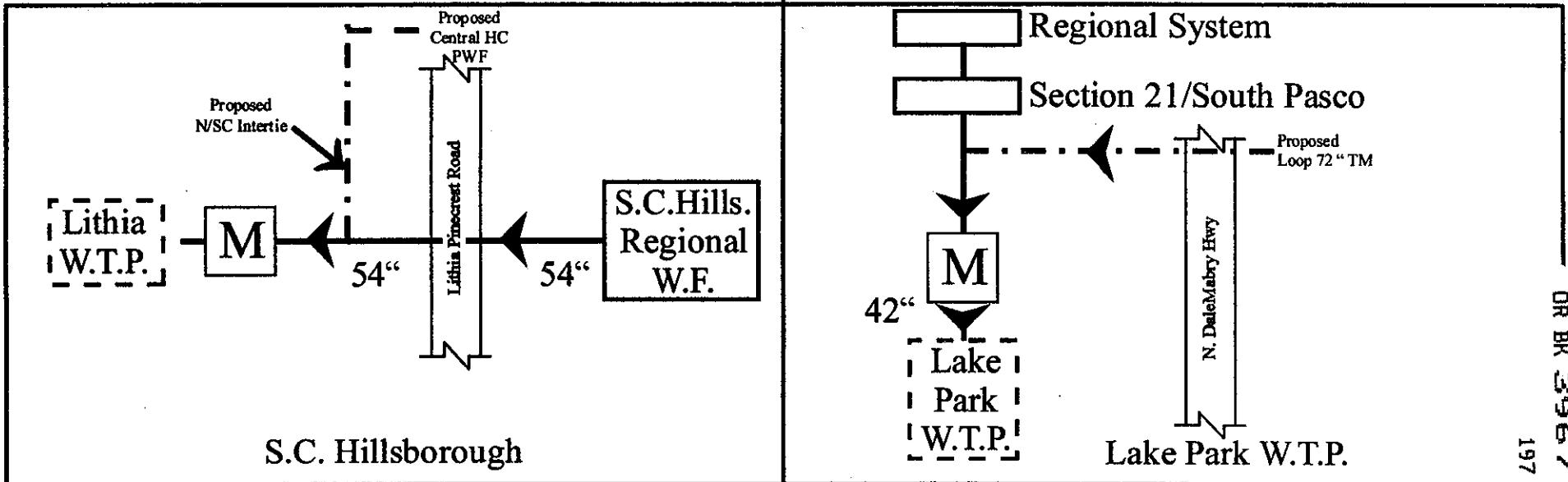



Hillsborough County
Points of Connection

Pg 1 of 2

— WCRWSA

- - - Hillsborough County

— City of Tampa

- . . . Proposed WCRWSA

● Connected Pipes

M Flow Meter

B.S. Booster Station

FILE: o:\cor\Hills\ken herd/HHUCo

DATE: 03/20/98

DRAWN BY: R.L.S.

DR BK 3967 PG 628
 197 of 1055

PINELLAS COUNTY FLA
 OFF. REC. BK 10155 PG 393

DR BOOK 09143 PAGE 0197

6610 51160

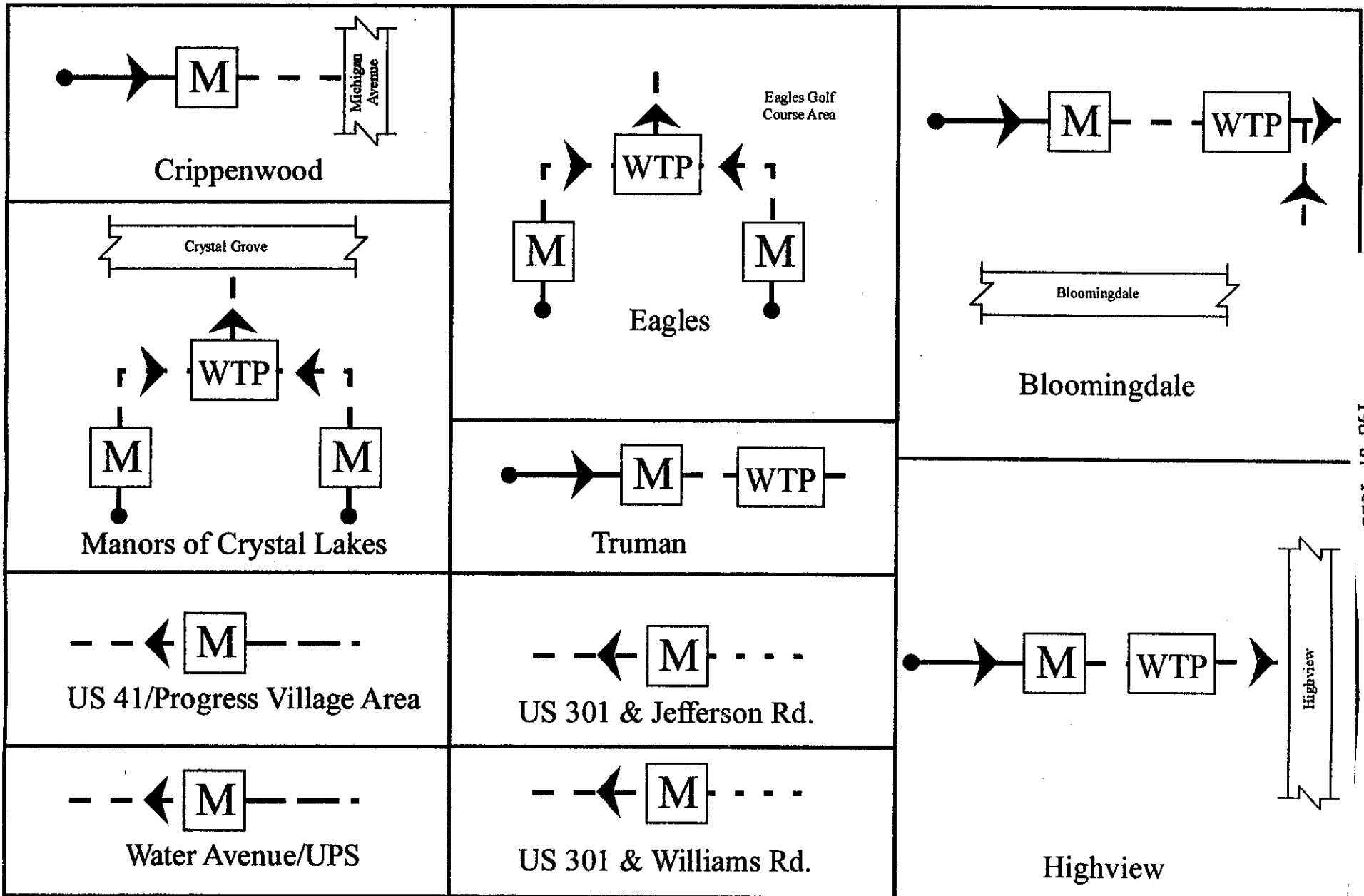

DR BK 3967 PG 629
 198 of 1055
 PINELLAS COUNTY FLA.
 OFF. REC. BK 10155 PG 394

	<h1>Hillsborough County</h1> <h2>Points of Connection</h2>	WCRWSA Hillsborough County City of Tampa City of Temple Terrace Proposed WCRWSA	Connected Pipes Flow Meter	FILE: 020907Res/ken herd/Hills Co/led. DATE: 03/20/98 DRAWN BY: R.L.S.
		DR BOOK 09143 PAGE 0198 Pg 2 of 2		

8610 8/13

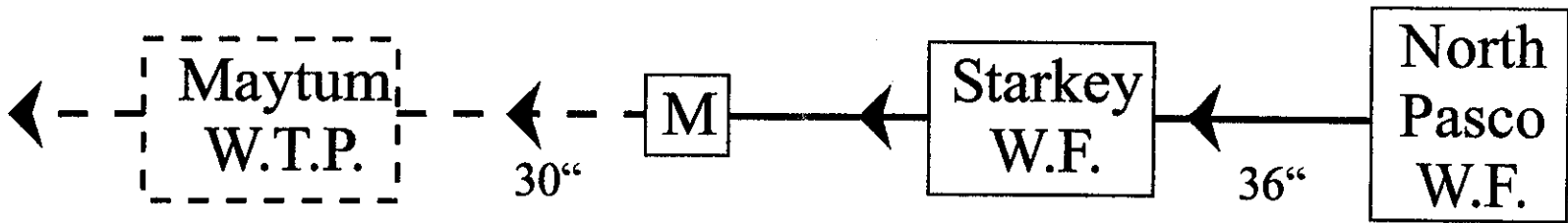
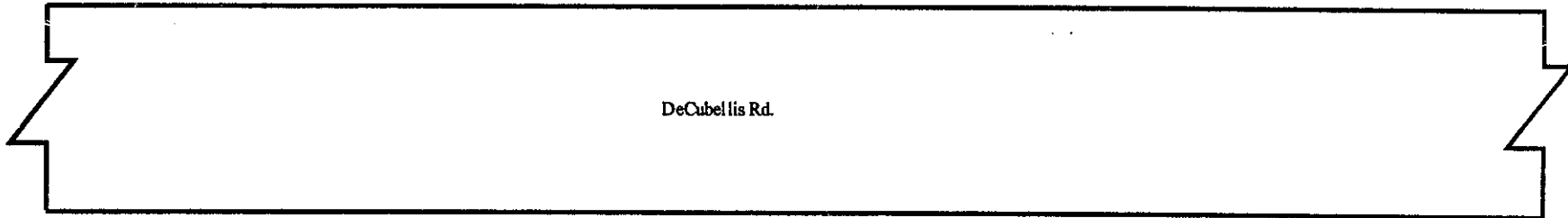

City of New Port Richey Point of Connection

Pg 1 of 1

- WCRWSA
- New Port Richey
- Connected Pipes

Flow Meter

FILE: o:corefiles/ken hard/NPR
DATE: 03/20/98
DRAWN BY: R.L.S.

6610 3967
09143

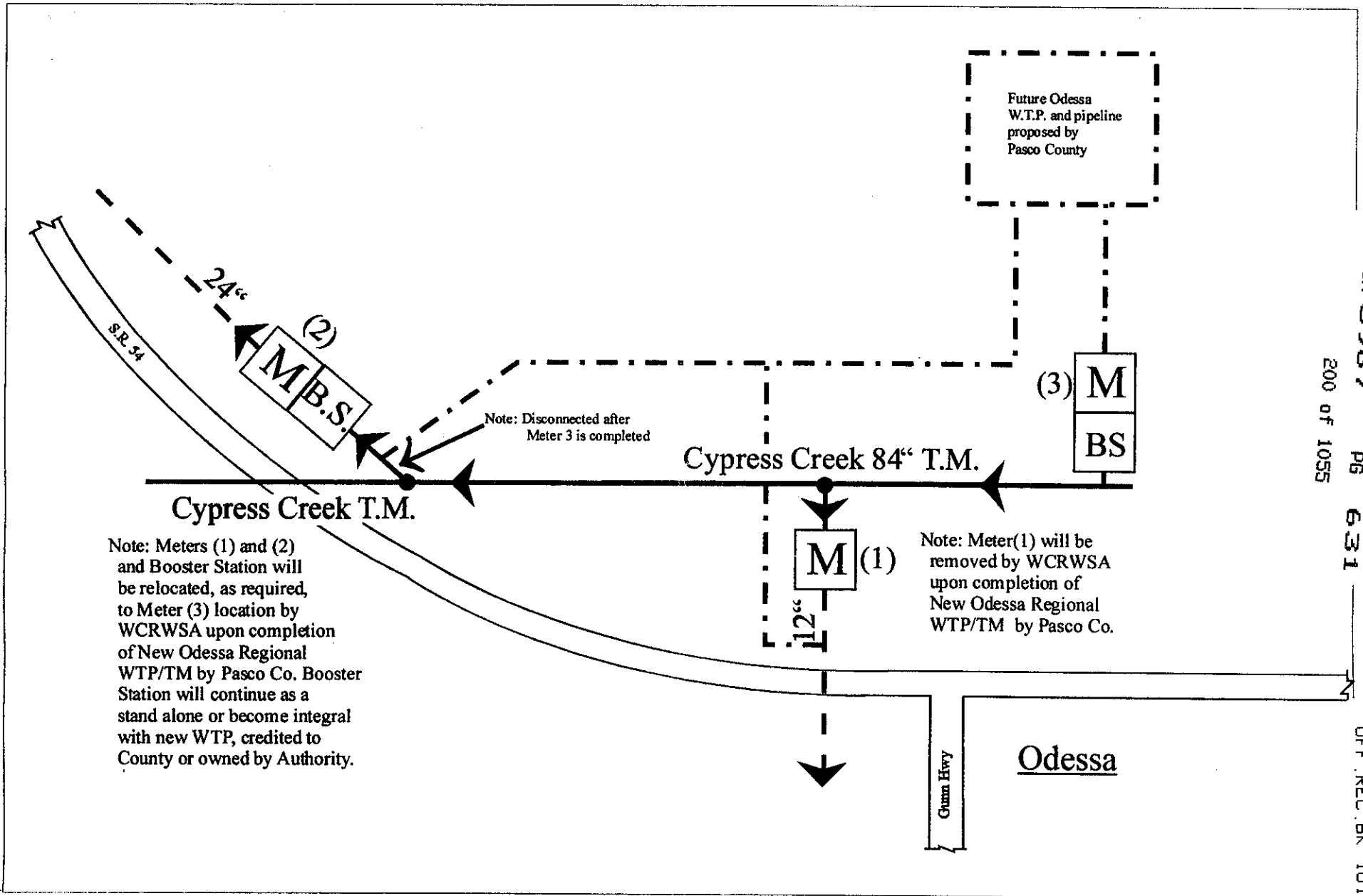

OR BK 3967 PG 631
200 of 1055

PINELLAS COUNTY FLA.
OFF. REC. BK 10155 PG 396

Note: Meters (1) and (2) and Booster Station will be relocated, as required, to Meter (3) location by WCRWSA upon completion of New Odessa Regional WTP/TM by Pasco Co. Booster Station will continue as a stand alone or become integral with new WTP, credited to County or owned by Authority.

Note: Meter(1) will be removed by WCRWSA upon completion of New Odessa Regional WTP/TM by Pasco Co.

Note: Disconnected after Meter 3 is completed



Pasco County Points of Connection

Pg 1 of 3

—	WCRWSA	●	Connected Pipes
- - -	Pasco County	M	Flow Meter
- . - . -	Proposed Pasco County	BS	Booster Station

FILE: o:\corefiles\ken herd\PasCo
DATE: 03/20/98
DRAWN BY: R.L.S.

OR BK 3967 PG 632
201 of 1055

PINELLAS COUNTY FLA.
OFF. REC. BK 10155 PG 397

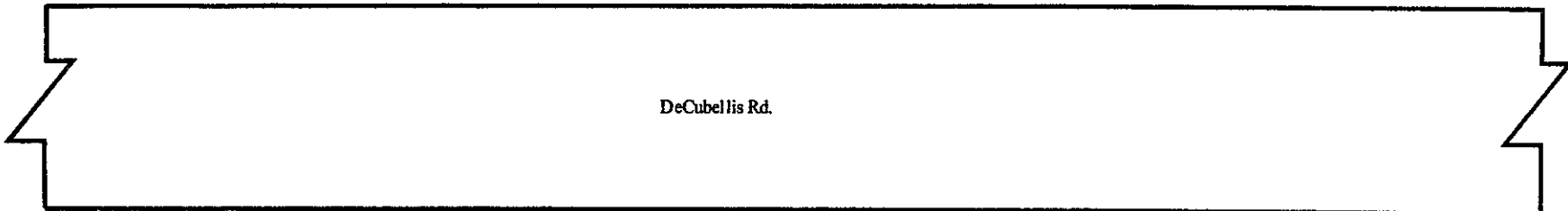
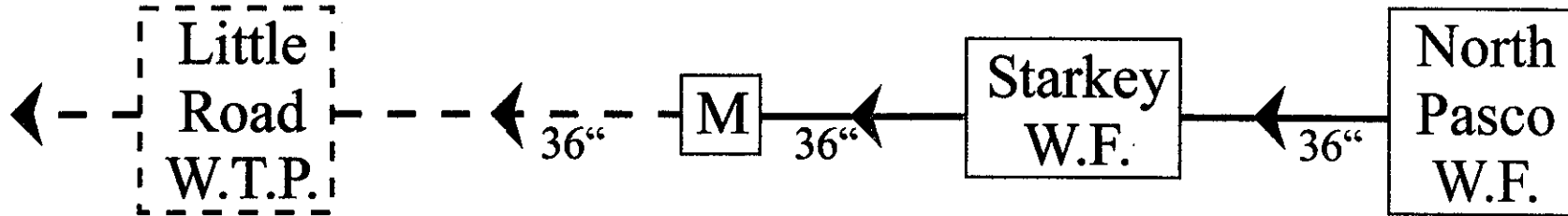

DeCubellis Rd.

 <p>Pasco County Points of Connection</p>	<p>— WCRWSA</p> <p>- - - Pasco County</p> <p>● Connected Pipes</p>	<p>M Flow Meter</p>	<p>FILE: 090901files/ken herd/PasCo2</p> <p>DATE: 03/20/98</p> <p>DRAWN BY: R.L.S.</p>
	<p>Pg 2 of 3</p>		
	<p>OR BOOK 09143 PAGE 0201</p>		

1000 3/1/98

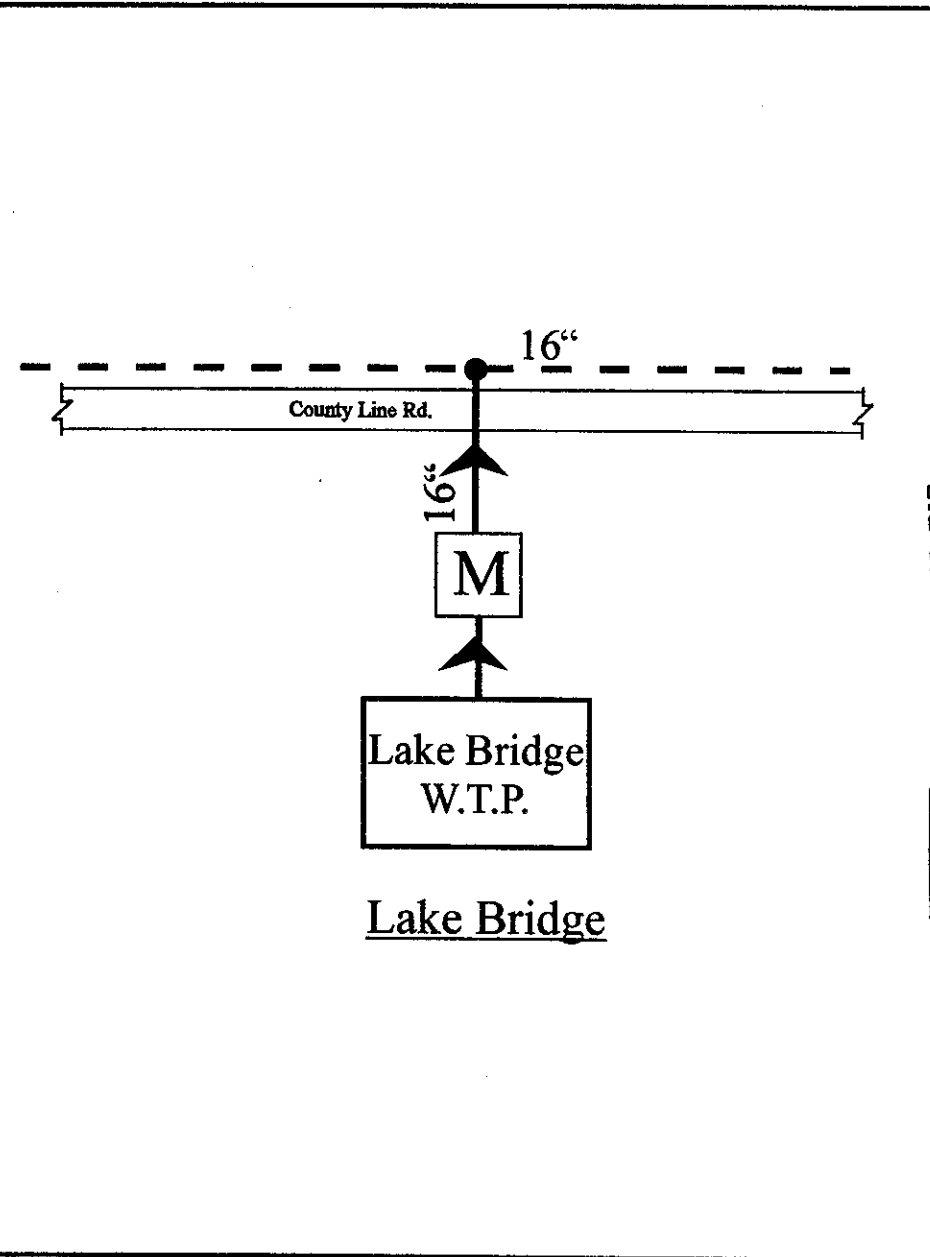
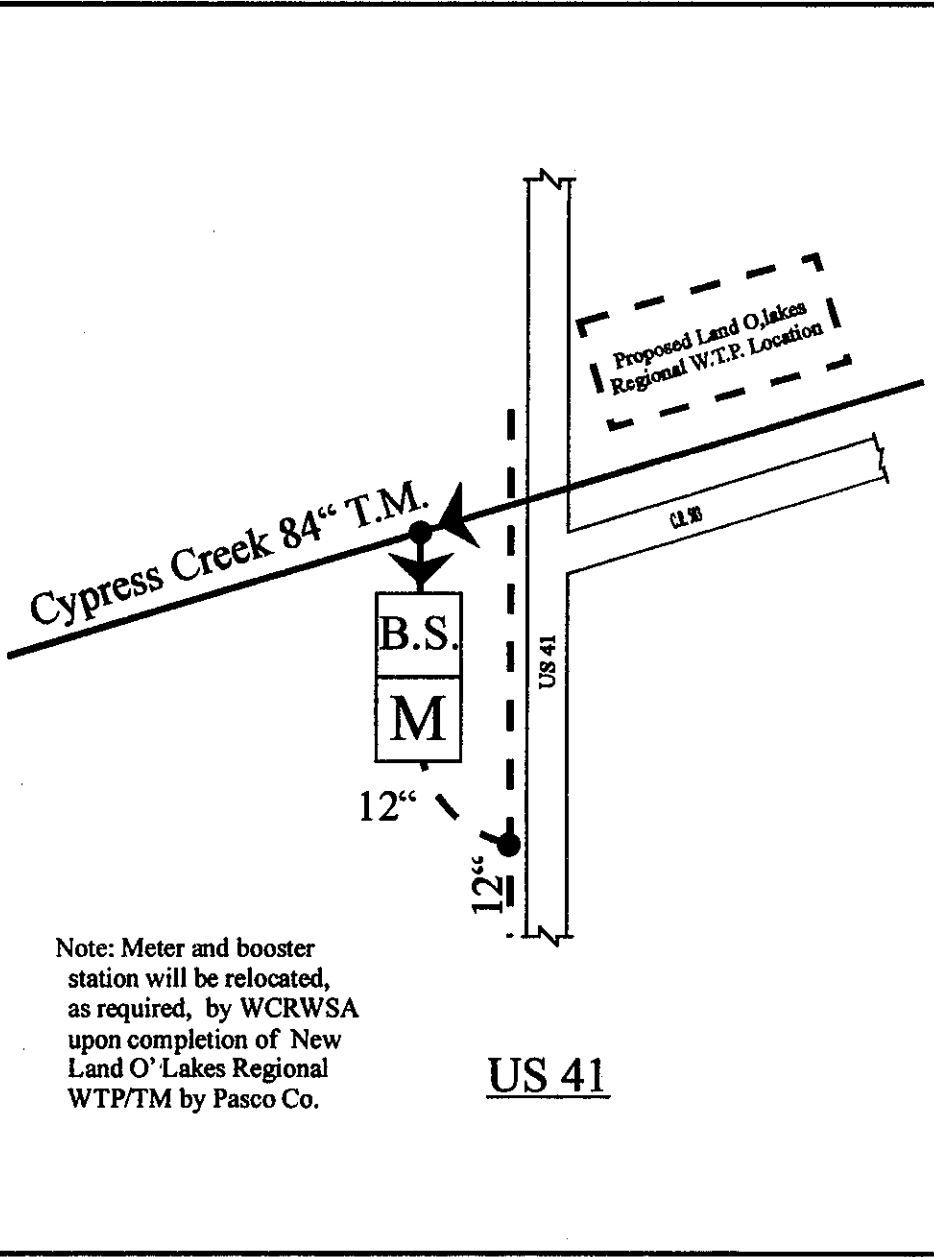

Note: Meter and booster station will be relocated, as required, by WCRWSA upon completion of New Land O' Lakes Regional WTP/TM by Pasco Co.

OR BK 3967 PG 633
 202 of 1055
 PINELLRS COUNTY FLA.
 OFF REC BK 10155 PG 398

Pasco County Points of Connection

Pg 3 of 3

	WCRWSA		Flow Meter
	Pasco County		Booster Station
	Connected Pipes		

FILE: o:\corefiles\ken hord/PasCo
 DATE: 03/20/98
 DRAWN BY: R.L.S.

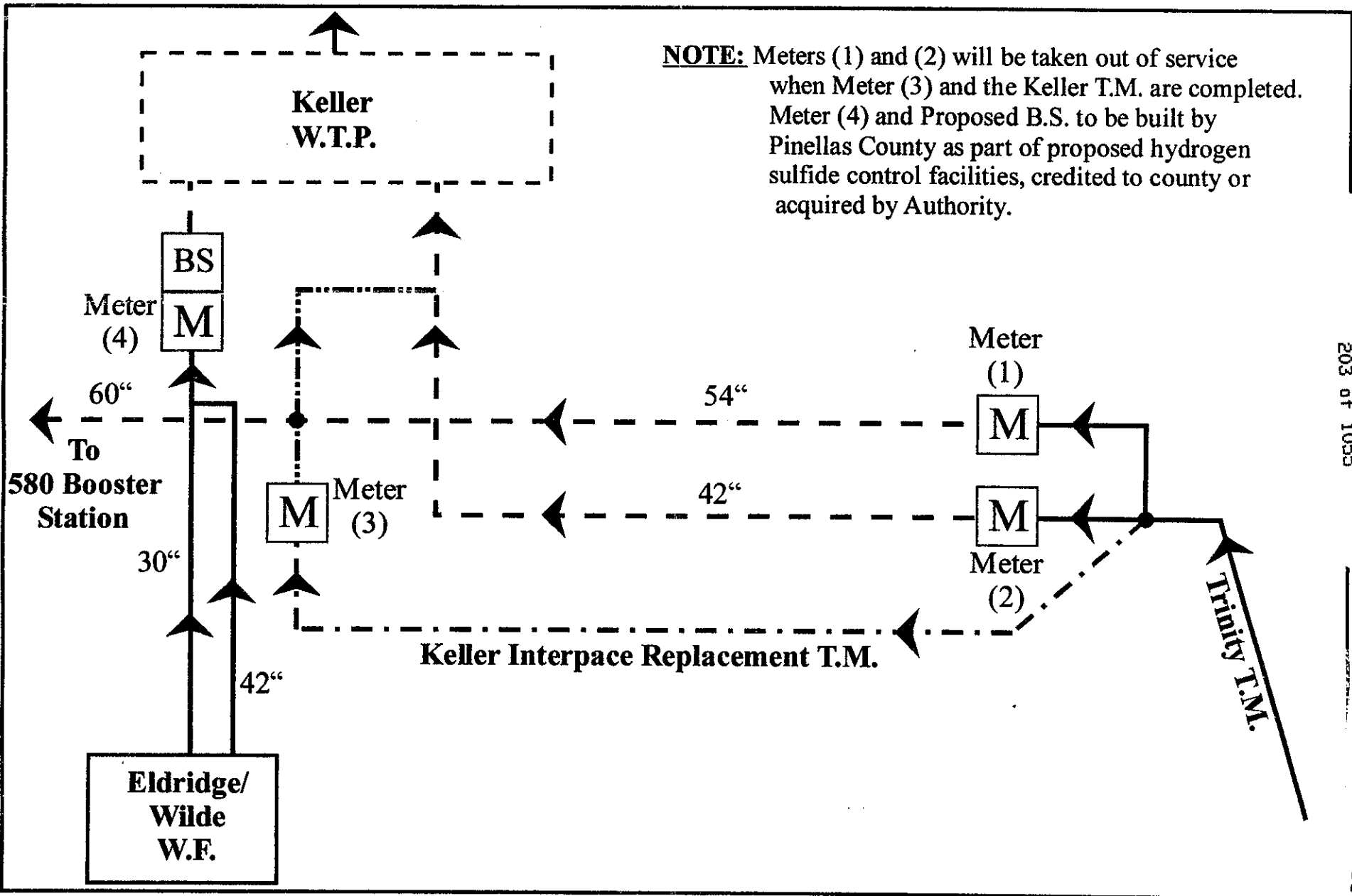

NOTE: Meters (1) and (2) will be taken out of service when Meter (3) and the Keller T.M. are completed. Meter (4) and Proposed B.S. to be built by Pinellas County as part of proposed hydrogen sulfide control facilities, credited to county or acquired by Authority.

DR BK 3967 PG 634 OFF REC BK 10155 PG 399
 PINELLAS COUNTY FLA.



Pinellas County Points of Connection

Pg 1 of 1

- WCRWSA
- - - Pinellas County
- . - . - Proposed WCRWSA
- Proposed built by WCRWSA and owned by Pinellas County
- Connected Pipes
- M Flow Meter
- BS Proposed Booster Station

FILE: o:\corefiles\ken herd\Pine Co
 DATE: 03/20/98
 DRAWN BY: R.L.S.

8090 8110
 DR BK 3967 PG 634 OFF REC BK 10155 PG 399

Cosme T.M.

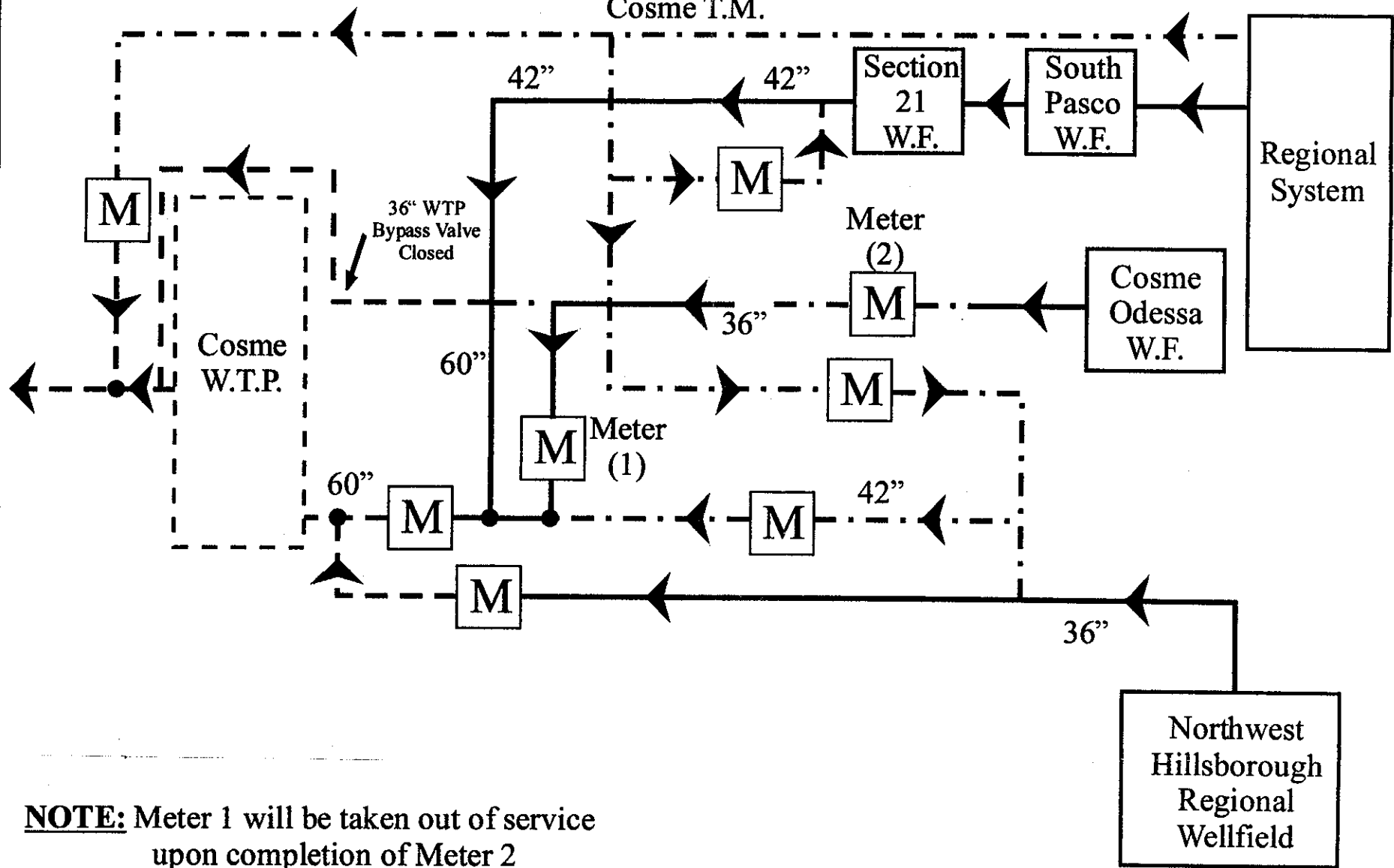

OR BK 3967 PG 635
204 of 1055
PINELLAS COUNTY FLA.
OFF. REC. BK 10155 PG 400

NOTE: Meter 1 will be taken out of service upon completion of Meter 2



City of St. Petersburg Points of Connection

Pg 1 of 1

- WCRWSA
- City of St. Petersburg
- Proposed WCRWSA
- Connected Pipes

FILE: o:\corefiles\ken herd\Cosse1
 DATE: 03/20/98
 DRAWN BY: R.L.S.

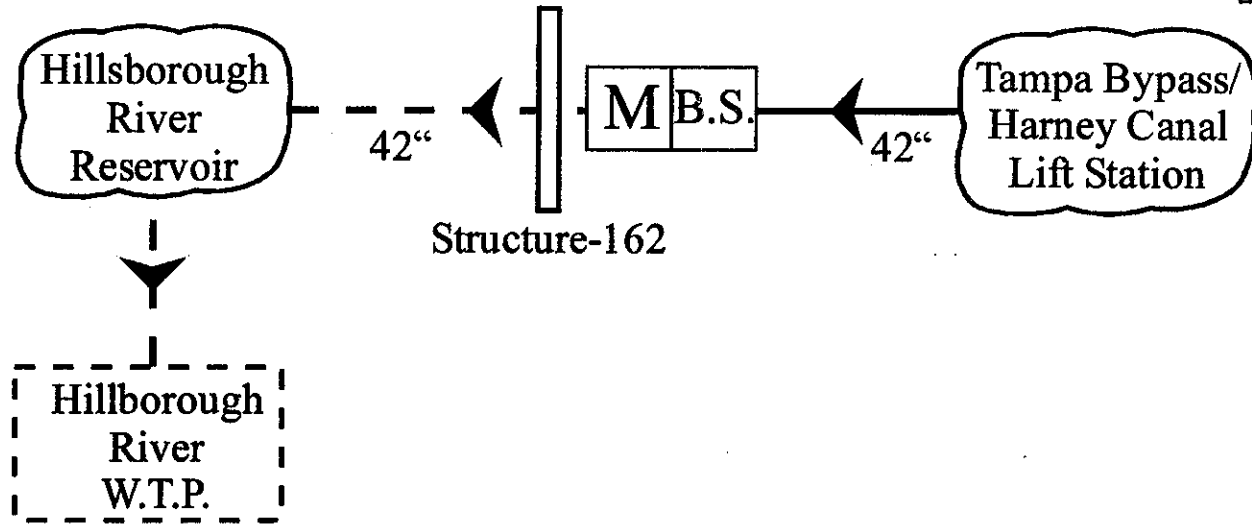

DR BK 3967 PG 636
205 of 1055

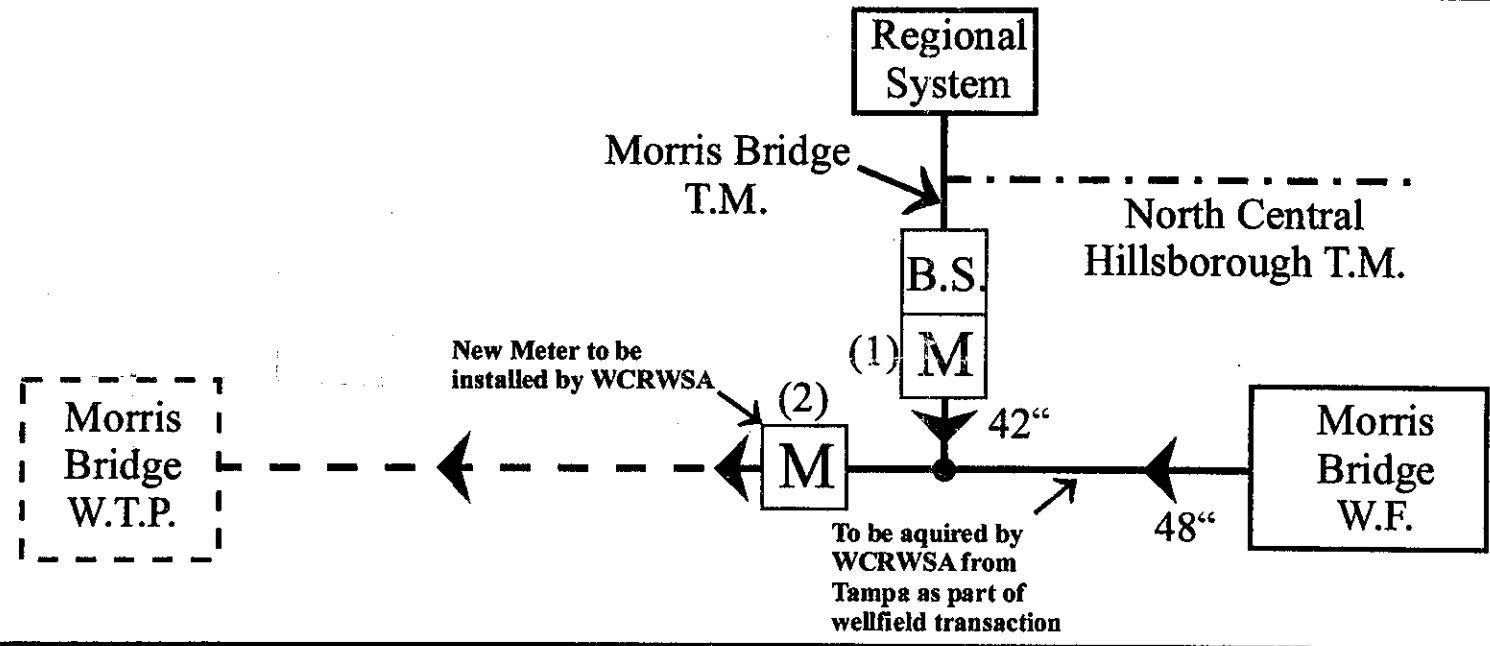

PINELLAS COUNTY FLA.
OFF. REC. BK 10155 PG 401



City of Tampa Points of Connection

- WCRWSA
- - - - - City of Tampa
- Proposed by WCRWSA

- M** Flow Meter
- B.S.** Booster Station
- Connected Pipes

FILE: 0:\core\files\ken herd\CoT
DATE: 03/20/98
DRAWN BY: R.L.S.

EXHIBIT D

SUPPLEMENTAL WATER QUALITY PARAMETERS

EXHIBIT D

SUPPLEMENTAL WATER QUALITY PARAMETERS

Water supplied from the Authority's System shall be sampled annually at a minimum, at the Point(s) of Connection for the following parameters. The Quality Water definition and the supplemental parameters listed below define the water quality to be provided by the Authority:

<u>Contaminant</u>	<u>Goal</u>
Sulfides	0.1 mg/l
Total Hardness	300 mg/l as CaCO ₃
Alkalinity	40 mg/l as CaCO ₃ (minimum value)

Note: Supplemental parameters are not currently included in S.F.D.E.P. 62-550.

The results of the annual sampling program shall be provided to all the Member Governments in a report format. The cost of the annual sampling program shall be borne by the Authority as an Operation, Maintenance and Administrative Cost to be shared equitably among its Members. In the event that the annual sampling program indicates the maximum contaminant level from the table is exceeded for one or more parameter, the Authority shall follow the retesting and mitigative measures currently defined in State and Federal regulations.

Within 60 days of February 23, 1998, or the next following regularly scheduled meeting of the Authority's Board of Directors, the Authority and Member Governments shall propose a list of a minimum of 19 Supplemental Water Quality parameters and assigned levels for Board approval. Such list, when approved by the Board, shall supplement this Exhibit D. Any Member Government that does not concur with the amended list of parameters or their assigned levels, shall be entitled to seek relief by the arbitration process established in Section 19 of the Contract. The standards for the arbitration process shall be:

1. Whether cost-effective alternative water supplies can be developed consistent with Master Water Plan objectives, including diversity of supply sources, and
2. Whether Quality Water delivered by the Authority would not cause a particular Member Government utility to adopt new treatment techniques beyond modified chemical dosages and/or optimization of existing unit processes, to meet a moderately altered source of Quality Water.

In the event that a Member Government requests sampling for additional parameters or an increase in sampling frequency, the cost associated with the sampling will be borne solely by that Member Government and not by the Authority. If scheduling permits, the Authority may provide the sampling services at cost to the Member Government or the Member Government may perform the additional testing.

Sampling shall be conducted in accordance with the procedures defined in the current regulations for the Primary and Secondary Drinking Water Standards and/or according to Standard Methods, latest edition, for those parameters for which testing procedures are not defined in the regulations.

The Authority shall evaluate each new supply element to ensure that:

1. Quality Water is provided that at a minimum, meets all Federal and State drinking water quality standards with the exception of corrosion control and disinfection so as to protect public health and safety and provide water as aesthetically-pleasing as is currently supplied.
2. Individual Member Governments will continue to provide additional treatment to meet their individual utility-specific water quality goals and customer expectations for level of service.
3. Member Governments, acting through the Authority, may provide for common water quality goal-related elective standards more stringent than Federal and State drinking water standards, and.
4. Cost-effective alternative water supplies are developed consistent with Master Water Plan objectives, including diversity of supply sources, and
5. Quality Water delivered by the Authority would not cause a particular Member Government utility to adopt new treatment techniques beyond modified chemical dosages and/or optimization of existing unit processes, to meet a moderately altered source of Quality Water.

Prior to the initiation of any new supply element, a formal review against the criteria set forth above shall be performed by the Authority to evaluate anticipated finished water quality, impacts to existing system water supply quality, and impacts to current member government-specific water treatment practices and costs. This review shall include the presentation of an anticipated raw water operating schedule that defines for each individual Member Government the predominant raw water source, potential significant additional raw water sources, water quality parameters and anticipated levels, and frequency of significant water quality changes.

EXHIBIT E

WATER SERVICE AREAS

EXHIBIT F

RATE

EXHIBIT F

West Coast Regional Water Supply Authority
Unitary Rate for Fiscal Year 1998
Equity Model Scenario Revised March 23, 1998

Expenditures	Projected FY 1998
Debt Service for Existing Facilities	\$ 6,865,736
Salaries and Wages	\$ 5,639,326
Professional, Legal and Other Services	\$ 7,837,434
Other Operating Costs	\$ 9,956,815
Non-Oper Project Expenses & Capital Equipment	\$ 753,079
Annual Credit for Acquired Facilities, Land and Treatment Allowances	\$ 26,846,309
Debt Service for Capital Improvement Projects	\$ 2,073,321
Less Revenues from TBC (15mgd @ \$.08/1000 gallons)	\$ (438,000)
Less Interest Earned	\$ (656,000)
Additional Professional and Legal Services (Acquired Facilities)	\$ 3,325,000
Less Contribution from Regional System Fund Balance	\$ (5,057,716)
Total Projected Expenditures	\$ 57,145,305

West Coast Regional Water Supply Authority
Water Demand Projection

Water Consumption Projections	Projected FY 1998	Projected Percentage
Hillsborough County	34.13	21%
City of Tampa (See Note 1)	5.00	3%
Pasco County	14.66	9%
City of New Port Richey	3.95	2%
Pinellas County	68.89	42%
City of St. Petersburg	37.50	23%
Total Projected Water Demand (MGD)	164.13	100%

Projected Unitary Water Rate \$/1000 gallons	0.9539
Projected Fixed Total	\$ 50,245,305
Projected Variable Total	\$ 6,900,000
	<u>\$ 57,145,305</u>

Note:

- [1] For Unitary Rate Budget purposes, it is assumed that the City of Tampa will receive
 - >> 15.0 mgd of untreated surface water (TBC) @ \$.08/1,000 gallons
 - >> 5.0 mgd of ground water from the Authority's other water supply facilities
- [2] **Acquired Facilities:** Members have the option of receiving lump sum cash or a 30year monthly credit for the Transferred Facilities. The payments are used to offset the cost of water purchased from the Authority. Any tables which estimate Members cost will show a yearly reduction associated with these facilities. If a member takes the lump sum payment the member will control the amount of yearly offset of cost and will not receive a monthly credit from the Authority.
- [3] **Acquired Facilities:** The interest rate for the actual debt service and associated credits will be fixed based upon the municipal interest rates at the time of financing as detailed in the Amended and Restated Interlocal Agreement.

EXHIBIT G

TERMINATED AGREEMENTS

- (1) Transmission Line Agreement by and between St. Petersburg and Pinellas dated July 10, 1973
- (2) Agreement for Development and Operation of the Cypress Creek Wellfield by and between Pinellas, Pasco and St. Petersburg dated August 30, 1974
- (3) Interlocal Agreement Creating WCRWSA dated October 25, 1974 and First Amendment dated May 31, 1977
- (4) Agreement by and between Pinellas and Pasco Water Authority, Inc. dated July 7, 1976 and Addendum dated January 1, 1977
- (5) Agreement by and between Pinellas and Pasco Water Authority, Inc. dated January 11, 1977
- (6) Cross Bar Ranch Wellfield Water Supply Agreement by and between Pinellas and WCRWSA dated April 11, 1979 and Amendment dated January 29, 1980
- (7) Agreement by and between Hillsborough and WCRWSA dated August 28, 1980
- (8) Agreement by and between St. Petersburg and WCRWSA dated September 17, 1980
- (9) Water Supply Contract for Hillsborough County by and between Hillsborough and WCRWSA dated November 10, 1981, along with First Amendment dated August 11, 1982, Second Amendment dated November 23, 1983, Third Amendment dated November 6, 1985, Fourth Amendment dated November 6, 1985, Fifth Amendment dated October 4, 1989, Sixth Amendment dated December 6, 1989, Seventh Amendment dated April 4, 1990, Eighth Amendment dated January 22, 1992, Ninth Amendment dated October 6, 1993, Tenth Amendment dated April 5, 1995 and Eleventh Amendment dated February 21, 1996
- (10) Water Exchange Contract by and between St. Petersburg and WCRWSA dated December 4, 1981 and First Amendment dated April 14, 1984
- (11) Starkey Wellfield Water Supply Contract by and between Pasco, New Port Richey and WCRWSA dated December 15, 1981 and the First Amendment dated October 29, 1982 and the Second Amendment dated June 7, 1988.

(12) Exclusive Water Purchase Agreement by and between Pasco, S.C. Bexley, Angeline Corporation, and L.S.B. Corporation dated August 25, 1983

(13) Water Supply Contract for Tampa Bypass Canal by and between Tampa and WCRWSA dated January 17, 1985

(14) Operation and Management Agreement by and between St. Petersburg and WCRWSA dated March 16, 1987

(15) Surplus Water Supply Contract by and between Hillsborough and WCRWSA dated April 29, 1987

(16) South Central Pasco Water Supply Contract by and between Pasco and WCRWSA dated June 7, 1988

(17) Pasco Excess Water Supply Contract by and between Pasco and WCRWSA dated November 1, 1988

(18) North Pasco Regional Wellfield Water Supply Contract by and between Pasco, New Port Richey and WCRWSA dated January 23, 1990

(19) Agreement to Finance 84 and 66 Inch Investigation and Litigation by and between Pinellas, Pasco, Hillsborough, St. Petersburg and WCRWSA dated December 11, 1990

(20) Regional System Water Supply Contract by and between Pinellas, Pasco, Hillsborough, Tampa, St. Petersburg and WCRWSA dated July 24, 1991

(21) Agreement to Finance Regional System by and between Pinellas, Pasco, Hillsborough, Tampa, St. Petersburg and WCRWSA dated August 6, 1992

(22) Interlocal Agreement for Meter Reporting Services for South Pasco Wellfield by and between St. Petersburg and WCRWSA dated April 19, 1993

(23) Agreement to Finance Regional System by and between Pinellas, Pasco, Hillsborough, Tampa, St. Petersburg and WCRWSA dated April 18, 1994

(24) Morris Bridge Surplus Water Supply Contract by and between WCRWSA and Tampa dated May 20, 1997

(25) Agreement by and between WCRWSA and Pinellas dated September 9, 1997

EXHIBIT H

SURVIVING AGREEMENTS

- (1) Clarification and Reaffirmation of and Assignment of St. Petersburg to the WCRWSA of Any and All Causes of Action in Connection with the Development and Construction of the Cypress Creek Transmission Main dated June 19, 1989
- (2) Clarification and Reaffirmation of and Assignment of Pinellas to the WCRWSA of Any and All Causes of Action in Connection with the Development and Construction of the Cypress Creek Transmission Main dated June 19, 1989
- (3) New Water Source Funding Agreement between SWFWMD and Tampa for the Tampa Water Resource Recovery Implementation Program (F009) dated May 21, 1995 and Amendment dated September 30, 1996 and Second Amendment dated November 6, 1997
- (4) Tampa/Hillsborough County Interconnect Water Supply Agreement by and between WCRWSA and Tampa dated January 21, 1998
- (5) Cooperative Agreement between SWFWMD and WCRWSA for Northwest Hillsborough Interconnect dated February 14, 1996.

EXHIBIT I

MODIFIED AGREEMENTS

(1) Morris Bridge Wellfield Agreement by and between SWFWMD, the Hillsborough River Basin Board and Tampa dated April 22, 1970

(2) Starkey Wellfield Agreement by and between SWFWMD and New Port Richey dated August 16, 1972

(3) Cypress Creek Wellfield Agreement by and between SWFWMD, SWFWMD (Regulatory), Pinellas, Pasco and St. Petersburg dated November 14, 1973

(4) Starkey Wellfield Agreement by and between SWFWMD and New Port Richey dated March 26, 1974 and Supplemental Agreement dated July 16, 1974

(5) Easement Agreement by and between SWFWMD and Tampa dated October 8, 1975

(6) Cypress Creek Wellfield Agreement by and between St. Petersburg and WCRWSA dated November 22, 1976

(7) Cypress Creek Wellfield Agreement by and between Pinellas and WCRWSA dated November 22, 1976

(8) Starkey Wellfield Addendum Agreement by and between SWFWMD and New Port Richey dated March 2, 1977

(9) Cypress Creek Wellfield Agreement by and between Pasco and WCRWSA dated March 22, 1977

(10) Starkey Wellfield Agreement by and between Pasco and New Port Richey dated August 31, 1978

(11) License Agreement for Cypress Creek Wellfield between SWFWMD, Hillsborough River Basin Board, Pinellas-Anclote River Basin Board and WCRWSA dated July 10, 1979.

(12) Cross Bar Ranch Wellfield Agreement by and between Pinellas and WCRWSA dated November 8, 1977

(13) Water Transfer and Management Agreement by and between SWFWMD, New Port Richey and WCRWSA dated December 15, 1981

(14) South Pasco Wellfield License Agreement between St. Petersburg and SWFWMD dated October 9, 1989.

(15) Cypress Creek Wellfield License Agreement by and between SWFWMD and St. Petersburg dated March 18, 1991 and First Amendment dated March 1, 1993

(16) Starkey Wellfield License Agreement by and between SWFWMD and WCRWSA dated May 17, 1993

(17) New Water Source Funding between WCRWSA and Tampa for the Tampa Water Resource Recovery Implementation Program (F009) dated June 19, 1995 and Amendment dated September 30, 1996

EXHIBIT J

SUPERSEDED AGREEMENTS

(1) Interlocal Agreement by and between Tampa and Hillsborough dated June 26, 1979

(2) Section 6 of the Interlocal Agreement by and between Hillsborough and WCRWSA for Financing the Acquisition of the Cone Ranch dated February 17, 1988

EXHIBIT K

FORM OF ANNUAL REPORT

A. SHORT TERM FORECAST

Water Service demand for the next five (5) fiscal years at each of your delivery points and any proposed new delivery points.

1. Average Daily Flow Rates
2. Maximum/Peak Daily Flow Rates
3. Maximum/Instantaneous/Peak Hour Flow Rates (if applicable)
4. Pressure (PSI)
5. Water System Storage Capacity (mg)

B. LONG TERM FORECAST

Anticipated Water Service demand for the next twenty (20) fiscal years at each of your delivery points and any proposed new delivery points (in five year increments).

1. Average Daily Flow Rates
2. Maximum/Peak Daily Flow Rates
3. Maximum/Instantaneous/Peak Hour Flow Rates (if applicable)
4. Pressure (PSI)
5. Water System Storage Capacity (mg)

C. SUPPORTING OPERATIONAL INFORMATION

Please indicate any changes that have or may occur to the following, and provide maps of the changes if available (hard-copy or digital).

1. Points of Connection (including connections with other member governments)
2. Pumping Station/Water Treatment Plant (Facility) Information

D. SUPPORTING PLANNING INFORMATION

Please provide the following data in total and for each of your water service areas (demand planning areas).

1. Per Capita Use
2. Water Conserving Rate Structure
3. Water Audit Program
4. Residential Water Use
5. Reclaimed Water Use
6. Population Estimates (functional service population)
7. Changes to Service Area boundaries (text description and map)

EXHIBIT K

FORM OF ANNUAL REPORT

EXHIBIT L

ARBITRATION DISCOVERY RULES

EXHIBIT L**Discovery Rules for Binding Arbitration****Rule 1: Prehearing Procedure**

- (a) **Arbitration Management Conference.** At any time after the Chair of the Arbitration Panel (hereinafter "Chair") is selected, a party, by serving notice upon the Chair and the opposing party, may convene a case management conference. The matters to be considered shall be specified in the notice setting the conference. At such a conference the Chair may:
- (1) set or reset the time of the arbitration hearing;
 - (2) expand, schedule, order, or expedite discovery;
 - (3) schedule disclosure of expert witnesses and the discovery of facts known and opinions held by such experts;
 - (4) schedule or hear motions to exclude evidence on the grounds that a party did not comply with a request for discovery under these rules;
 - (5) pursue the possibilities of settlement;
 - (6) require filing of preliminary stipulations if issues can be narrowed; and
 - (7) schedule other conferences or determine other matters that may aid in the disposition of the dispute.
- (b) **Prehearing Conference.** Within sixty (60) days before the commencement of the arbitration hearing, a party, by serving a notice upon the Chair and the opposing party, may convene a prehearing conference. At such a conference the Chair shall consider and determine:
- (1) the simplification of the issues;
 - (2) the necessity or desirability of amendments to the Host Member Government's objection or to the Authority's proposed permit application;
 - (3) the possibility of obtaining admissions of fact and of documents that will avoid unnecessary proof;
 - (4) the limitation of the number of expert witnesses; and
 - (5) any matters permitted under subdivision (a) of this rule.
- (c) **Notice.** Ten (10) days' notice shall be given for a arbitration management conference, and 10 days' notice shall be given for a prehearing conference. On failure of a party to attend a conference, the Chair may dismiss the arbitration and render a decision in favor of the non-offending party or it may limit proof or witnesses.
- (d) **Prehearing Order.** The Chair shall make an order reciting the action taken at a conference and any stipulations made. The order shall control the subsequent course of the action

unless modified to prevent injustice.

Rule 2: General Provisions Governing Discovery

- (a) **Discovery Methods.** Parties may obtain discovery by one or more of the following methods: depositions upon oral examination; written interrogatories; and production of documents or things or permission to enter upon land or other property for inspection and other purposes. Unless otherwise expanded by agreement of the parties, the frequency of use of these methods is limited as provided in rules 4, 6, and 7.
- (b) **Scope of Discovery.** The scope of discovery is as follows:
- (1) **In General.** Parties may obtain discovery regarding any matter, not privileged, that is relevant to the issuance, modification or renewal of any Primary Environmental Permit, including, but not limited to, the existence, description, nature, custody, condition, and location of any analyses, books, data, documents, memoranda, reports, tests, test results, or other tangible things and the identity and location of persons having knowledge of any discoverable matter. It is not ground for objection that the information sought would be inadmissible in an administrative hearing or a judicial enforcement hearing.
- (2) **Indemnity Agreements.** The Host Member Government may obtain discovery of the existence and contents of any agreement under which any person may be liable to satisfy part or all of a judgment that may be entered in the action or to indemnify or to reimburse a party for payments made to satisfy the judgment.
- (3) **Hearing Preparation: Materials.** Subject to the provisions of subdivision (b) (4) of this rule, a party may obtain discovery of documents and tangible things otherwise discoverable under subdivision (b) (1) of this rule and prepared in anticipation of the arbitration hearing or any pending or anticipated litigation by or for the opposing party or by or for the opposing party's representative, including, but not limited to, the opposing party's attorney, consultant, surety, indemnitor, insurer, or agent, provided that the mental impressions, conclusions, opinions, or legal theories of an attorney of the opposing party concerning the arbitration hearing or any pending or anticipated litigation shall be protected against disclosure.
- (4) **Hearing Preparation: Experts.** Discovery of facts known and opinions held by experts, otherwise discoverable under the provisions of subdivision (b) (1) of this rule and acquired or developed in anticipation of the arbitration hearing or any pending or anticipated litigation, may be obtained only as follows:
- (A)

- (iii) By interrogatories a party may require the opposing party to identify each person whom the opposing party expects to call as an expert witness at the arbitration hearing and to state the subject matter on which the expert is expected to testify, and to state the substance of the facts and opinions to which the expert is expected to testify and a summary of the grounds for each opinion. Failure to identify any expert witnesses as required or to otherwise comply with this subsection shall result in exclusion of that witnesses' testimony.
- (ii) Any person disclosed by interrogatories or otherwise as a person expected to be called as an expert witness at the arbitration hearing may be deposed in accordance with rule 4. Each expert witness so deposed shall be able to state his or her fully developed opinions regarding the issues about which he or she will be called to testify, except for opinions subsequently developed to rebut the expert opinions of the opposing party's expert witnesses, in which case those subsequently developed rebuttal opinions must be disclosed as required by rule 2(d).
- (iii) A party may obtain the following discovery regarding any person disclosed by interrogatories or otherwise as a person expected to be called as an expert witness at the arbitration hearing:
1. The scope of employment in the pending matter and the compensation for such service.
 2. The expert's general litigation experience, including the percentage of work performed for the Authority or any Member Government.
 3. The identity of other matters, within a reasonable time period, in which the expert has testified by deposition, at hearing or at trial.
 4. An approximation of the portion of the expert's involvement as an expert witness, which may be based on the number of hours, percentage of hours, or percentage of earned income derived from serving as an expert witness.

An expert may be required to produce financial and business records only under the

most unusual or compelling circumstances and may not be compelled to compile or produce nonexistent documents. Upon motion, the chair may order further discovery by other means, subject to such restrictions as to scope and other provisions pursuant to subdivision (b) (4) (C) of this rule concerning fees and expenses as the chair may deem appropriate.

- (B) A party may discover facts known or opinions held by an expert who has been retained or employed by the opposing party, including, but not limited to, those specifically retained or employed with regard the issuance, modification or renewal of a Primary Environmental Permit or in anticipation of the arbitration hearing or any pending or anticipated litigation, and who is not expected to be called as a witness at the arbitration hearing.
- (C) As used in these rules an expert shall be an expert witness as defined in rule 9(a).
- (5) Claims of Privilege or Protection of Trial Preparation Materials. When a party withholds information otherwise discoverable under these rules by claiming that it is privileged or subject to protection, the party shall make the claim expressly and shall for each document or item so withheld identify the following:
 - (A) The type of document or information;
 - (B) The date on which it was prepared;
 - (C) The author;
 - (D) The identity of all persons shown as having seen or received a copy of the document;
 - (E) The subject matter of the document; and
 - (F) The privilege or exception to discovery upon which withholding is based.

- (c) Sequence and Timing of Discovery. The methods of discovery may be used in any sequence.
- (d) Supplementing of Responses. Once a party has responded to a request for discovery with a response that was complete when made, it is under a continuing duty to supplement the response to include information thereafter acquired.

Rule 3: Persons Before Whom Depositions May Be Taken

- (a) Persons Authorized. Depositions may be taken before any notary public or any officer authorized by the statutes of Florida to take acknowledgments or proof of executions of deeds.

- (b) Persons Disqualified. No deposition shall be taken before a person who is an employee, attorney, or counsel of any party or that is a relative or employee of any parties' attorney or counsel.

Rule 4: Depositions Upon Oral Examination

- (a) When Depositions May Be Taken. At any time after ten (10) days from the selection of the Chair, a party may take the testimony of any person by deposition upon oral examination. However, the Host Member Government may take depositions prior to ten (10) days after the selection of the Chair with the approval of a majority of the Authority's Board of Directors. Each party is entitled to take up to ten (10) depositions. Each deposition shall not exceed eight (8) hours in duration, excluding time taken for breaks, without the consent of the opposing party's attorney. The attendance of witnesses may be compelled by subpoena as provided in rule 10.
- (b) Notice; Method of Taking; Production at Deposition.
- (1) A party may take the deposition of any person upon oral examination upon giving ten (10) days notice, in writing, to the opposing party. The notice shall state the time and place for taking the deposition and the name and address of each person to be examined, if known, and, if the name is not known, a general description sufficient to identify the person or the particular class or group to which the person belongs. If a subpoena duces tecum is to be served on the person to be examined the designation of the materials to be produced under the subpoena shall be attached to or included in the notice.
 - (2) For cause shown, the Chair may enlarge the number of depositions permitted by these rules or the time for taking the deposition.
 - (3) Any deposition may be recorded by videotape without leave of the Chair or stipulation of the opposing party, provided the deposition is taken in accordance with this subdivision.
 - (A) Notice. If a party intends to videotape a deposition, the party shall state in the notice that the deposition is to be videotaped and shall give the name and address of the operator.
 - (B) Stenographer. Videotaped depositions shall also be recorded stenographically.
 - (C) Procedure. At the beginning of the deposition, the officer before whom it is taken shall, on camera: (i) identify the persons present, (ii) state the date, and (iii) swear the witness.
 - (D) Custody of Tape and Copies. The attorney for the

- party taking the deposition shall take custody of and be responsible for the safeguarding of the videotape, shall permit the viewing of it by the opposing party, and, if requested, shall provide a copy of the videotape to the opposing party at the opposing party's expense.
- (E) Cost of Videotaped Depositions. The party taking the deposition shall bear the initial cost of videotaping.
- (4) The notice to a deponent may be accompanied by a request made in compliance with rule 7 for the production of documents and tangible things at the taking of the deposition. The procedure of rule 7 shall apply to the request.
- (5) In the notice, the party may identify the matters on which examination is requested. The opposing party shall designate one or more officers, managing agents, or other persons to testify on its behalf. The persons so designated shall testify about matters known or reasonably available to the organization. This subdivision does not preclude taking a deposition by any other procedure authorized in these rules.
- (c) Examination and Cross-Examination; Record of Examination; Oath; Objections. Examination and cross-examination of witnesses is specifically authorized. The officer before whom the deposition is to be taken shall put the witness on oath and shall personally, or by someone acting under the officer's direction and in the officer's presence, record the testimony of the witness. The testimony shall be taken stenographically. If requested by one of the parties, the testimony shall be transcribed at the initial cost of the requesting party and prompt notice of the request shall be given to the other party. All objections made at time of the examination to the qualifications of the officer taking the deposition, the manner of taking it, the evidence presented, or the conduct of any party, and any other objection to the proceedings shall be noted by the officer upon the deposition. Any objection during a deposition shall be stated concisely and in a nonargumentative and nonsuggestive manner. A party may instruct a deponent not to answer only when necessary to preserve a privilege. Otherwise, evidence objected to shall be taken subject to the objections.
- (d) Witness Review. If the testimony is transcribed, the transcript shall be furnished to the witness for examination and shall be read to or by the witness unless the examination and reading are waived by the witness and by the parties. Any changes in form or substance that the witness wants to make shall be listed in writing by the officer with a statement of the reasons given by the witness for making

the changes. The changes shall be attached to the transcript. It shall then be signed by the witness unless the parties waived the signing or the witness is ill, cannot be found, or refuses to sign. If the transcript is not signed by the witness within ten (10) days after it is furnished to the witness, the officer shall sign the transcript and state on the transcript the waiver, illness, absence of the witness, or refusal to sign with any reasons given therefor. The deposition may then be used as fully as though signed.

(e) Exhibits.

- (1) If the deposition is transcribed, the officer shall certify on each copy of the deposition that the witness was duly sworn by the officer and that the deposition is a true record of the testimony given by the witness. Documents and things produced for inspection during the examination of the witness shall be marked for identification and annexed to and returned with the deposition upon the request of the party, and may be inspected and copied by the party, except that the person producing the materials may substitute copies to be marked for identification if that person affords to the party fair opportunity to verify the copies by comparison with the originals. If the person producing the materials requests their return, the officer shall mark them, give the party an opportunity to inspect and copy them, and return them to the person producing them and the materials may then be used in the same manner as if annexed to and returned with the deposition.
- (2) Upon payment of reasonable charges therefor the officer shall furnish a copy of the deposition to any party or to the deponent.

(f) Obtaining Copies. A party or witness who does not have a copy of the deposition may obtain it from the officer taking the deposition.

Rule 5: Use of Depositions in Binding Arbitration

- (a) Use of Depositions. At the hearing, any part or all of a deposition may be used against either party who was present or represented at the taking of the deposition or who had reasonable notice as though the witness were then present and testifying in accordance with any of the following provisions:
- (1) Any deposition may be used by any party for the purpose of contradicting or impeaching the testimony of the deponent as a witness.
 - (2) The deposition of anyone who at the time of taking the deposition was an officer, director, managing agent,

- consultant, employee of a party or a person designated under rule 4(b)(5) to testify on behalf of the party may be used by the opposing party for any purpose.
- (3) The deposition of a witness may be used by either party if the Chair finds:
- (A) That the witness is dead;
 - (B) That the witness is at a greater distance than 100 miles from the place of the hearing, or is out of the state, unless it appears that the absence of the witness was procured by the party offering the deposition;
 - (C) That the witness is unable to attend or testify because of age, illness, infirmity, or imprisonment;
 - (D) Upon application and notice, that such exceptional circumstances exist as to make it desirable, in the interest of justice and with due regard to the importance of presenting the testimony of witnesses orally in the hearing, to allow the deposition to be used; or
 - (E) The witness is an expert or skilled witness.
- (4) If only part of a deposition is offered in evidence by a party, the adverse party may require the party to introduce any other part that in fairness ought to be considered with the part introduced, and the other party may introduce any other parts.
- (b) **Objections to Admissibility.** Subject to the provisions of subdivision (d)(3) of this rule, objection may be made at the hearing to receiving in evidence any deposition or part of it for any reason that would require the exclusion of the evidence if the witness were then present and testifying.
- (c) **Effect of Taking or Using Depositions.** A party does not make a person it's own witness for any purpose by taking the person's deposition or by introducing into evidence the deposition or any part of it. At the hearing, the either party may rebut any relevant evidence contained in a deposition whether introduced by that party or by the other party.
- (d) **Effect of Errors and Irregularities.**
- (1) **As to Notice.** All errors and irregularities in the notice for taking a deposition are waived unless written objection is served upon the opposing party and the Chair within five (5) days of receipt of said notice.
 - (2) **As to Disqualification of Officer.** Objection to taking a deposition because of disqualification of the officer before whom it is to be taken is waived unless made before the taking of the deposition begins or as soon thereafter as the disqualification becomes known or

- could be discovered with reasonable diligence.
- (3) As to Taking of Deposition.
- (A) Objections to the competency of a witness or to the competency, relevancy, or materiality of testimony are not waived by failure to make them before or during the taking of the deposition unless the ground of the objection is one that might have been obviated or removed if presented at that time.
- (B) Errors and irregularities occurring at the oral examination in the manner of taking the deposition, in the form of the questions or answers, in the oath or affirmation, or in the conduct of parties and errors of any kind that might be obviated, removed, or cured if promptly presented are waived unless timely objection to them is made at the taking of the deposition.
- (4) As to Completion and Return. Errors and irregularities in the manner in which the testimony is transcribed or the deposition is prepared, signed, certified, or otherwise dealt with by the officer under rule 4 are waived unless a motion to suppress the deposition or some part of it is made and served upon the chair and other party within five (5) days after the defect is, or with due diligence might have been, discovered.

Rule 6: Interrogatories to Parties

- (a) Procedure for Use. At any time after thirty (30) days from the date the Host Member Government provides the Authority with notice under Section 3.13(A) of the Amended and Restated Interlocal Agreement, a party may serve upon the other party written interrogatories to be answered by any officer or agent designated to answer the interrogatories on its behalf. The interrogatories shall not exceed 25, including all subparts, unless the Chair permits a greater number. Each interrogatory shall be answered separately and fully in writing under oath unless it is objected to, in which event the grounds for objection shall be stated and signed by the attorney making it. The party to whom the interrogatories are directed shall serve the answers and any objections within thirty (30) days after the service of the interrogatories. The party submitting the interrogatories may move the Chair for an order under rule 8 on any objection to or other failure to answer an interrogatory.
- (b) Scope; Use at Hearing. Interrogatories may relate to any matters that can be inquired into under rule 2(b), and the answers may be used to the extent that they are relevant and material. An interrogatory otherwise proper is not objectionable merely because an answer to the interrogatory

involves an opinion or contention that relates to fact or calls for a conclusion or asks for information not within the personal knowledge of the party. A party shall respond to such an interrogatory by giving the information the party has and the source on which the information is based. If a party introduces an answer to an interrogatory, the other party may require that party to introduce any other interrogatory and answer that in fairness ought to be considered with it.

- (c) Service and Filing. Interrogatories shall be arranged so that a blank space is provided after each separately numbered interrogatory. The space shall be reasonably sufficient to enable the answering party to insert the answer within the space. If sufficient space is not provided, the answering party may attach additional papers with answers and refer to them in the space provided in the interrogatories. The original or any copy of the answers to interrogatories may be filed by any party when the arbitration panel should consider the answers to interrogatories in rendering a decision. The Chair may order a copy of the answers to interrogatories filed at any time when the chair determines that examination of the answers to interrogatories would assist the arbitration panel in rendering a decision.

Rule 7: Production of Documents and Things and Entry Upon Land for Inspection and Other Purposes

- (a) Request; Scope. A party may request the opposing party (1) to produce and permit the party making the request to inspect and copy any designated documents, including, but not limited to, analyses, books, charts, data, documents, drawings, graphs, memoranda, photographs, phono-records, and other data compilations, reports, tests, test results, writings, or other tangible things from which information can be obtained, translated, if necessary, by the opposing party through detection devices into reasonably usable form, that constitute or contain matters within the scope of rule 2(b) and that are in the possession, custody, or control of the opposing party or any person employed, retained or contracted by the opposing party; (2) to inspect and copy, test, or sample any tangible things that constitute or contain matters within the scope of rule 2(b) and that are in the possession, custody, or control of the opposing party or any person employed, retained or contracted by the opposing party; or (3) to permit entry upon designated land or other property in the possession or control of the opposing party or any Member Government for the purpose of inspection and measuring, surveying, photographing, testing, or sampling the property or any designated object or

operation on it within the scope of rule 2(b).

- (b) Procedure. At any time after thirty (30) days from the date the Host Member Government provides the Authority with notice under Section 3.13(A) of the Amended and Restated Interlocal Agreement, a party may serve the request upon the opposing party. The request shall set forth the items to be inspected, either by individual item or category, and describe each item and category with reasonable particularity. The request shall specify a reasonable time, place, and manner of making the inspection or performing the related acts. The party to whom the request is directed shall serve a written response within fifteen (15) days after service of the request. For each item or category the response shall state that inspection and related activities will be permitted as requested unless the request is objected to, in which event the reasons for the objection shall be stated. If an objection is made to part of an item or category, the part shall be specified. When producing documents, the producing party shall either produce them as they are kept in the usual course of business or shall identify them to correspond with the categories in the request. The party submitting the request may move for an order under rule 8 concerning any objection, failure to respond to the request, or any part of it, or failure to permit inspection as requested.
- (c) Persons Not Parties. This rule does not preclude an independent action against a person not a party for production of documents and things and permission to enter upon land.
- (d) Filing of Documents. Unless required by the chair, a party should not file any of the documents or things produced with the response. Documents or things may be filed when they should be considered by the arbitration panel in rendering a decision.

Rule 8: Failure to Make Discovery: Sanctions

- (a) Motion for Order Compelling Discovery. A party may apply to the Chair for an order compelling discovery as follows:
- (1) Motion. If a deponent fails to answer a question propounded or submitted under rule 4 or a party fails to make a designation under rule 4(b)(5), or if a party fails to answer an interrogatory submitted under rule 6, or if a party in response to a request for inspection submitted under rule 7 fails to respond that inspection will be permitted as requested or fails to permit inspection as requested, the discovering party may move the Chair for an order compelling an answer,

or a designation or an order compelling inspection in accordance with the request. The Chair shall make a final determination on the motion within five (5) business days. When taking a deposition on oral examination, the proponent of the question may complete or adjourn the examination before applying for an order.

- (2) Evasive or Incomplete Answer. For purposes of this subdivision an evasive or incomplete answer shall be treated as a failure to answer.
- (b) Failure to Comply With Order. If an officer, managing agent, employee, consultant, or person designated under rule 4(b)(5) to testify on behalf of a party fails to obey an order to provide or permit discovery, including an order made under subdivision (a) of this rule, the Chair shall make the following orders:
- (1) An order that the matters regarding which the questions were asked or any other designated facts shall be taken to be established for the purposes of the arbitration hearing in accordance with the position of the party obtaining the order; and
 - (2) An order refusing to allow the disobedient party to support or oppose designated positions and prohibiting that party from introducing designated matters in evidence.

- In addition, the Chair may dismiss the arbitration and render a judgment by default against the disobedient party.
- (c) Failure of Party to Attend Deposition or Serve Answers to Interrogatories or Respond to Request for Inspection. If an officer, managing agent, employee, consultant, or person designated under rule 4(b)(5) to testify on behalf of a party fails (1) to appear before the officer who is to take the deposition after being served with a proper notice, (2) to serve answers or objections to interrogatories submitted under rule 6 after proper service of the interrogatories, or (3) to serve a written response to a request for inspection submitted under rule 7 after proper service of the request, the Chair may, except as otherwise provided for in these rules, take any action authorized under subdivision (b) of this rule.

Rule 9: Depositions of Expert Witnesses

- (a) Definition. The term "expert witness" as used herein applies exclusively to a person duly and regularly engaged in the practice of a profession who holds a professional degree from a university or college and has had special professional training and experience, or one possessed of special knowledge or skill about the subject upon which called to testify.

- (b) Procedure. The testimony of an expert or skilled witness may be taken at any time before the arbitration hearing in accordance with the rules for taking depositions and may be used at the arbitration hearing, regardless of the place of residence of the witness or whether the witness is within the distance prescribed by rule 5(a)(3). Each expert witness deposed shall be able to state his or her fully developed opinion regarding the issues about which he or she will be called to testify, except for opinions subsequently developed to rebut the expert opinions of the opposing party's expert witnesses, in which case those subsequently developed rebuttal opinions must be disclosed as required by rule 2(d). The failure of an expert witness to have fully developed opinions by the date he or she is deposed shall result in the exclusion of that expert witnesses' testimony to the extent that such opinions are not fully developed. No special form of notice need be given that the deposition will be used for the arbitration hearing.
- (c) Applicability. Nothing in this rule shall prevent the taking of any deposition as otherwise provided by these rules.

Rule 10: Subpoena

Pursuant to Section 682.08, Florida Statutes, the Chair of the Arbitration Panel shall have the power to issue subpoenas for the attendance of witnesses and for the production of books, records, documents and other evidence, and shall have the power to administer oaths.

Appendix I: Summary of Study Water Quality Results

Level	Analyte	Date	Final Unit	Qualifier	Type	Sample Name	MDL	Result	Group
Level-1	Bromide	12/26/2018	mg/L		Source Well	MB153	0.02	0.05	8-2
Level-1	Bromide	12/26/2018	mg/L		Source Well	MB154	0.02	0.05	8-2
Level-1	Bromide	12/26/2018	mg/L		Source Well	MB159	0.02	0.05	8-6
Level-1	Fluoride	12/26/2018	mg/L		Source Well	CB8	0.01	0.052	2-1
Level-1	Fluoride	12/26/2018	mg/L		Source Well	CB9	0.01	0.059	2-1
Level-1	Bromide	12/26/2018	mg/L		Source Well	CB9	0.02	0.071	2-1
Level-1	Bromide	12/26/2018	mg/L		Source Well	MB158	0.02	0.074	8-5
Level-1	Bromide	12/26/2018	mg/L		Source Well	MB169	0.02	0.075	8-0
Level-1	Bromide	12/26/2018	mg/L		Source Well	ST4	0.02	0.075	13-4
Level-1	Bromide	12/26/2018	mg/L		Source Well	ST8	0.02	0.075	13-4
Level-1	Bromide	12/26/2018	mg/L		Source Well	MB167	0.02	0.076	8-11
Level-1	Bromide	12/26/2018	mg/L		Source Well	MB157	0.02	0.078	8-2
Level-1	Bromide	12/26/2018	mg/L		Source Well	MB151	0.02	0.079	8-3
Level-1	Bromide	12/26/2018	mg/L		Source Well	ST7	0.02	0.08	13-4
Level-1	Bromide	12/26/2018	mg/L		Source Well	ELW102	0.02	0.081	7-3
Level-1	Bromide	12/26/2018	mg/L		Source Well	ELW135	0.02	0.086	7-11
Level-1	Fluoride	12/26/2018	mg/L		Source Well	MB154	0.01	0.1	8-2
Level-1	Fluoride	12/26/2018	mg/L		Source Well	MB157	0.01	0.109	8-2
Level-1	Fluoride	12/26/2018	mg/L		Source Well	MB153	0.01	0.11	8-2
Level-1	Fluoride	12/26/2018	mg/L		Source Well	MB159	0.01	0.11	8-6
Level-1	Fluoride	12/26/2018	mg/L		Source Well	ELW102	0.01	0.118	7-3
Level-1	Fluoride	12/26/2018	mg/L		Source Well	MB158	0.01	0.12	8-5
Level-1	Fluoride	12/26/2018	mg/L		Source Well	ELW135	0.01	0.125	7-11
Level-1	Fluoride	12/26/2018	mg/L		Source Well	MB151	0.01	0.125	8-3
Level-1	Fluoride	12/26/2018	mg/L		Source Well	MB169	0.01	0.126	8-0
Level-1	Fluoride	12/26/2018	mg/L		Source Well	ST8	0.01	0.131	13-4
Level-1	Fluoride	12/26/2018	mg/L		Source Well	MB167	0.01	0.135	8-11
Level-1	Fluoride	12/26/2018	mg/L		Source Well	ST7	0.01	0.15	13-4
Level-1	Sulfate	12/26/2018	mg/L		Source Well	MB154	0.06	0.15	8-2
Level-1	Fluoride	12/26/2018	mg/L		Source Well	ST4	0.01	0.161	13-4
Level-1	Sulfate	12/26/2018	mg/L		Source Well	MB153	0.06	0.18	8-2
Level-1	Sulfate	12/26/2018	mg/L		Source Well	CB9	0.06	0.258	2-1
Level-1	Sulfate	12/26/2018	mg/L		Source Well	MB151	0.06	0.261	8-3
Level-1	Sulfate	12/26/2018	mg/L		Source Well	CB8	0.06	0.265	2-1
Level-1	Sulfate	12/26/2018	mg/L		Source Well	MB159	0.06	0.35	8-6
Level-1	Sulfate	12/26/2018	mg/L		Source Well	ELW135	0.06	1.01	7-11
Level-1	Sulfate	12/26/2018	mg/L		Source Well	MB157	0.06	1.18	8-2
Level-1	Sulfate	12/26/2018	mg/L		Source Well	ELW102	0.06	1.43	7-3
Level-1	Sulfate	12/26/2018	mg/L		Source Well	MB169	0.06	1.72	8-0
Level-1	Chloride	12/26/2018	mg/L		Source Well	ST7	0.04	10.1	13-4
Level-1	Chloride	12/26/2018	mg/L		Source Well	ELW135	0.04	10.2	7-11
Level-1	Chloride	12/26/2018	mg/L		Source Well	MB151	0.04	10.5	8-3
Level-1	Sulfate	12/26/2018	mg/L		Source Well	MB167	0.06	11.1	8-11
Level-1	Sulfate	12/26/2018	mg/L		Source Well	ST8	0.06	2.29	13-4
Level-1	Total Organic Carbon (TOC)	12/26/2018	mg/L		Source Well	CB9	0.09	2.77	2-1
Level-1	Total Organic Carbon (TOC)	12/26/2018	mg/L		Source Well	MB158	0.09	2.94	8-5
Level-1	Total Organic Carbon (TOC)	12/26/2018	mg/L		Source Well	CB8	0.09	2.98	2-1
Level-1	Temperature	12/26/2018	oC		Source Well	MB154	0.1	24	8-2
Level-1	Temperature	12/26/2018	oC		Source Well	MB157	0.1	24	8-2
Level-1	Temperature	12/26/2018	oC		Source Well	MB167	0.1	24.2	8-11
Level-1	Temperature	12/26/2018	oC		Source Well	MB169	0.1	24.3	8-0
Level-1	Temperature	12/26/2018	oC		Source Well	MB153	0.1	24.7	8-2
Level-1	Temperature	12/26/2018	oC		Source Well	MB159	0.1	24.7	8-6
Level-1	Temperature	12/26/2018	oC		Source Well	MB158	0.1	24.9	8-5
Level-1	Temperature	12/26/2018	oC		Source Well	MB151	0.1	25.1	8-3
Level-1	Temperature	12/26/2018	oC		Source Well	ST8	0.1	25.5	13-4
Level-1	TDS	12/26/2018	mg/L		Source Well	ST4	10	267	13-4
Level-1	TDS	12/26/2018	mg/L		Source Well	ST8	10	267	13-4

Level	Analyte	Date	Final Unit	Qualifier	Type	Sample Name	MDL	Result	Group
Level-1	TDS	12/26/2018	mg/L		Source Well	MB169	10	277	8-0
Level-1	TDS	12/26/2018	mg/L		Source Well	MB154	10	278	8-2
Level-1	TDS	12/26/2018	mg/L		Source Well	MB153	10	291	8-2
Level-1	TDS	12/26/2018	mg/L		Source Well	MB151	10	294	8-3
Level-1	TDS	12/26/2018	mg/L		Source Well	MB157	10	296	8-2
Level-1	TDS	12/26/2018	mg/L		Source Well	MB158	10	296	8-5
Level-1	Sulfate	12/26/2018	mg/L		Source Well	MB158	0.06	3.32	8-5
Level-1	Total Organic Carbon (TOC)	12/26/2018	mg/L		Source Well	MB167	0.09	3.35	8-11
Level-1	Total Organic Carbon (TOC)	12/26/2018	mg/L		Source Well	MB169	0.09	3.76	8-0
Level-1	TDS	12/26/2018	mg/L		Source Well	MB167	10	300	8-11
Level-1	TDS	12/26/2018	mg/L		Source Well	MB159	10	306	8-6
Level-1	Total Organic Carbon (TOC)	12/26/2018	mg/L		Source Well	MB151	0.09	4.17	8-3
Level-1	Total Organic Carbon (TOC)	12/26/2018	mg/L		Source Well	MB159	0.09	4.58	8-6
Level-1	Total Organic Carbon (TOC)	12/26/2018	mg/L		Source Well	MB153	0.09	4.63	8-2
Level-1	Total Organic Carbon (TOC)	12/26/2018	mg/L		Source Well	MB157	0.09	4.77	8-2
Level-1	Total Organic Carbon (TOC)	12/26/2018	mg/L		Source Well	ST4	0.09	4.77	13-4
Level-1	Conductivity	12/26/2018	umhos/cm		Source Well	CB9	1	414	2-1
Level-1	Conductivity	12/26/2018	umhos/cm		Source Well	ELW102	1	414	7-3
Level-1	Conductivity	12/26/2018	umhos/cm		Source Well	CB8	1	415	2-1
Level-1	Conductivity	12/26/2018	umhos/cm		Source Well	ELW135	1	444	7-11
Level-1	Conductivity	12/26/2018	umhos/cm		Source Well	ST4	1	466	13-4
Level-1	Conductivity	12/26/2018	umhos/cm		Source Well	ST8	1	475	13-4
Level-1	Total Organic Carbon (TOC)	12/26/2018	mg/L		Source Well	MB154	0.09	5.19	8-2
Level-1	Total Organic Carbon (TOC)	12/26/2018	mg/L		Source Well	ST8	0.09	5.35	13-4
Level-1	Total Organic Carbon (TOC)	12/26/2018	mg/L		Source Well	ELW135	0.09	5.67	7-11
Level-1	Total Organic Carbon (TOC)	12/26/2018	mg/L		Source Well	ST7	0.09	5.72	13-4
Level-1	Conductivity	12/26/2018	umhos/cm		Source Well	ST7	1	508	13-4
Level-1	Conductivity	12/26/2018	umhos/cm		Source Well	MB154	1	542	8-2
Level-1	Conductivity	12/26/2018	umhos/cm		Source Well	MB169	1	568	8-0
Level-1	Conductivity	12/26/2018	umhos/cm		Source Well	MB157	1	582	8-2
Level-1	Conductivity	12/26/2018	umhos/cm		Source Well	MB151	1	583	8-3
Level-1	Conductivity	12/26/2018	umhos/cm		Source Well	MB158	1	584	8-5
Level-1	Conductivity	12/26/2018	umhos/cm		Source Well	MB153	1	590	8-2
Level-1	Conductivity	12/26/2018	umhos/cm		Source Well	MB167	1	595	8-11
Level-1	Conductivity	12/26/2018	umhos/cm		Source Well	MB159	1	598	8-6
Level-1	Total Organic Carbon (TOC)	12/26/2018	mg/L		Source Well	ELW102	0.09	6.12	7-3
Level-1	Sulfate	12/26/2018	mg/L		Source Well	ST7	0.06	6.18	13-4
Level-1	Chloride	12/26/2018	mg/L		Source Well	CB8	0.04	6.85	2-1
Level-1	Chloride	12/26/2018	mg/L		Source Well	CB9	0.04	6.97	2-1
Level-1	pH	12/26/2018	pH Units		Source Well	ST7	0.01	7.09	13-4
Level-1	pH	12/26/2018	pH Units		Source Well	MB154	0.01	7.13	8-2
Level-1	pH	12/26/2018	pH Units		Source Well	ST4	0.01	7.15	13-4
Level-1	pH	12/26/2018	pH Units		Source Well	MB157	0.01	7.17	8-2
Level-1	pH	12/26/2018	pH Units		Source Well	MB159	0.01	7.19	8-6
Level-1	Temperature	12/26/2018	oC		Source Well	ST4	0.1	7.2	13-4
Level-1	pH	12/26/2018	pH Units		Source Well	ELW102	0.01	7.2	7-3
Level-1	pH	12/26/2018	pH Units		Source Well	ELW135	0.01	7.2	7-11
Level-1	pH	12/26/2018	pH Units		Source Well	MB151	0.01	7.21	8-3
Level-1	pH	12/26/2018	pH Units		Source Well	MB153	0.01	7.21	8-2
Level-1	pH	12/26/2018	pH Units		Source Well	MB167	0.01	7.25	8-11
Level-1	pH	12/26/2018	pH Units		Source Well	MB169	0.01	7.25	8-0
Level-1	pH	12/26/2018	pH Units		Source Well	ST8	0.01	7.25	13-4
Level-1	pH	12/26/2018	pH Units		Source Well	MB158	0.01	7.27	8-5

Level	Analyte	Date	Final Unit	Qualifier	Type	Sample Name	MDL	Result	Group
Level-1	pH	12/26/2018	pH Units		Source Well	CB8	0.01	7.3	2-1
Level-1	pH	12/26/2018	pH Units		Source Well	CB9	0.01	7.33	2-1
Level-1	Sulfate	12/26/2018	mg/L		Source Well	ST4	0.06	7.65	13-4
Level-1	Chloride	12/26/2018	mg/L		Source Well	ST8	0.04	8.5	13-4
Level-1	Chloride	12/26/2018	mg/L		Source Well	ST4	0.04	8.64	13-4
Level-1	Chloride	12/26/2018	mg/L		Source Well	MB154	0.04	8.66	8-2
Level-1	Chloride	12/26/2018	mg/L		Source Well	ELW102	0.04	8.68	7-3
Level-1	Chloride	12/26/2018	mg/L		Source Well	MB158	0.04	8.75	8-5
Level-1	Chloride	12/26/2018	mg/L		Source Well	MB169	0.04	8.91	8-0
Level-1	Chloride	12/26/2018	mg/L		Source Well	MB153	0.04	9.24	8-2
Level-1	Chloride	12/26/2018	mg/L		Source Well	MB167	0.04	9.54	8-11
Level-1	Chloride	12/26/2018	mg/L		Source Well	MB159	0.04	9.71	8-6
Level-1	Chloride	12/26/2018	mg/L		Source Well	MB157	0.04	9.88	8-2
Level-1	Iron	12/20/2018	mg/L		Source Well	NWH3	0.001	0.021	9-3
Level-1	Iron	12/20/2018	mg/L		Source Well	NWH4	0.001	0.038	9-3
Level-1	Bromide	12/20/2018	mg/L	l	Source Well	ELW121	0.02	0.069	7-8
Level-1	Bromide	12/20/2018	mg/L	l	Source Well	ELW122	0.02	0.074	7-6
Level-1	Bromide	12/20/2018	mg/L	l	Source Well	CC4	0.02	0.076	3-1
Level-1	Bromide	12/20/2018	mg/L	l	Source Well	NWH3	0.02	0.08	9-3
Level-1	Bromide	12/20/2018	mg/L	l	Source Well	NWH4	0.02	0.08	9-3
Level-1	Total Sulfide	12/20/2018	mg/L		Source Well	NWH4	0.01	0.08	9-3
Level-1	Bromide	12/20/2018	mg/L	l	Source Well	ELW112	0.02	0.082	7-3
Level-1	Bromide	12/20/2018	mg/L	l	Source Well	NWH1	0.02	0.085	9-1
Level-1	Bromide	12/20/2018	mg/L	l	Source Well	ELW134	0.02	0.089	7-10
Level-1	Bromide	12/20/2018	mg/L	l	Source Well	ELW142	0.02	0.092	7-3
Level-1	Turbidity	12/20/2018	NTU		Source Well	NWH4	0.01	0.11	9-3
Level-1	Fluoride	12/20/2018	mg/L	l	Source Well	ELW142	0.01	0.115	7-3
Level-1	Fluoride	12/20/2018	mg/L	l	Source Well	ELW112	0.01	0.116	7-3
Level-1	Fluoride	12/20/2018	mg/L	l	Source Well	ELW134	0.01	0.116	7-10
Level-1	Fluoride	12/20/2018	mg/L	l	Source Well	NWH3	0.01	0.12	9-3
Level-1	Fluoride	12/20/2018	mg/L	l	Source Well	NWH1	0.01	0.125	9-1
Level-1	Fluoride	12/20/2018	mg/L	l	Source Well	NWH4	0.01	0.126	9-3
Level-1	Fluoride	12/20/2018	mg/L	l	Source Well	CC4	0.01	0.129	3-1
Level-1	Fluoride	12/20/2018	mg/L	l	Source Well	ELW122	0.01	0.133	7-6
Level-1	Fluoride	12/20/2018	mg/L	l	Source Well	ELW121	0.01	0.155	7-8
Level-1	Total Sulfide	12/20/2018	mg/L		Source Well	NWH3	0.01	0.24	9-3
Level-1	Sulfate	12/20/2018	mg/L	l	Source Well	NWH4	0.06	0.245	9-3
Level-1	Turbidity	12/20/2018	NTU		Source Well	NWH3	0.01	0.29	9-3
Level-1	Sulfate	12/20/2018	mg/L	l	Source Well	NWH3	0.06	0.418	9-3
Level-1	Sulfate	12/20/2018	mg/L		Source Well	NWH1	0.06	1.39	9-1
Level-1	Sulfate	12/20/2018	mg/L		Source Well	ELW112	0.06	1.47	7-3
Level-1	Sulfate	12/20/2018	mg/L		Source Well	ELW142	0.06	1.83	7-3
Level-1	Chloride	12/20/2018	mg/L		Source Well	NWH3	0.04	10.1	9-3
Level-1	Chloride	12/20/2018	mg/L		Source Well	NWH4	0.04	11.1	9-3
Level-1	Chloride	12/20/2018	mg/L		Source Well	NWH1	0.04	11.5	9-1
Level-1	Chloride	12/20/2018	mg/L		Source Well	ELW142	0.04	16.8	7-3
Level-1	Sulfate	12/20/2018	mg/L		Source Well	ELW122	0.06	2.56	7-6
Level-1	Total Organic Carbon (TOC)	12/20/2018	mg/L		Source Well	ELW121	0.09	2.66	7-8
Level-1	Temperature	12/20/2018	oC		Source Well	CC4	0.1	23.2	3-1
Level-1	Chloride	12/20/2018	mg/L		Source Well	ELW134	0.04	23.8	7-10
Level-1	TDS	12/20/2018	mg/L		Source Well	NWH3	10	239	9-3
Level-1	Temperature	12/20/2018	oC		Source Well	NWH4	0.1	24.6	9-3
Level-1	TDS	12/20/2018	mg/L		Source Well	NWH4	10	241	9-3
Level-1	Temperature	12/20/2018	oC		Source Well	NWH3	0.1	25.3	9-3
Level-1	Sulfate	12/20/2018	mg/L		Source Well	CC4	0.06	25.9	3-1
Level-1	TDS	12/20/2018	mg/L		Source Well	CC4	10	297	3-1
Level-1	Total Organic Carbon (TOC)	12/20/2018	mg/L		Source Well	NWH1	0.09	3.01	9-1
Level-1	Total Organic Carbon (TOC)	12/20/2018	mg/L		Source Well	NWH3	0.09	3.27	9-3

Level	Analyte	Date	Final Unit	Qualifier	Type	Sample Name	MDL	Result	Group
Level-1	Total Organic Carbon (TOC)	12/20/2018	mg/L		Source Well	ELW122	0.09	3.68	7-6
Level-1	Total Organic Carbon (TOC)	12/20/2018	mg/L		Source Well	ELW134	0.09	3.86	7-10
Level-1	Total Organic Carbon (TOC)	12/20/2018	mg/L		Source Well	CC4	0.09	3.93	3-1
Level-1	Conductivity	12/20/2018	umhos/cm		Source Well	ELW121	1	341	7-8
Level-1	Conductivity	12/20/2018	umhos/cm		Source Well	NWH1	1	392	9-1
Level-1	Total Organic Carbon (TOC)	12/20/2018	mg/L		Source Well	NWH4	0.09	4.31	9-3
Level-1	Total Organic Carbon (TOC)	12/20/2018	mg/L		Source Well	ELW142	0.09	4.85	7-3
Level-1	Conductivity	12/20/2018	umhos/cm		Source Well	ELW122	1	405	7-6
Level-1	Conductivity	12/20/2018	umhos/cm		Source Well	ELW112	1	413	7-3
Level-1	Conductivity	12/20/2018	umhos/cm		Source Well	NWH3	1	417	9-3
Level-1	Conductivity	12/20/2018	umhos/cm		Source Well	NWH4	1	437	9-3
Level-1	Total Organic Carbon (TOC)	12/20/2018	mg/L		Source Well	ELW112	0.09	5.33	7-3
Level-1	Conductivity	12/20/2018	umhos/cm		Source Well	ELW142	1	510	7-3
Level-1	Conductivity	12/20/2018	umhos/cm		Source Well	ELW134	1	512	7-10
Level-1	Conductivity	12/20/2018	umhos/cm		Source Well	CC4	1	567	3-1
Level-1	Sulfate	12/20/2018	mg/L		Source Well	ELW134	0.06	6.66	7-10
Level-1	pH	12/20/2018	pH Units		Source Well	ELW142	0.01	7.17	7-3
Level-1	pH	12/20/2018	pH Units		Source Well	ELW134	0.01	7.23	7-10
Level-1	pH	12/20/2018	pH Units		Source Well	CC4	0.01	7.29	3-1
Level-1	pH	12/20/2018	pH Units		Source Well	ELW112	0.01	7.36	7-3
Level-1	pH	12/20/2018	pH Units		Source Well	NWH3	0.01	7.38	9-3
Level-1	pH	12/20/2018	pH Units		Source Well	NWH4	0.01	7.39	9-3
Level-1	pH	12/20/2018	pH Units		Source Well	NWH1	0.01	7.42	9-1
Level-1	pH	12/20/2018	pH Units		Source Well	ELW122	0.01	7.51	7-6
Level-1	pH	12/20/2018	pH Units		Source Well	ELW121	0.01	7.61	7-8
Level-1	Chloride	12/20/2018	mg/L		Source Well	ELW112	0.04	8.8	7-3
Level-1	Chloride	12/20/2018	mg/L		Source Well	ELW122	0.04	8.84	7-6
Level-1	Chloride	12/20/2018	mg/L		Source Well	CC4	0.04	8.95	3-1
Level-1	Sulfate	12/20/2018	mg/L		Source Well	ELW121	0.06	9.84	7-8
Level-1	Chloride	12/20/2018	mg/L		Source Well	ELW121	0.04	9.94	7-8
Level-1	Nitrate	12/19/2018	mg/L as N	U	Source Well	S-21-#10	0.01	0.01	10-1
Level-1	Nitrite	12/19/2018	mg/L as N	U	Source Well	S-21-#10	0.01	0.01	10-1
Level-1	Bromide	12/19/2018	mg/L	I	Source Well	CO-10	0.02	0.04	4-5
Level-1	Bromide	12/19/2018	mg/L	I	Source Well	CO-12A	0.02	0.04	4-3
Level-1	Bromide	12/19/2018	mg/L	I	Source Well	CO-30	0.02	0.04	4-5
Level-1	Bromide	12/19/2018	mg/L	I	Source Well	CO-7A	0.02	0.04	4-1
Level-1	Bromide	12/19/2018	mg/L	I	Source Well	CRLWD2	0.02	0.04	5-1
Level-1	Bromide	12/19/2018	mg/L	I	Source Well	NWH5	0.02	0.04	9-4
Level-1	Bromide	12/19/2018	mg/L	I	Source Well	S-21-#10	0.02	0.04	10-1
Level-1	Bromide	12/19/2018	mg/L	I	Source Well	S-21-#8	0.02	0.04	10-1
Level-1	Bromide	12/19/2018	mg/L	I	Source Well	CRLWD3	0.02	0.05	5-1
Level-1	Bromide	12/19/2018	mg/L	I	Source Well	NWH6	0.02	0.05	9-5
Level-1	Fluoride	12/19/2018	mg/L	I	Source Well	CRLWD1	0.01	0.06	5-1
Level-1	Sulfate	12/19/2018	mg/L	U	Source Well	CO-12A	0.06	0.06	4-3
Level-1	Bromide	12/19/2018	mg/L	I	Source Well	CRLWD1	0.02	0.07	5-1
Level-1	Fluoride	12/19/2018	mg/L	I	Source Well	CRLWD3	0.01	0.07	5-1
Level-1	Fluoride	12/19/2018	mg/L	I	Source Well	S-21-#10	0.01	0.07	10-1
Level-1	Fluoride	12/19/2018	mg/L	I	Source Well	S-21-#8	0.01	0.07	10-1
Level-1	Bromide	12/19/2018	mg/L	I	Source Well	CO-31	0.02	0.081	4-4
Level-1	Fluoride	12/19/2018	mg/L	I	Source Well	CO-32	0.01	0.084	4-1
Level-1	Bromide	12/19/2018	mg/L	I	Source Well	CO-32	0.02	0.089	4-1
Level-1	Fluoride	12/19/2018	mg/L	I	Source Well	CRLWD2	0.01	0.09	5-1
Level-1	Fluoride	12/19/2018	mg/L	I	Source Well	CO-10	0.01	0.1	4-5
Level-1	Fluoride	12/19/2018	mg/L	I	Source Well	CO-12A	0.01	0.1	4-3
Level-1	Fluoride	12/19/2018	mg/L	I	Source Well	CO-7A	0.01	0.11	4-1
Level-1	Fluoride	12/19/2018	mg/L	I	Source Well	NWH6	0.01	0.11	9-5

Level	Analyte	Date	Final Unit	Qualifier	Type	Sample Name	MDL	Result	Group
Level-1	Fluoride	12/19/2018	mg/L	I	Source Well	NWH5	0.01	0.12	9-4
Level-1	Fluoride	12/19/2018	mg/L	I	Source Well	CO-31	0.01	0.138	4-4
Level-1	Fluoride	12/19/2018	mg/L	I	Source Well	CO-30	0.01	0.14	4-5
Level-1	Sulfate	12/19/2018	mg/L	I	Source Well	S-21-#10	0.06	0.15	10-1
Level-1	Sulfate	12/19/2018	mg/L	I	Source Well	S-21-#8	0.06	0.15	10-1
Level-1	Sulfate	12/19/2018	mg/L	I	Source Well	CO-7A	0.06	0.58	4-1
Level-1	Sulfate	12/19/2018	mg/L	I	Source Well	CRLWD2	0.06	0.89	5-1
Level-1	Sulfate	12/19/2018	mg/L		Source Well	CO-30	0.06	1.29	4-5
Level-1	Sulfate	12/19/2018	mg/L		Source Well	NWH5	0.06	1.3	9-4
Level-1	Chloride	12/19/2018	mg/L		Source Well	NWH5	0.04	10.4	9-4
Level-1	Chloride	12/19/2018	mg/L		Source Well	CO-12A	0.04	10.6	4-3
Level-1	Chloride	12/19/2018	mg/L		Source Well	CRLWD2	0.04	10.6	5-1
Level-1	Chloride	12/19/2018	mg/L		Source Well	S-21-#10	0.04	10.9	10-1
Level-1	Chloride	12/19/2018	mg/L		Source Well	S-21-#8	0.04	11.1	10-1
Level-1	Chloride	12/19/2018	mg/L		Source Well	CO-32	0.04	11.3	4-1
Level-1	Chloride	12/19/2018	mg/L		Source Well	CO-7A	0.04	11.4	4-1
Level-1	Chloride	12/19/2018	mg/L		Source Well	CO-10	0.04	12.5	4-5
Level-1	Sulfate	12/19/2018	mg/L		Source Well	CRLWD3	0.06	2.39	5-1
Level-1	Sulfate	12/19/2018	mg/L		Source Well	NWH6	0.06	2.39	9-5
Level-1	Total Organic Carbon (TOC)	12/19/2018	mg/L		Source Well	CRLWD3	0.09	2.56	5-1
Level-1	Sulfate	12/19/2018	mg/L		Source Well	CO-10	0.06	2.64	4-5
Level-1	Total Organic Carbon (TOC)	12/19/2018	mg/L		Source Well	CRLWD2	0.09	2.64	5-1
Level-1	Total Organic Carbon (TOC)	12/19/2018	mg/L		Source Well	CO-10	0.09	2.9	4-5
Level-1	Chloride	12/19/2018	mg/L		Source Well	CRLWD3	0.04	20.2	5-1
Level-1	Chloride	12/19/2018	mg/L		Source Well	NWH6	0.04	20.4	9-5
Level-1	TDS	12/19/2018	mg/L		Source Well	S-21-#8	10	215	10-1
Level-1	TDS	12/19/2018	mg/L		Source Well	CRLWD2	10	222	5-1
Level-1	Temperature	12/19/2018	oC		Source Well	CRLWD1	0.1	23.8	5-1
Level-1	Temperature	12/19/2018	oC		Source Well	CRLWD3	0.1	23.9	5-1
Level-1	Temperature	12/19/2018	oC		Source Well	CRLWD2	0.1	24.4	5-1
Level-1	Temperature	12/19/2018	oC		Source Well	S-21-#10	0.1	24.6	10-1
Level-1	Temperature	12/19/2018	oC		Source Well	NWH5	0.1	24.7	9-4
Level-1	TDS	12/19/2018	mg/L		Source Well	CRLWD3	10	243	5-1
Level-1	TDS	12/19/2018	mg/L		Source Well	S-21-#10	10	246	10-1
Level-1	Temperature	12/19/2018	oC		Source Well	S-21-#8	0.1	25.2	10-1
Level-1	TDS	12/19/2018	mg/L		Source Well	NWH5	10	252	9-4
Level-1	TDS	12/19/2018	mg/L		Source Well	CRLWD1	10	276	5-1
Level-1	Chloride	12/19/2018	mg/L		Source Well	CRLWD1	0.04	29.1	5-1
Level-1	Total Organic Carbon (TOC)	12/19/2018	mg/L		Source Well	CRLWD1	0.09	3.02	5-1
Level-1	Total Organic Carbon (TOC)	12/19/2018	mg/L		Source Well	NWH6	0.09	3.02	9-5
Level-1	Total Organic Carbon (TOC)	12/19/2018	mg/L		Source Well	NWH5	0.09	3.17	9-4
Level-1	Total Organic Carbon (TOC)	12/19/2018	mg/L		Source Well	S-21-#8	0.09	3.75	10-1
Level-1	Conductivity	12/19/2018	umhos/cm		Source Well	CO-10	1	355	4-5
Level-1	Conductivity	12/19/2018	umhos/cm		Source Well	CO-32	1	396	4-1
Level-1	Conductivity	12/19/2018	umhos/cm		Source Well	CO-7A	1	399	4-1
Level-1	Total Organic Carbon (TOC)	12/19/2018	mg/L		Source Well	CO-12A	0.09	4	4-3
Level-1	Total Organic Carbon (TOC)	12/19/2018	mg/L		Source Well	S-21-#10	0.09	4.03	10-1
Level-1	Total Organic Carbon (TOC)	12/19/2018	mg/L		Source Well	CO-31	0.09	4.19	4-4
Level-1	Total Organic Carbon (TOC)	12/19/2018	mg/L		Source Well	CO-30	0.09	4.21	4-5
Level-1	Sulfate	12/19/2018	mg/L		Source Well	CRLWD1	0.06	4.33	5-1
Level-1	Total Organic Carbon (TOC)	12/19/2018	mg/L		Source Well	CO-32	0.09	4.56	4-1
Level-1	Conductivity	12/19/2018	umhos/cm		Source Well	S-21-#8	1	403	10-1
Level-1	Conductivity	12/19/2018	umhos/cm		Source Well	CRLWD2	1	411	5-1

Level	Analyte	Date	Final Unit	Qualifier	Type	Sample Name	MDL	Result	Group
Level-1	Conductivity	12/19/2018	umhos/cm		Source Well	CO-12A	1	424	4-3
Level-1	Conductivity	12/19/2018	umhos/cm		Source Well	NWH5	1	434	9-4
Level-1	Conductivity	12/19/2018	umhos/cm		Source Well	CRLWD3	1	436	5-1
Level-1	Conductivity	12/19/2018	umhos/cm		Source Well	S-21-#10	1	439	10-1
Level-1	Conductivity	12/19/2018	umhos/cm		Source Well	CO-30	1	442	4-5
Level-1	Conductivity	12/19/2018	umhos/cm		Source Well	CO-31	1	475	4-4
Level-1	Conductivity	12/19/2018	umhos/cm		Source Well	NWH6	1	479	9-5
Level-1	Conductivity	12/19/2018	umhos/cm		Source Well	CRLWD1	1	485	5-1
Level-1	Total Organic Carbon (TOC)	12/19/2018	mg/L		Source Well	CO-7A	0.09	5.46	4-1
Level-1	pH	12/19/2018	pH Units		Source Well	CO-32	0.01	6.94	4-1
Level-1	pH	12/19/2018	pH Units		Source Well	CRLWD1	0.01	7.12	5-1
Level-1	pH	12/19/2018	pH Units		Source Well	NWH6	0.01	7.21	9-5
Level-1	pH	12/19/2018	pH Units		Source Well	CO-30	0.01	7.27	4-5
Level-1	pH	12/19/2018	pH Units		Source Well	CRLWD3	0.01	7.27	5-1
Level-1	pH	12/19/2018	pH Units		Source Well	S-21-#10	0.01	7.27	10-1
Level-1	pH	12/19/2018	pH Units		Source Well	CO-12A	0.01	7.28	4-3
Level-1	pH	12/19/2018	pH Units		Source Well	CO-31	0.01	7.33	4-4
Level-1	pH	12/19/2018	pH Units		Source Well	CO-7A	0.01	7.33	4-1
Level-1	pH	12/19/2018	pH Units		Source Well	S-21-#8	0.01	7.33	10-1
Level-1	pH	12/19/2018	pH Units		Source Well	CO-10	0.01	7.36	4-5
Level-1	pH	12/19/2018	pH Units		Source Well	NWH5	0.01	7.37	9-4
Level-1	pH	12/19/2018	pH Units		Source Well	CRLWD2	0.01	7.44	5-1
Level-1	Sulfate	12/19/2018	mg/L		Source Well	CO-31	0.06	7.6	4-4
Level-1	Sulfate	12/19/2018	mg/L		Source Well	CO-32	0.06	8.36	4-1
Level-1	Chloride	12/19/2018	mg/L		Source Well	CO-30	0.04	9.36	4-5
Level-1	Chloride	12/19/2018	mg/L		Source Well	CO-31	0.04	9.48	4-4
Level-1	Fluoride	12/18/2018	mg/L	U	Source Well	CB1	0.01	0.01	2-9
Level-1	Fluoride	12/18/2018	mg/L	U	Source Well	CB7	0.01	0.01	2-8
Level-1	Fluoride	12/18/2018	mg/L	U	Source Well	ELW110	0.01	0.01	7-6
Level-1	Fluoride	12/18/2018	mg/L	U	Source Well	ELW113	0.01	0.01	7-6
Level-1	Fluoride	12/18/2018	mg/L	U	Source Well	ELW137	0.01	0.01	7-6
Level-1	Nitrate	12/18/2018	mg/L as N	U	Source Well	ELW110	0.01	0.01	7-6
Level-1	Nitrate	12/18/2018	mg/L as N	U	Source Well	ELW113	0.01	0.01	7-6
Level-1	Nitrate	12/18/2018	mg/L as N	U	Source Well	ELW137	0.01	0.01	7-6
Level-1	Nitrite	12/18/2018	mg/L as N	U	Source Well	ELW110	0.01	0.01	7-6
Level-1	Nitrite	12/18/2018	mg/L as N	U	Source Well	ELW113	0.01	0.01	7-6
Level-1	Nitrite	12/18/2018	mg/L as N	U	Source Well	ELW137	0.01	0.01	7-6
Level-1	Bromide	12/18/2018	mg/L	I	Source Well	CB1	0.02	0.03	2-9
Level-1	Bromide	12/18/2018	mg/L	I	Source Well	CB10	0.02	0.03	2-1
Level-1	Bromide	12/18/2018	mg/L	I	Source Well	CB2	0.02	0.03	2-8
Level-1	Bromide	12/18/2018	mg/L	I	Source Well	CB7	0.02	0.03	2-8
Level-1	Bromide	12/18/2018	mg/L	I	Source Well	CY11	0.02	0.03	6-1
Level-1	Bromide	12/18/2018	mg/L	I	Source Well	CY8	0.02	0.03	6-2
Level-1	Bromide	12/18/2018	mg/L	I	Source Well	ELW109	0.02	0.04	7-6
Level-1	Bromide	12/18/2018	mg/L	I	Source Well	ELW110	0.02	0.04	7-6
Level-1	Bromide	12/18/2018	mg/L	I	Source Well	ELW113	0.02	0.04	7-6
Level-1	Bromide	12/18/2018	mg/L	I	Source Well	ELW137	0.02	0.04	7-6
Level-1	Bromide	12/18/2018	mg/L	I	Source Well	ELW140	0.02	0.04	7-3
Level-1	Bromide	12/18/2018	mg/L	I	Source Well	ELW141	0.02	0.04	7-3
Level-1	Fluoride	12/18/2018	mg/L	I	Source Well	CB10	0.01	0.04	2-1
Level-1	Fluoride	12/18/2018	mg/L	I	Source Well	CB2	0.01	0.04	2-8
Level-1	Bromide	12/18/2018	mg/L	I	Source Well	ELW104	0.02	0.05	7-1
Level-1	Ortho P	12/18/2018	mg/L as P	I	Source Well	ELW113	0.02	0.06	7-6
Level-1	Sulfate	12/18/2018	mg/L	U	Source Well	CB1	0.06	0.06	2-9
Level-1	Fluoride	12/18/2018	mg/L	I	Source Well	CY11	0.01	0.1	6-1
Level-1	Fluoride	12/18/2018	mg/L	I	Source Well	ELW104	0.01	0.12	7-1
Level-1	Fluoride	12/18/2018	mg/L	I	Source Well	ELW109	0.01	0.12	7-6
Level-1	Fluoride	12/18/2018	mg/L	I	Source Well	ELW140	0.01	0.12	7-3
Level-1	Fluoride	12/18/2018	mg/L	I	Source Well	ELW141	0.01	0.12	7-3

Level	Analyte	Date	Final Unit	Qualifier	Type	Sample Name	MDL	Result	Group
Level-1	Fluoride	12/18/2018	mg/L	I	Source Well	CY8	0.01	0.13	6-2
Level-1	Sulfate	12/18/2018	mg/L	I	Source Well	CB2	0.06	0.19	2-8
Level-1	Sulfate	12/18/2018	mg/L	I	Source Well	ELW113	0.06	0.36	7-6
Level-1	Sulfate	12/18/2018	mg/L	I	Source Well	CB7	0.06	0.44	2-8
Level-1	Sulfate	12/18/2018	mg/L	I	Source Well	CY11	0.06	0.75	6-1
Level-1	Sulfate	12/18/2018	mg/L	I	Source Well	ELW110	0.06	0.81	7-6
Level-1	Sulfate	12/18/2018	mg/L	I	Source Well	CB10	0.06	0.91	2-1
Level-1	Sulfate	12/18/2018	mg/L		Source Well	CY8	0.06	1.01	6-2
Level-1	Sulfate	12/18/2018	mg/L		Source Well	ELW140	0.06	1.04	7-3
Level-1	Sulfate	12/18/2018	mg/L		Source Well	ELW141	0.06	1.05	7-3
Level-1	Sulfate	12/18/2018	mg/L		Source Well	ELW109	0.06	1.39	7-6
Level-1	Sulfate	12/18/2018	mg/L		Source Well	ELW137	0.06	1.7	7-6
Level-1	Total Organic Carbon (TOC)	12/18/2018	mg/L		Source Well	CY8	0.09	1.83	6-2
Level-1	Total Organic Carbon (TOC)	12/18/2018	mg/L		Source Well	CY11	0.09	1.92	6-1
Level-1	Chloride	12/18/2018	mg/L		Source Well	ELW141	0.04	10.1	7-3
Level-1	Chloride	12/18/2018	mg/L		Source Well	ELW140	0.04	11.7	7-3
Level-1	Total Organic Carbon (TOC)	12/18/2018	mg/L		Source Well	CB10	0.09	2.18	2-1
Level-1	Total Organic Carbon (TOC)	12/18/2018	mg/L		Source Well	CB2	0.09	2.52	2-8
Level-1	Total Organic Carbon (TOC)	12/18/2018	mg/L		Source Well	CB1	0.09	2.53	2-9
Level-1	Total Organic Carbon (TOC)	12/18/2018	mg/L		Source Well	CB7	0.09	2.65	2-8
Level-1	TDS	12/18/2018	mg/L		Source Well	CB10	10	200	2-1
Level-1	TDS	12/18/2018	mg/L		Source Well	CB2	10	205	2-8
Level-1	TDS	12/18/2018	mg/L		Source Well	CB7	10	211	2-8
Level-1	TDS	12/18/2018	mg/L		Source Well	ELW137	10	217	7-6
Level-1	TDS	12/18/2018	mg/L		Source Well	CB1	10	221	2-9
Level-1	TDS	12/18/2018	mg/L		Source Well	CY8	10	221	6-2
Level-1	Temperature	12/18/2018	oC		Source Well	CB7	0.1	23.4	2-8
Level-1	Temperature	12/18/2018	oC		Source Well	CB1	0.1	23.6	2-9
Level-1	TDS	12/18/2018	mg/L		Source Well	ELW110	10	235	7-6
Level-1	Temperature	12/18/2018	oC		Source Well	CB10	0.1	24.1	2-1
Level-1	Temperature	12/18/2018	oC		Source Well	CB2	0.1	24.2	2-8
Level-1	TDS	12/18/2018	mg/L		Source Well	ELW113	10	242	7-6
Level-1	Temperature	12/18/2018	oC		Source Well	CY11	0.1	25	6-1
Level-1	Temperature	12/18/2018	oC		Source Well	CY8	0.1	25.9	6-2
Level-1	TDS	12/18/2018	mg/L		Source Well	ELW141	10	256	7-3
Level-1	TDS	12/18/2018	mg/L		Source Well	CY11	10	267	6-1
Level-1	TDS	12/18/2018	mg/L		Source Well	ELW140	10	269	7-3
Level-1	Sulfate	12/18/2018	mg/L		Source Well	ELW104	0.06	3.2	7-1
Level-1	Total Organic Carbon (TOC)	12/18/2018	mg/L		Source Well	ELW109	0.09	3.96	7-6
Level-1	Total Organic Carbon (TOC)	12/18/2018	mg/L		Source Well	ELW110	0.09	4.03	7-6
Level-1	Total Organic Carbon (TOC)	12/18/2018	mg/L		Source Well	ELW113	0.09	4.18	7-6
Level-1	Total Organic Carbon (TOC)	12/18/2018	mg/L		Source Well	ELW137	0.09	4.26	7-6
Level-1	Total Organic Carbon (TOC)	12/18/2018	mg/L		Source Well	ELW104	0.09	4.45	7-1
Level-1	Total Organic Carbon (TOC)	12/18/2018	mg/L		Source Well	ELW140	0.09	4.8	7-3
Level-1	Total Organic Carbon (TOC)	12/18/2018	mg/L		Source Well	ELW141	0.09	4.85	7-3
Level-1	Conductivity	12/18/2018	umhos/cm		Source Well	CB10	1	408	2-1
Level-1	Conductivity	12/18/2018	umhos/cm		Source Well	ELW104	1	408	7-1
Level-1	Conductivity	12/18/2018	umhos/cm		Source Well	CY8	1	420	6-2
Level-1	Conductivity	12/18/2018	umhos/cm		Source Well	CB7	1	421	2-8
Level-1	Conductivity	12/18/2018	umhos/cm		Source Well	ELW109	1	429	7-6
Level-1	Conductivity	12/18/2018	umhos/cm		Source Well	ELW110	1	430	7-6
Level-1	Conductivity	12/18/2018	umhos/cm		Source Well	ELW113	1	430	7-6

Level	Analyte	Date	Final Unit	Qualifier	Type	Sample Name	MDL	Result	Group
Level-1	Conductivity	12/18/2018	umhos/cm		Source Well	CB2	1	438	2-8
Level-1	Conductivity	12/18/2018	umhos/cm		Source Well	ELW137	1	445	7-6
Level-1	Conductivity	12/18/2018	umhos/cm		Source Well	CB1	1	447	2-9
Level-1	Conductivity	12/18/2018	umhos/cm		Source Well	ELW141	1	469	7-3
Level-1	Conductivity	12/18/2018	umhos/cm		Source Well	ELW140	1	471	7-3
Level-1	Conductivity	12/18/2018	umhos/cm		Source Well	CY11	1	531	6-1
Level-1	Chloride	12/18/2018	mg/L		Source Well	CB1	0.04	6.87	2-9
Level-1	Chloride	12/18/2018	mg/L		Source Well	CB7	0.04	6.89	2-8
Level-1	Chloride	12/18/2018	mg/L		Source Well	CB2	0.04	6.93	2-8
Level-1	pH	12/18/2018	pH Units		Source Well	CB1	0.01	7	2-9
Level-1	Chloride	12/18/2018	mg/L		Source Well	CY8	0.04	7.01	6-2
Level-1	Chloride	12/18/2018	mg/L		Source Well	CB10	0.04	7.06	2-1
Level-1	pH	12/18/2018	pH Units		Source Well	CB7	0.01	7.21	2-8
Level-1	pH	12/18/2018	pH Units		Source Well	CY11	0.01	7.21	6-1
Level-1	pH	12/18/2018	pH Units		Source Well	CB2	0.01	7.24	2-8
Level-1	pH	12/18/2018	pH Units		Source Well	ELW140	0.01	7.24	7-3
Level-1	pH	12/18/2018	pH Units		Source Well	ELW104	0.01	7.28	7-1
Level-1	pH	12/18/2018	pH Units		Source Well	CB10	0.01	7.31	2-1
Level-1	pH	12/18/2018	pH Units		Source Well	ELW141	0.01	7.31	7-3
Level-1	pH	12/18/2018	pH Units		Source Well	ELW137	0.01	7.34	7-6
Level-1	pH	12/18/2018	pH Units		Source Well	ELW110	0.01	7.38	7-6
Level-1	pH	12/18/2018	pH Units		Source Well	ELW113	0.01	7.38	7-6
Level-1	pH	12/18/2018	pH Units		Source Well	ELW109	0.01	7.39	7-6
Level-1	pH	12/18/2018	pH Units		Source Well	CY8	0.01	7.47	6-2
Level-1	Chloride	12/18/2018	mg/L		Source Well	CY11	0.04	8.49	6-1
Level-1	Chloride	12/18/2018	mg/L		Source Well	ELW104	0.04	8.58	7-1
Level-1	Chloride	12/18/2018	mg/L		Source Well	ELW109	0.04	8.81	7-6
Level-1	Chloride	12/18/2018	mg/L		Source Well	ELW113	0.04	8.82	7-6
Level-1	Chloride	12/18/2018	mg/L		Source Well	ELW110	0.04	9.15	7-6
Level-1	Chloride	12/18/2018	mg/L		Source Well	ELW137	0.04	9.38	7-6
Level-1	Fluoride	12/17/2018	mg/L	U	Source Well	CC10	0.01	0.01	3-4
Level-1	Fluoride	12/17/2018	mg/L	U	Source Well	CC11	0.01	0.01	3-5
Level-1	Fluoride	12/17/2018	mg/L	U	Source Well	CC2	0.01	0.01	3-2
Level-1	Fluoride	12/17/2018	mg/L	U	Source Well	CC6	0.01	0.01	3-3
Level-1	Fluoride	12/17/2018	mg/L	U	Source Well	CC9	0.01	0.01	3-2
Level-1	Fluoride	12/17/2018	mg/L	U	Source Well	CY4	0.01	0.01	6-1
Level-1	Nitrate	12/17/2018	mg/L as N	U	Source Well	CY9	0.01	0.01	6-1
Level-1	Nitrite	12/17/2018	mg/L as N	U	Source Well	CY9	0.01	0.01	6-1
Level-1	Fluoride	12/17/2018	mg/L	U	Source Well	CC1	0.01	0.01	3-1
Level-1	Ortho P	12/17/2018	mg/L as P	U	Source Well	CY9	0.02	0.02	6-1
Level-1	Ortho P	12/17/2018	mg/L as P	U	Source Well	SCH1	0.02	0.02	11-1
Level-1	Ortho P	12/17/2018	mg/L as P	U	Source Well	SCH14	0.02	0.02	11-8
Level-1	Ortho P	12/17/2018	mg/L as P	U	Source Well	SCH8	0.02	0.02	11-2
Level-1	Bromide	12/17/2018	mg/L	I	Source Well	CC2	0.02	0.03	3-2
Level-1	Bromide	12/17/2018	mg/L	I	Source Well	CC6	0.02	0.03	3-3
Level-1	Bromide	12/17/2018	mg/L	I	Source Well	CY4	0.02	0.03	6-1
Level-1	Bromide	12/17/2018	mg/L	I	Source Well	CY9	0.02	0.03	6-1
Level-1	Bromide	12/17/2018	mg/L	I	Source Well	CC10	0.02	0.04	3-4
Level-1	Bromide	12/17/2018	mg/L	I	Source Well	CC11	0.02	0.04	3-5
Level-1	Bromide	12/17/2018	mg/L	I	Source Well	CC3	0.02	0.04	3-3
Level-1	Bromide	12/17/2018	mg/L	I	Source Well	CC9	0.02	0.04	3-2
Level-1	Bromide	12/17/2018	mg/L	I	Source Well	CC1	0.02	0.04	3-1
Level-1	Bromide	12/17/2018	mg/L	I	Source Well	SCH1	0.02	0.05	11-1
Level-1	Bromide	12/17/2018	mg/L	I	Source Well	SCH14	0.02	0.05	11-8
Level-1	Bromide	12/17/2018	mg/L	I	Source Well	SCH8	0.02	0.06	11-2
Level-1	Fluoride	12/17/2018	mg/L	I	Source Well	CC3	0.01	0.11	3-3
Level-1	Fluoride	12/17/2018	mg/L	I	Source Well	CY9	0.01	0.12	6-1
Level-1	Fluoride	12/17/2018	mg/L	I	Source Well	SCH8	0.01	0.36	11-2
Level-1	Sulfate	12/17/2018	mg/L	I	Source Well	CY9	0.06	0.37	6-1
Level-1	Fluoride	12/17/2018	mg/L	I	Source Well	SCH14	0.01	0.39	11-8

Level	Analyte	Date	Final Unit	Qualifier	Type	Sample Name	MDL	Result	Group
Level-1	Fluoride	12/17/2018	mg/L		Source Well	SCH1	0.01	0.57	11-1
Level-1	Sulfate	12/17/2018	mg/L	I	Source Well	CY4	0.06	0.58	6-1
Level-1	Total Organic Carbon (TOC)	12/17/2018	mg/L		Source Well	SCH1	0.09	1.37	11-1
Level-1	Total Organic Carbon (TOC)	12/17/2018	mg/L		Source Well	SCH14	0.09	1.42	11-8
Level-1	Total Organic Carbon (TOC)	12/17/2018	mg/L		Source Well	CY4	0.09	1.5	6-1
Level-1	Total Organic Carbon (TOC)	12/17/2018	mg/L		Source Well	SCH8	0.09	1.6	11-2
Level-1	Total Organic Carbon (TOC)	12/17/2018	mg/L		Source Well	CY9	0.09	1.87	6-1
Level-1	Sulfate	12/17/2018	mg/L		Source Well	SCH1	0.06	113	11-1
Level-1	Sulfate	12/17/2018	mg/L		Source Well	SCH14	0.06	113	11-8
Level-1	Sulfate	12/17/2018	mg/L		Source Well	CC6	0.06	12	3-3
Level-1	Chloride	12/17/2018	mg/L		Source Well	SCH14	0.04	12.1	11-8
Level-1	Chloride	12/17/2018	mg/L		Source Well	SCH1	0.04	12.5	11-1
Level-1	Chloride	12/17/2018	mg/L		Source Well	SCH8	0.04	13.8	11-2
Level-1	Sulfate	12/17/2018	mg/L		Source Well	CC11	0.06	18	3-5
Level-1	Total Organic Carbon (TOC)	12/17/2018	mg/L		Source Well	CC2	0.09	2.37	3-2
Level-1	Total Organic Carbon (TOC)	12/17/2018	mg/L		Source Well	CC1	0.09	2.56	3-1
Level-1	Total Organic Carbon (TOC)	12/17/2018	mg/L		Source Well	CC9	0.09	2.64	3-2
Level-1	Total Organic Carbon (TOC)	12/17/2018	mg/L		Source Well	CC6	0.09	2.93	3-3
Level-1	Sulfate	12/17/2018	mg/L		Source Well	CC3	0.06	20.6	3-3
Level-1	TDS	12/17/2018	mg/L		Source Well	CY4	10	209	6-1
Level-1	TDS	12/17/2018	mg/L		Source Well	CC1	10	227	3-1
Level-1	Temperature	12/17/2018	oC		Source Well	CC11	0.1	23.1	3-5
Level-1	Temperature	12/17/2018	oC		Source Well	CC10	0.1	23.2	3-4
Level-1	Temperature	12/17/2018	oC		Source Well	CC1	0.1	23.7	3-1
Level-1	Temperature	12/17/2018	oC		Source Well	CC3	0.1	23.8	3-3
Level-1	TDS	12/17/2018	mg/L		Source Well	CC2	10	234	3-2
Level-1	TDS	12/17/2018	mg/L		Source Well	SCH8	10	236	11-2
Level-1	Temperature	12/17/2018	oC		Source Well	CC6	0.1	24.4	3-3
Level-1	Temperature	12/17/2018	oC		Source Well	CC9	0.1	24.4	3-2
Level-1	Temperature	12/17/2018	oC		Source Well	CC2	0.1	24.6	3-2
Level-1	Temperature	12/17/2018	oC		Source Well	CY4	0.1	24.7	6-1
Level-1	TDS	12/17/2018	mg/L		Source Well	CY9	10	244	6-1
Level-1	Temperature	12/17/2018	oC		Source Well	CY9	0.1	25.4	6-1
Level-1	TDS	12/17/2018	mg/L		Source Well	CC6	10	258	3-3
Level-1	Temperature	12/17/2018	oC		Source Well	SCH1	0.1	26.4	11-1
Level-1	Temperature	12/17/2018	oC		Source Well	SCH8	0.1	26.4	11-2
Level-1	Temperature	12/17/2018	oC		Source Well	SCH14	0.1	26.5	11-8
Level-1	Sulfate	12/17/2018	mg/L		Source Well	CC9	0.06	27.2	3-2
Level-1	TDS	12/17/2018	mg/L		Source Well	CC3	10	275	3-3
Level-1	TDS	12/17/2018	mg/L		Source Well	CC9	10	277	3-2
Level-1	Sulfate	12/17/2018	mg/L		Source Well	CC10	0.06	28.9	3-4
Level-1	TDS	12/17/2018	mg/L		Source Well	CC11	10	280	3-5
Level-1	TDS	12/17/2018	mg/L		Source Well	CC10	10	298	3-4
Level-1	Total Organic Carbon (TOC)	12/17/2018	mg/L		Source Well	CC3	0.09	3	3-3
Level-1	Sulfate	12/17/2018	mg/L		Source Well	CC1	0.06	3.59	3-1
Level-1	Total Organic Carbon (TOC)	12/17/2018	mg/L		Source Well	CC10	0.09	3.91	3-4
Level-1	Sulfate	12/17/2018	mg/L		Source Well	SCH8	0.06	31.3	11-2
Level-1	TDS	12/17/2018	mg/L		Source Well	SCH14	10	341	11-8
Level-1	TDS	12/17/2018	mg/L		Source Well	SCH1	10	342	11-1
Level-1	Total Organic Carbon (TOC)	12/17/2018	mg/L		Source Well	CC11	0.09	4.45	3-5
Level-1	Conductivity	12/17/2018	umhos/cm		Source Well	CY4	1	418	6-1
Level-1	Conductivity	12/17/2018	umhos/cm		Source Well	SCH8	1	483	11-2
Level-1	Conductivity	12/17/2018	umhos/cm		Source Well	CC1	1	485	3-1

Level	Analyte	Date	Final Unit	Qualifier	Type	Sample Name	MDL	Result	Group
Level-1	Conductivity	12/17/2018	umhos/cm		Source Well	CC2	1	488	3-2
Level-1	Conductivity	12/17/2018	umhos/cm		Source Well	CY9	1	493	6-1
Level-1	Sulfate	12/17/2018	mg/L		Source Well	CC2	0.06	5.81	3-2
Level-1	Conductivity	12/17/2018	umhos/cm		Source Well	CC6	1	522	3-3
Level-1	Conductivity	12/17/2018	umhos/cm		Source Well	CC9	1	547	3-2
Level-1	Conductivity	12/17/2018	umhos/cm		Source Well	CC11	1	548	3-5
Level-1	Conductivity	12/17/2018	umhos/cm		Source Well	CC3	1	551	3-3
Level-1	Conductivity	12/17/2018	umhos/cm		Source Well	CC10	1	576	3-4
Level-1	Conductivity	12/17/2018	umhos/cm		Source Well	SCH1	1	613	11-1
Level-1	Conductivity	12/17/2018	umhos/cm		Source Well	SCH14	1	614	11-8
Level-1	pH	12/17/2018	pH Units		Source Well	CC10	0.01	7.13	3-4
Level-1	pH	12/17/2018	pH Units		Source Well	CC11	0.01	7.23	3-5
Level-1	pH	12/17/2018	pH Units		Source Well	CC3	0.01	7.27	3-3
Level-1	pH	12/17/2018	pH Units		Source Well	CY9	0.01	7.27	6-1
Level-1	pH	12/17/2018	pH Units		Source Well	CC9	0.01	7.28	3-2
Level-1	pH	12/17/2018	pH Units		Source Well	CC6	0.01	7.32	3-3
Level-1	pH	12/17/2018	pH Units		Source Well	CC1	0.01	7.32	3-1
Level-1	pH	12/17/2018	pH Units		Source Well	CY4	0.01	7.35	6-1
Level-1	pH	12/17/2018	pH Units		Source Well	CC2	0.01	7.39	3-2
Level-1	pH	12/17/2018	pH Units		Source Well	SCH1	0.01	7.45	11-1
Level-1	pH	12/17/2018	pH Units		Source Well	SCH14	0.01	7.47	11-8
Level-1	pH	12/17/2018	pH Units		Source Well	SCH8	0.01	7.47	11-2
Level-1	Chloride	12/17/2018	mg/L		Source Well	CC2	0.04	7.96	3-2
Level-1	Chloride	12/17/2018	mg/L		Source Well	CY4	0.04	8.1	6-1
Level-1	Chloride	12/17/2018	mg/L		Source Well	CC6	0.04	8.26	3-3
Level-1	Chloride	12/17/2018	mg/L		Source Well	CC3	0.04	8.67	3-3
Level-1	Chloride	12/17/2018	mg/L		Source Well	CC1	0.04	8.72	3-1
Level-1	Chloride	12/17/2018	mg/L		Source Well	CC11	0.04	8.93	3-5
Level-1	Chloride	12/17/2018	mg/L		Source Well	CY9	0.04	9.00	6-1
Level-1	Chloride	12/17/2018	mg/L		Source Well	CC9	0.04	9.08	3-2
Level-1	Chloride	12/17/2018	mg/L		Source Well	CC10	0.04	9.33	3-4
Level-1	Fluoride	12/13/2018	mg/L	U	Source Well	CC10	0.01	0.01	3-4
Level-1	Fluoride	12/13/2018	mg/L	U	Source Well	CC12	0.01	0.01	3-3
Level-1	Fluoride	12/13/2018	mg/L	U	Source Well	CC4	0.01	0.01	3-1
Level-1	Fluoride	12/13/2018	mg/L	U	Source Well	CC5	0.01	0.01	3-1
Level-1	Fluoride	12/13/2018	mg/L	U	Source Well	CC6	0.01	0.01	3-3
Level-1	Fluoride	12/13/2018	mg/L	U	Source Well	CC8	0.01	0.01	3-2
Level-1	Fluoride	12/13/2018	mg/L	U	Source Well	CC9	0.01	0.01	3-2
Level-1	Fluoride	12/13/2018	mg/L	U	Source Well	ELW137	0.01	0.01	7-6
Level-1	Nitrate	12/13/2018	mg/L	U	Source Well	CC2	0.01	0.01	3-2
Level-1	Nitrite	12/13/2018	mg/L	U	Source Well	CC2	0.01	0.01	3-2
Level-1	Ortho P	12/13/2018	mg/L	U	Source Well	CC2	0.02	0.02	3-2
Level-1	Bromide	12/13/2018	mg/L	I	Source Well	CC2	0.02	0.03	3-2
Level-1	Bromide	12/13/2018	mg/L	I	Source Well	CC8	0.02	0.03	3-2
Level-1	Bromide	12/13/2018	mg/L	I	Source Well	CC1	0.02	0.04	3-1
Level-1	Bromide	12/13/2018	mg/L	I	Source Well	CC10	0.02	0.04	3-4
Level-1	Bromide	12/13/2018	mg/L	I	Source Well	CC12	0.02	0.04	3-3
Level-1	Bromide	12/13/2018	mg/L	I	Source Well	CC4	0.02	0.04	3-1
Level-1	Bromide	12/13/2018	mg/L	I	Source Well	CC5	0.02	0.04	3-1
Level-1	Bromide	12/13/2018	mg/L	I	Source Well	CC6	0.02	0.04	3-3
Level-1	Bromide	12/13/2018	mg/L	I	Source Well	CC9	0.02	0.04	3-2
Level-1	Bromide	12/13/2018	mg/L	I	Source Well	ELW137	0.02	0.04	7-6
Level-1	Fluoride	12/13/2018	mg/L	I	Source Well	CC1	0.01	0.12	3-1
Level-1	Fluoride	12/13/2018	mg/L	I	Source Well	CC2	0.01	0.13	3-2
Level-1	Sulfate	12/13/2018	mg/L		Source Well	ELW137	0.06	1.91	7-6
Level-1	Total Organic Carbon (TOC)	12/13/2018	mg/L		Source Well	CC8	0.09	2.12	3-2
Level-1	Total Organic Carbon (TOC)	12/13/2018	mg/L		Source Well	CC2	0.09	2.33	3-2
Level-1	Total Organic Carbon (TOC)	12/13/2018	mg/L		Source Well	CC9	0.09	2.45	3-2

Level	Analyte	Date	Final Unit	Qualifier	Type	Sample Name	MDL	Result	Group
Level-1	Total Organic Carbon (TOC)	12/13/2018	mg/L		Source Well	CC1	0.09	2.59	3-1
Level-1	Total Organic Carbon (TOC)	12/13/2018	mg/L		Source Well	CC5	0.09	2.81	3-1
Level-1	Temperature	12/13/2018	oC		Source Well	CC12	0.1	23.2	3-3
Level-1	Sulfate	12/13/2018	mg/L		Source Well	CC12	0.06	24.4	3-3
Level-1	Sulfate	12/13/2018	mg/L		Source Well	CC5	0.06	24.9	3-1
Level-1	Sulfate	12/13/2018	mg/L		Source Well	CC10	0.06	25.7	3-4
Level-1	Sulfate	12/13/2018	mg/L		Source Well	CC4	0.06	25.9	3-1
Level-1	Sulfate	12/13/2018	mg/L		Source Well	CC9	0.06	28.4	3-2
Level-1	TDS	12/13/2018	mg/L		Source Well	CC12	10	283	3-3
Level-1	Total Organic Carbon (TOC)	12/13/2018	mg/L		Source Well	CC6	0.09	3.1	3-3
Level-1	Total Organic Carbon (TOC)	12/13/2018	mg/L		Source Well	CC4	0.09	3.25	3-1
Level-1	Sulfate	12/13/2018	mg/L		Source Well	CC1	0.06	3.31	3-1
Level-1	Total Organic Carbon (TOC)	12/13/2018	mg/L		Source Well	CC10	0.09	3.71	3-4
Level-1	Total Organic Carbon (TOC)	12/13/2018	mg/L		Source Well	CC12	0.09	3.88	3-3
Level-1	Sulfate	12/13/2018	mg/L		Source Well	CC8	0.06	38.4	3-2
Level-1	Total Organic Carbon (TOC)	12/13/2018	mg/L		Source Well	ELW137	0.09	4.29	7-6
Level-1	Conductivity	12/13/2018	umhos/cm		Source Well	ELW137	1	440	7-6
Level-1	Conductivity	12/13/2018	umhos/cm		Source Well	CC1	1	487	3-1
Level-1	Conductivity	12/13/2018	umhos/cm		Source Well	CC2	1	491	3-2
Level-1	Sulfate	12/13/2018	mg/L		Source Well	CC2	0.06	5.99	3-2
Level-1	Conductivity	12/13/2018	umhos/cm		Source Well	CC6	1	525	3-3
Level-1	Conductivity	12/13/2018	umhos/cm		Source Well	CC5	1	552	3-1
Level-1	Conductivity	12/13/2018	umhos/cm		Source Well	CC9	1	554	3-2
Level-1	Conductivity	12/13/2018	umhos/cm		Source Well	CC8	1	562	3-2
Level-1	Conductivity	12/13/2018	umhos/cm		Source Well	CC10	1	564	3-4
Level-1	Conductivity	12/13/2018	umhos/cm		Source Well	CC4	1	573	3-1
Level-1	Conductivity	12/13/2018	umhos/cm		Source Well	CC12	1	589	3-3
Level-1	pH	12/13/2018	pH Units		Source Well	CC12	0.01	7.19	3-3
Level-1	pH	12/13/2018	pH Units		Source Well	CC10	0.01	7.25	3-4
Level-1	pH	12/13/2018	pH Units		Source Well	CC4	0.01	7.27	3-1
Level-1	pH	12/13/2018	pH Units		Source Well	CC5	0.01	7.28	3-1
Level-1	pH	12/13/2018	pH Units		Source Well	CC1	0.01	7.3	3-1
Level-1	pH	12/13/2018	pH Units		Source Well	CC6	0.01	7.34	3-3
Level-1	pH	12/13/2018	pH Units		Source Well	CC9	0.01	7.34	3-2
Level-1	pH	12/13/2018	pH Units		Source Well	CC8	0.01	7.35	3-2
Level-1	pH	12/13/2018	pH Units		Source Well	CC2	0.01	7.4	3-2
Level-1	pH	12/13/2018	pH Units		Source Well	ELW137	0.01	7.43	7-6
Level-1	Chloride	12/13/2018	mg/L		Source Well	CC2	0.04	7.96	3-2
Level-1	Chloride	12/13/2018	mg/L		Source Well	CC8	0.04	8.24	3-2
Level-1	Chloride	12/13/2018	mg/L		Source Well	CC6	0.04	8.33	3-3
Level-1	Chloride	12/13/2018	mg/L		Source Well	CC5	0.04	8.4	3-1
Level-1	Chloride	12/13/2018	mg/L		Source Well	CC1	0.04	8.72	3-1
Level-1	Chloride	12/13/2018	mg/L		Source Well	CC4	0.04	8.9	3-1
Level-1	Chloride	12/13/2018	mg/L		Source Well	CC10	0.04	9.00	3-4
Level-1	Chloride	12/13/2018	mg/L		Source Well	CC9	0.04	9.21	3-2
Level-1	Chloride	12/13/2018	mg/L		Source Well	ELW137	0.04	9.36	7-6
Level-1	Sulfate	12/13/2018	mg/L		Source Well	CC6	0.06	9.54	3-3
Level-1	Chloride	12/13/2018	mg/L		Source Well	CC12	0.04	9.9	3-3
Level-1	Bromide	12/12/2018	mg/L		Source Well	CB12	0.02	0.02	2-6
Level-1	Bromide	12/12/2018	mg/L		Source Well	CB16	0.02	0.02	2-4
Level-1	Bromide	12/12/2018	mg/L		Source Well	CB17	0.02	0.02	2-3
Level-1	Bromide	12/12/2018	mg/L		Source Well	CB11	0.02	0.03	2-5
Level-1	Bromide	12/12/2018	mg/L		Source Well	CB13	0.02	0.03	2-5
Level-1	Bromide	12/12/2018	mg/L		Source Well	CB15	0.02	0.03	2-7
Level-1	Bromide	12/12/2018	mg/L		Source Well	CB4	0.02	0.03	2-1
Level-1	Bromide	12/12/2018	mg/L		Source Well	CB5	0.02	0.03	2-1

Level	Analyte	Date	Final Unit	Qualifier	Type	Sample Name	MDL	Result	Group
Level-1	Bromide	12/12/2018	mg/L		Source Well	CY6	0.02	0.03	6-3
Level-1	Bromide	12/12/2018	mg/L		Source Well	MB156	0.02	0.04	8-4
Level-1	Bromide	12/12/2018	mg/L		Source Well	MB162	0.02	0.04	8-8
Level-1	Bromide	12/12/2018	mg/L		Source Well	MB155	0.02	0.06	8-2
Level-1	Fluoride	12/12/2018	mg/L		Source Well	CB17	0.01	0.06	2-3
Level-1	Bromide	12/12/2018	mg/L		Source Well	CC7	0.02	0.07	3-2
Level-1	Sulfate	12/12/2018	mg/L		Source Well	CB4	0.06	0.12	2-1
Level-1	Fluoride	12/12/2018	mg/L		Source Well	CC7	0.01	0.122	3-2
Level-1	Fluoride	12/12/2018	mg/L		Source Well	MB162	0.01	0.13	8-8
Level-1	Sulfate	12/12/2018	mg/L		Source Well	CB5	0.06	0.26	2-1
Level-1	Iron	12/12/2018	mg/L		Source Well	CB12	0.001	0.276	2-6
Level-1	Sulfate	12/12/2018	mg/L		Source Well	MB156	0.06	0.36	8-4
Level-1	Sulfate	12/12/2018	mg/L		Source Well	MB155	0.06	0.41	8-2
Level-1	Sulfate	12/12/2018	mg/L		Source Well	CY6	0.06	0.58	6-3
Level-1	Sulfate	12/12/2018	mg/L		Source Well	CB12	0.06	0.65	2-6
Level-1	Total Organic Carbon (TOC)	12/12/2018	mg/L		Source Well	CB12	0.09	0.972	2-6
Level-1	Total Organic Carbon (TOC)	12/12/2018	mg/L		Source Well	CB17	0.09	0.99	2-3
Level-1	Sulfate	12/12/2018	mg/L		Source Well	CB11	0.06	1.04	2-5
Level-1	Sulfate	12/12/2018	mg/L		Source Well	CB13	0.06	1.11	2-5
Level-1	Total Organic Carbon (TOC)	12/12/2018	mg/L		Source Well	CB16	0.09	1.2	2-4
Level-1	Total Organic Carbon (TOC)	12/12/2018	mg/L		Source Well	CY6	0.09	1.41	6-3
Level-1	Total Organic Carbon (TOC)	12/12/2018	mg/L		Source Well	CB15	0.09	1.7	2-7
Level-1	Total Organic Carbon (TOC)	12/12/2018	mg/L		Source Well	CB11	0.09	1.78	2-5
Level-1	Total Organic Carbon (TOC)	12/12/2018	mg/L		Source Well	CB13	0.09	1.78	2-5
Level-1	Chloride	12/12/2018	mg/L		Source Well	MB155	0.04	12	8-2
Level-1	Sulfate	12/12/2018	mg/L		Source Well	CC7	0.06	18.7	3-2
Level-1	TDS	12/12/2018	mg/L		Source Well	CB16	10	182	2-4
Level-1	TDS	12/12/2018	mg/L		Source Well	CB12	10	186	2-6
Level-1	TDS	12/12/2018	mg/L		Source Well	CB17	10	187	2-3
Level-1	TDS	12/12/2018	mg/L		Source Well	CB13	10	190	2-5
Level-1	TDS	12/12/2018	mg/L		Source Well	CB15	10	190	2-7
Level-1	TDS	12/12/2018	mg/L		Source Well	CB11	10	191	2-5
Level-1	Total Organic Carbon (TOC)	12/12/2018	mg/L		Source Well	CB5	0.09	2.62	2-1
Level-1	Total Organic Carbon (TOC)	12/12/2018	mg/L		Source Well	CB4	0.09	2.71	2-1
Level-1	Sulfate	12/12/2018	mg/L		Source Well	CB15	0.06	2.74	2-7
Level-1	Total Organic Carbon (TOC)	12/12/2018	mg/L		Source Well	CC7	0.09	2.77	3-2
Level-1	TDS	12/12/2018	mg/L		Source Well	CB5	10	209	2-1
Level-1	TDS	12/12/2018	mg/L		Source Well	CB4	10	216	2-1
Level-1	Temperature	12/12/2018	oC		Source Well	MB155	0.1	23.2	8-2
Level-1	Temperature	12/12/2018	oC		Source Well	CB12	0.1	23.4	2-6
Level-1	Temperature	12/12/2018	oC		Source Well	CB5	0.1	23.7	2-1
Level-1	Temperature	12/12/2018	oC		Source Well	CB11	0.1	23.8	2-5
Level-1	Temperature	12/12/2018	oC		Source Well	CB13	0.1	23.8	2-5
Level-1	Temperature	12/12/2018	oC		Source Well	CB17	0.1	23.8	2-3
Level-1	TDS	12/12/2018	mg/L		Source Well	CY6	10	231	6-3
Level-1	Temperature	12/12/2018	oC		Source Well	CB16	0.1	24.1	2-4
Level-1	Temperature	12/12/2018	oC		Source Well	CB4	0.1	24.2	2-1
Level-1	Temperature	12/12/2018	oC		Source Well	CB15	0.1	24.4	2-7
Level-1	Temperature	12/12/2018	oC		Source Well	MB156	0.1	24.4	8-4
Level-1	Temperature	12/12/2018	oC		Source Well	MB162	0.1	24.8	8-8
Level-1	Temperature	12/12/2018	oC		Source Well	CY6	0.1	24.9	6-3
Level-1	TDS	12/12/2018	mg/L		Source Well	MB156	10	277	8-4
Level-1	TDS	12/12/2018	mg/L		Source Well	MB155	10	282	8-2
Level-1	TDS	12/12/2018	mg/L		Source Well	MB162	10	296	8-8

Level	Analyte	Date	Final Unit	Qualifier	Type	Sample Name	MDL	Result	Group
Level-1	Sulfate	12/12/2018	mg/L		Source Well	CB17	0.06	3.43	2-3
Level-1	Total Organic Carbon (TOC)	12/12/2018	mg/L		Source Well	MB162	0.09	3.56	8-8
Level-1	Total Organic Carbon (TOC)	12/12/2018	mg/L		Source Well	MB156	0.09	3.61	8-4
Level-1	Conductivity	12/12/2018	umhos/cm		Source Well	CB17	1	383	2-3
Level-1	Sulfate	12/12/2018	mg/L		Source Well	MB162	0.06	4.01	8-8
Level-1	Conductivity	12/12/2018	umhos/cm		Source Well	CB16	1	401	2-4
Level-1	Conductivity	12/12/2018	umhos/cm		Source Well	CB13	1	403	2-5
Level-1	Conductivity	12/12/2018	umhos/cm		Source Well	CB12	1	408	2-6
Level-1	Conductivity	12/12/2018	umhos/cm		Source Well	CB15	1	410	2-7
Level-1	Conductivity	12/12/2018	umhos/cm		Source Well	CB11	1	413	2-5
Level-1	Conductivity	12/12/2018	umhos/cm		Source Well	CB5	1	430	2-1
Level-1	Conductivity	12/12/2018	umhos/cm		Source Well	CB4	1	449	2-1
Level-1	Conductivity	12/12/2018	umhos/cm		Source Well	CY6	1	495	6-3
Level-1	Total Organic Carbon (TOC)	12/12/2018	mg/L		Source Well	MB155	0.09	5.33	8-2
Level-1	Chloride	12/12/2018	mg/L		Source Well	CB17	0.04	5.44	2-3
Level-1	Chloride	12/12/2018	mg/L		Source Well	CB12	0.04	5.67	2-6
Level-1	Conductivity	12/12/2018	umhos/cm		Source Well	CC7	1	531	3-2
Level-1	Conductivity	12/12/2018	umhos/cm		Source Well	MB155	1	563	8-2
Level-1	Conductivity	12/12/2018	umhos/cm		Source Well	MB156	1	591	8-4
Level-1	Chloride	12/12/2018	mg/L		Source Well	CB16	0.04	6.2	2-4
Level-1	Chloride	12/12/2018	mg/L		Source Well	CB13	0.04	6.23	2-5
Level-1	Chloride	12/12/2018	mg/L		Source Well	CB15	0.04	6.4	2-7
Level-1	Chloride	12/12/2018	mg/L		Source Well	CB11	0.04	6.53	2-5
Level-1	Chloride	12/12/2018	mg/L		Source Well	CB4	0.04	6.95	2-1
Level-1	Sulfate	12/12/2018	mg/L		Source Well	CB16	0.06	6.99	2-4
Level-1	Conductivity	12/12/2018	umhos/cm		Source Well	MB162	1	615	8-8
Level-1	Chloride	12/12/2018	mg/L		Source Well	CB5	0.04	7.06	2-1
Level-1	pH	12/12/2018	pH Units		Source Well	MB155	0.01	7.06	8-2
Level-1	pH	12/12/2018	pH Units		Source Well	MB156	0.01	7.19	8-4
Level-1	pH	12/12/2018	pH Units		Source Well	CB4	0.01	7.23	2-1
Level-1	pH	12/12/2018	pH Units		Source Well	MB162	0.01	7.23	8-8
Level-1	pH	12/12/2018	pH Units		Source Well	CB5	0.01	7.27	2-1
Level-1	pH	12/12/2018	pH Units		Source Well	CY6	0.01	7.32	6-3
Level-1	pH	12/12/2018	pH Units		Source Well	CC7	0.01	7.33	3-2
Level-1	pH	12/12/2018	pH Units		Source Well	CB12	0.01	7.35	2-6
Level-1	pH	12/12/2018	pH Units		Source Well	CB13	0.01	7.36	2-5
Level-1	pH	12/12/2018	pH Units		Source Well	CB11	0.01	7.42	2-5
Level-1	pH	12/12/2018	pH Units		Source Well	CB16	0.01	7.44	2-4
Level-1	pH	12/12/2018	pH Units		Source Well	CB15	0.01	7.58	2-7
Level-1	pH	12/12/2018	pH Units		Source Well	CB17	0.01	7.63	2-3
Level-1	Chloride	12/12/2018	mg/L		Source Well	CC7	0.04	7.92	3-2
Level-1	Chloride	12/12/2018	mg/L		Source Well	MB156	0.04	8.9	8-4
Level-1	Chloride	12/12/2018	mg/L		Source Well	MB162	0.04	9.36	8-8
Level-1	Chloride	12/12/2018	mg/L		Source Well	CY6	0.04	9.67	6-3
Level-1	Bromide	12/11/2018	mg/L	l	Source Well	MB158	0.02	0.08	8-5
Level-1	Bromide	12/11/2018	mg/L	l	Source Well	MB167	0.02	0.08	8-11
Level-1	Fluoride	12/11/2018	mg/L	l	Source Well	MB158	0.01	0.119	8-5
Level-1	Fluoride	12/11/2018	mg/L	l	Source Well	MB167	0.01	0.133	8-11
Level-1	Total Organic Carbon (TOC)	12/11/2018	mg/L		Source Well	MB158	0.09	2.43	8-5
Level-1	Total Organic Carbon (TOC)	12/11/2018	mg/L		Source Well	MB167	0.09	2.94	8-11
Level-1	Sulfate	12/11/2018	mg/L		Source Well	MB158	0.06	3.38	8-5
Level-1	Conductivity	12/11/2018	umhos/cm		Source Well	MB158	1	590	8-5
Level-1	Conductivity	12/11/2018	umhos/cm		Source Well	MB167	1	598	8-11
Level-1	pH	12/11/2018	pH Units		Source Well	MB167	0.01	7.21	8-11
Level-1	pH	12/11/2018	pH Units		Source Well	MB158	0.01	7.24	8-5
Level-1	Chloride	12/11/2018	mg/L		Source Well	MB158	0.04	8.74	8-5
Level-1	Sulfate	12/11/2018	mg/L		Source Well	MB167	0.06	9.34	8-11

Level	Analyte	Date	Final Unit	Qualifier	Type	Sample Name	MDL	Result	Group
Level-1	Chloride	12/11/2018	mg/L		Source Well	MB167	0.04	9.47	8-11
Level-1	Fluoride	12/6/2018	mg/L	U	Source Well	CY10	0.01	0.01	6-3
Level-1	Free Chlorine Residual	12/6/2018	mg/L	U	Source Well	MB169	0.02	0.02	8-0
Level-1	Bromide	12/6/2018	mg/L	I	Source Well	CY10	0.02	0.075	6-3
Level-1	Bromide	12/6/2018	mg/L	I	Source Well	CY11	0.02	0.078	6-1
Level-1	Fluoride	12/6/2018	mg/L	I	Source Well	CY11	0.01	0.11	6-1
Level-1	Fluoride	12/6/2018	mg/L	I	Source Well	CY5	0.01	0.135	6-1
Level-1	Sulfate	12/6/2018	mg/L	I	Source Well	CY10	0.06	0.284	6-3
Level-1	Sulfate	12/6/2018	mg/L	I	Source Well	CY5	0.06	0.318	6-1
Level-1	Sulfate	12/6/2018	mg/L	I	Source Well	CY2	0.06	0.727	6-1
Level-1	Sulfate	12/6/2018	mg/L	I	Source Well	CY11	0.06	0.904	6-1
Level-1	Total Organic Carbon (TOC)	12/6/2018	mg/L		Source Well	CY10	0.09	1.75	6-3
Level-1	Total Organic Carbon (TOC)	12/6/2018	mg/L		Source Well	CY5	0.09	1.88	6-1
Level-1	Total Organic Carbon (TOC)	12/6/2018	mg/L		Source Well	CY11	0.09	1.95	6-1
Level-1	Total Organic Carbon (TOC)	12/6/2018	mg/L		Source Well	CY2	0.09	1.97	6-1
Level-1	Conductivity	12/6/2018	umhos/cm		Source Well	CY5	1	429	6-1
Level-1	Conductivity	12/6/2018	umhos/cm		Source Well	CY2	1	439	6-1
Level-1	Conductivity	12/6/2018	umhos/cm		Source Well	CY10	1	512	6-3
Level-1	Conductivity	12/6/2018	umhos/cm		Source Well	CY11	1	539	6-1
Level-1	pH	12/6/2018	pH Units		Source Well	CY11	0.01	7.2	6-1
Level-1	pH	12/6/2018	pH Units		Source Well	CY2	0.01	7.2	6-1
Level-1	Chloride	12/6/2018	mg/L		Source Well	CY5	0.04	7.22	6-1
Level-1	pH	12/6/2018	pH Units		Source Well	CY10	0.01	7.26	6-3
Level-1	pH	12/6/2018	pH Units		Source Well	CY5	0.01	7.35	6-1
Level-1	Chloride	12/6/2018	mg/L		Source Well	CY2	0.04	8.08	6-1
Level-1	Chloride	12/6/2018	mg/L		Source Well	CY11	0.04	8.58	6-1
Level-1	Chloride	12/6/2018	mg/L		Source Well	CY10	0.04	9.44	6-3
Level-1	Free Chlorine Residual	12/5/2018	mg/L	U	Source Well	MB169	0.02	0.02	8-0
Level-1	Bromide	12/5/2018	mg/L	I	Source Well	CY8	0.02	0.07	6-2
Level-1	Bromide	12/5/2018	mg/L	I	Source Well	CY9	0.02	0.07	6-1
Level-1	Fluoride	12/5/2018	mg/L	I	Source Well	CY9	0.01	0.12	6-1
Level-1	Sulfate	12/5/2018	mg/L	I	Source Well	CY9	0.06	0.36	6-1
Level-1	Sulfate	12/5/2018	mg/L		Source Well	CY8	0.06	1.03	6-2
Level-1	Total Organic Carbon (TOC)	12/5/2018	mg/L		Source Well	CY8	0.09	1.97	6-2
Level-1	Total Organic Carbon (TOC)	12/5/2018	mg/L		Source Well	CY9	0.09	2.09	6-1
Level-1	Conductivity	12/5/2018	umhos/cm		Source Well	CY8	1	432	6-2
Level-1	Conductivity	12/5/2018	umhos/cm		Source Well	CY9	1	505	6-1
Level-1	Chloride	12/5/2018	mg/L		Source Well	CY8	0.04	6.99	6-2
Level-1	pH	12/5/2018	pH Units		Source Well	CY8	0.01	7.49	6-2
Level-1	pH	12/5/2018	pH Units		Source Well	CY9	0.01	7.95	6-1
Level-1	Chloride	12/5/2018	mg/L		Source Well	CY9	0.04	9.13	6-1
Level-1	Free Chlorine Residual	12/4/2018	mg/L	U	Source Well	MB169	0.02	0.02	8-0
Level-1	Free Chlorine Residual	12/4/2018	mg/L	U	Source Well	MB169	0.02	0.02	8-0
Level-1	Free Chlorine Residual	12/3/2018	mg/L	U	Source Well	MB169	0.02	0.02	8-0
Level-1	Ortho P	12/3/2018	mg/L as P	U	Source Well	SCH2	0.02	0.02	11-2
Level-1	Ortho P	12/3/2018	mg/L as P	U	Source Well	SCH4	0.02	0.02	11-2
Level-1	Ortho P	12/3/2018	mg/L as P	U	Source Well	SCH5	0.02	0.02	11-2
Level-1	Ortho P	12/3/2018	mg/L as P	U	Source Well	SCH7	0.02	0.02	11-1
Level-1	Bromide	12/3/2018	mg/L	I	Source Well	SCH7	0.02	0.06	11-1
Level-1	Bromide	12/3/2018	mg/L	I	Source Well	SCH2	0.02	0.07	11-2
Level-1	Bromide	12/3/2018	mg/L	I	Source Well	SCH4	0.02	0.07	11-2
Level-1	Bromide	12/3/2018	mg/L	I	Source Well	SCH5	0.02	0.07	11-2
Level-1	Total Organic Carbon (TOC)	12/3/2018	mg/L		Source Well	SCH4	0.09	1.5	11-2

Level	Analyte	Date	Final Unit	Qualifier	Type	Sample Name	MDL	Result	Group
Level-1	Total Organic Carbon (TOC)	12/3/2018	mg/L		Source Well	SCH2	0.09	1.64	11-2
Level-1	Total Organic Carbon (TOC)	12/3/2018	mg/L		Source Well	SCH7	0.09	1.72	11-1
Level-1	Total Organic Carbon (TOC)	12/3/2018	mg/L		Source Well	SCH5	0.09	1.74	11-2
Level-1	TDS	12/3/2018	mg/L		Source Well	SCH7	10	256	11-1
Level-1	Temperature	12/3/2018	oC		Source Well	SCH4	0.1	26	11-2
Level-1	Temperature	12/3/2018	oC		Source Well	SCH5	0.1	26.1	11-2
Level-1	Temperature	12/3/2018	oC		Source Well	SCH2	0.1	26.5	11-2
Level-1	Temperature	12/3/2018	oC		Source Well	SCH7	0.1	26.7	11-1
Level-1	TDS	12/3/2018	mg/L		Source Well	SCH2	10	309	11-2
Level-1	TDS	12/3/2018	mg/L		Source Well	SCH5	10	323	11-2
Level-1	TDS	12/3/2018	mg/L		Source Well	SCH4	10	378	11-2
Level-1	Conductivity	12/3/2018	umhos/cm		Source Well	SCH7	1	512	11-1
Level-1	Conductivity	12/3/2018	umhos/cm		Source Well	SCH2	1	573	11-2
Level-1	Conductivity	12/3/2018	umhos/cm		Source Well	SCH5	1	602	11-2
Level-1	Conductivity	12/3/2018	umhos/cm		Source Well	SCH4	1	666	11-2
Level-1	pH	12/3/2018	pH Units		Source Well	SCH4	0.01	7.43	11-2
Level-1	pH	12/3/2018	pH Units		Source Well	SCH5	0.01	7.44	11-2
Level-1	pH	12/3/2018	pH Units		Source Well	SCH7	0.01	7.47	11-1
Level-1	pH	12/3/2018	pH Units		Source Well	SCH2	0.01	7.49	11-2
Level-1	Free Chlorine Residual	11/29/2018	mg/L	U	Source Well	MB169	0.02	0.02	8-0
Level-1	Ortho P	11/29/2018	mg/L as P	U	Source Well	SCH10	0.02	0.02	11-2
Level-1	Ortho P	11/29/2018	mg/L as P	U	Source Well	SCH13	0.02	0.02	11-7
Level-1	Ortho P	11/29/2018	mg/L as P	U	Source Well	SCH15	0.02	0.02	11-7
Level-1	Bromide	11/29/2018	mg/L	l	Source Well	SCH13	0.02	0.08	11-7
Level-1	Bromide	11/29/2018	mg/L	l	Source Well	SCH15	0.02	0.08	11-7
Level-1	Bromide	11/29/2018	mg/L	l	Source Well	SCH10	0.02	0.099	11-2
Level-1	TOTAL COLIFORM MF	11/29/2018	P or A/100mL	U	Source Well	MB158	1	1	8-5
Level-1	TOTAL COLIFORM MF	11/29/2018	P or A/100mL	U	Source Well	MB167	1	1	8-11
Level-1	Total Organic Carbon (TOC)	11/29/2018	mg/L		Source Well	SCH15	0.09	1.55	11-7
Level-1	Total Organic Carbon (TOC)	11/29/2018	mg/L		Source Well	SCH13	0.09	1.63	11-7
Level-1	Total Organic Carbon (TOC)	11/29/2018	mg/L		Source Well	SCH10	0.09	1.76	11-2
Level-1	TDS	11/29/2018	mg/L		Source Well	SCH10	10	224	11-2
Level-1	TDS	11/29/2018	mg/L		Source Well	SCH15	10	228	11-7
Level-1	TDS	11/29/2018	mg/L		Source Well	SCH13	10	249	11-7
Level-1	Temperature	11/29/2018	oC		Source Well	SCH10	0.1	25.6	11-2
Level-1	Temperature	11/29/2018	oC		Source Well	SCH13	0.1	26.3	11-7
Level-1	Temperature	11/29/2018	oC		Source Well	SCH15	0.1	26.6	11-7
Level-1	Conductivity	11/29/2018	umhos/cm		Source Well	SCH10	1	442	11-2
Level-1	Conductivity	11/29/2018	umhos/cm		Source Well	SCH15	1	454	11-7
Level-1	Conductivity	11/29/2018	umhos/cm		Source Well	SCH13	1	479	11-7
Level-1	pH	11/29/2018	pH Units		Source Well	SCH10	0.01	7.49	11-2
Level-1	pH	11/29/2018	pH Units		Source Well	SCH13	0.01	7.53	11-7
Level-1	pH	11/29/2018	pH Units		Source Well	SCH15	0.01	7.54	11-7
Level-1	Bromate	11/28/2018	mg/L	U	Source Well	ST10	0.00039	2.82	13-4
Level-1	Bromate	11/28/2018	mg/L	U	Source Well	ST4	0.00039	2.51	13-4
Level-1	Chlorate	11/28/2018	mg/L	U	Source Well	ST7	0.0004	3.11	13-4
Level-1	Chlorate	11/28/2018	mg/L	U	Source Well	ST8	0.0004	2.38	13-4
Level-1	Chlorite	11/28/2018	mg/L	U	Source Well	ST9	0.00047	3.77	13-5
Level-1	Chlorite	11/28/2018	mg/L	U	Source Well	ST10	0.00047	0.00047	13-4
Level-1	Nitrate	11/28/2018	mg/L as N	U	Source Well	ELW106	0.01	0.01	7-1
Level-1	Nitrate	11/28/2018	mg/L as N	U	Source Well	ELW107	0.01	0.01	7-1
Level-1	Nitrate	11/28/2018	mg/L as N	U	Source Well	ELW136	0.01	0.01	7-12
Level-1	Nitrite	11/28/2018	mg/L as N	U	Source Well	ELW106	0.01	0.01	7-1
Level-1	Nitrite	11/28/2018	mg/L as N	U	Source Well	ELW107	0.01	0.01	7-1

Level	Analyte	Date	Final Unit	Qualifier	Type	Sample Name	MDL	Result	Group
Level-1	Nitrite	11/28/2018	mg/L as N	U	Source Well	ELW136	0.01	0.01	7-12
Level-1	Free Chlorine Residual	11/28/2018	mg/L	U	Source Well	MB158	0.02	0.02	8-5
Level-1	Free Chlorine Residual	11/28/2018	mg/L	U	Source Well	MB167	0.02	0.02	8-11
Level-1	Free Chlorine Residual	11/28/2018	mg/L	U	Source Well	MB169	0.02	0.02	8-0
Level-1	Bromide	11/28/2018	mg/L		Source Well	ST10	0.00043	0.0374	13-4
Level-1	Bromide	11/28/2018	mg/L		Source Well	ELW107	0.00043	0.0387	7-1
Level-1	Bromide	11/28/2018	mg/L		Source Well	ELW105	0.00043	0.0411	7-1
Level-1	Bromide	11/28/2018	mg/L		Source Well	ELW103	0.00043	0.0431	7-1
Level-1	Bromide	11/28/2018	mg/L		Source Well	ELW101	0.00043	0.0432	7-1
Level-1	Bromide	11/28/2018	mg/L		Source Well	ELW131	0.00043	0.0435	7-9
Level-1	Bromide	11/28/2018	mg/L		Source Well	ELW106	0.00043	0.0438	7-1
Level-1	Bromide	11/28/2018	mg/L		Source Well	ELW136	0.00043	0.0498	7-12
Level-1	Fluoride	11/28/2018	mg/L	l	Source Well	MB159	0.01	0.11	8-6
Level-1	Fluoride	11/28/2018	mg/L	l	Source Well	MB160	0.01	0.11	8-6
Level-1	Fluoride	11/28/2018	mg/L	l	Source Well	MB166	0.01	0.12	8-10
Level-1	Sulfate	11/28/2018	mg/L	l	Source Well	MB159	0.06	0.21	8-6
Level-1	Sulfate	11/28/2018	mg/L	l	Source Well	MB151	0.06	0.22	8-3
Level-1	Sulfate	11/28/2018	mg/L	l	Source Well	MB160	0.06	0.48	8-6
Level-1	Sulfate	11/28/2018	mg/L		Source Well	MB150	0.06	1.04	8-3
Level-1	Sulfate	11/28/2018	mg/L		Source Well	MB157	0.06	1.62	8-2
Level-1	Chloride	11/28/2018	mg/L		Source Well	MB151	0.04	10.4	8-3
Level-1	Chloride	11/28/2018	mg/L		Source Well	MB150	0.04	10.9	8-3
Level-1	Sulfate	11/28/2018	mg/L		Source Well	MB165	0.06	11.8	8-9
Level-1	Sulfate	11/28/2018	mg/L		Source Well	MB164	0.06	15.7	8-9
Level-1	Temperature	11/28/2018	oC		Source Well	ELW101	0.1	23.8	7-1
Level-1	TDS	11/28/2018	mg/L		Source Well	ELW103	10	236	7-1
Level-1	Temperature	11/28/2018	oC		Source Well	ELW106	0.1	24	7-1
Level-1	Temperature	11/28/2018	oC		Source Well	ELW103	0.1	24.1	7-1
Level-1	Temperature	11/28/2018	oC		Source Well	ELW107	0.1	24.2	7-1
Level-1	Temperature	11/28/2018	oC		Source Well	ELW131	0.1	24.3	7-9
Level-1	Temperature	11/28/2018	oC		Source Well	ELW136	0.1	24.7	7-12
Level-1	Temperature	11/28/2018	oC		Source Well	ELW105	0.1	24.8	7-1
Level-1	Temperature	11/28/2018	oC		Source Well	ST10	0.1	25.7	13-4
Level-1	TDS	11/28/2018	mg/L		Source Well	ELW107	10	251	7-1
Level-1	TDS	11/28/2018	mg/L		Source Well	ELW131	10	252	7-9
Level-1	TDS	11/28/2018	mg/L		Source Well	ELW106	10	255	7-1
Level-1	TDS	11/28/2018	mg/L		Source Well	ELW101	10	258	7-1
Level-1	TDS	11/28/2018	mg/L		Source Well	ELW136	10	260	7-12
Level-1	TDS	11/28/2018	mg/L		Source Well	ST10	10	269	13-4
Level-1	Total Organic Carbon (TOC)	11/28/2018	mg/L		Source Well	MB166	0.09	3.04	8-10
Level-1	Total Organic Carbon (TOC)	11/28/2018	mg/L		Source Well	MB164	0.09	3.13	8-9
Level-1	Total Organic Carbon (TOC)	11/28/2018	mg/L		Source Well	MB163	0.09	3.2	8-8
Level-1	Total Organic Carbon (TOC)	11/28/2018	mg/L		Source Well	MB165	0.09	3.21	8-9
Level-1	Total Organic Carbon (TOC)	11/28/2018	mg/L		Source Well	MB151	0.09	3.58	8-3
Level-1	Total Organic Carbon (TOC)	11/28/2018	mg/L		Source Well	ELW105	0.09	3.88	7-1
Level-1	Total Organic Carbon (TOC)	11/28/2018	mg/L		Source Well	MB157	0.09	3.95	8-2
Level-1	Total Organic Carbon (TOC)	11/28/2018	mg/L		Source Well	ELW131	0.09	3.97	7-9
Level-1	Total Organic Carbon (TOC)	11/28/2018	mg/L		Source Well	ELW101	0.09	3.99	7-1
Level-1	TDS	11/28/2018	mg/L		Source Well	ELW105	10	306	7-1
Level-1	Sulfate	11/28/2018	mg/L		Source Well	MB163	0.06	34.2	8-8
Level-1	Total Organic Carbon (TOC)	11/28/2018	mg/L		Source Well	ELW107	0.09	4.02	7-1

Level	Analyte	Date	Final Unit	Qualifier	Type	Sample Name	MDL	Result	Group
Level-1	Total Organic Carbon (TOC)	11/28/2018	mg/L		Source Well	ELW103	0.09	4.17	7-1
Level-1	Total Organic Carbon (TOC)	11/28/2018	mg/L		Source Well	ELW106	0.09	4.22	7-1
Level-1	Total Organic Carbon (TOC)	11/28/2018	mg/L		Source Well	MB159	0.09	4.25	8-6
Level-1	Total Organic Carbon (TOC)	11/28/2018	mg/L		Source Well	MB160	0.09	4.4	8-6
Level-1	Total Organic Carbon (TOC)	11/28/2018	mg/L		Source Well	MB150	0.09	4.59	8-3
Level-1	Total Organic Carbon (TOC)	11/28/2018	mg/L		Source Well	ST10	0.09	4.65	13-4
Level-1	Total Organic Carbon (TOC)	11/28/2018	mg/L		Source Well	ELW136	0.09	4.96	7-12
Level-1	Conductivity	11/28/2018	umhos/cm		Source Well	ELW107	1	420	7-1
Level-1	Conductivity	11/28/2018	umhos/cm		Source Well	ELW105	1	437	7-1
Level-1	Conductivity	11/28/2018	umhos/cm		Source Well	ELW101	1	445	7-1
Level-1	Conductivity	11/28/2018	umhos/cm		Source Well	ELW131	1	445	7-9
Level-1	Conductivity	11/28/2018	umhos/cm		Source Well	ELW103	1	448	7-1
Level-1	Conductivity	11/28/2018	umhos/cm		Source Well	ELW106	1	449	7-1
Level-1	Conductivity	11/28/2018	umhos/cm		Source Well	ELW136	1	454	7-12
Level-1	Conductivity	11/28/2018	umhos/cm		Source Well	ST10	1	480	13-4
Level-1	Conductivity	11/28/2018	umhos/cm		Source Well	MB157	1	572	8-2
Level-1	Conductivity	11/28/2018	umhos/cm		Source Well	MB151	1	576	8-3
Level-1	Conductivity	11/28/2018	umhos/cm		Source Well	MB150	1	585	8-3
Level-1	Conductivity	11/28/2018	umhos/cm		Source Well	MB159	1	589	8-6
Level-1	Conductivity	11/28/2018	umhos/cm		Source Well	MB166	1	590	8-10
Level-1	Conductivity	11/28/2018	umhos/cm		Source Well	MB160	1	592	8-6
Level-1	Conductivity	11/28/2018	umhos/cm		Source Well	MB164	1	595	8-9
Level-1	Conductivity	11/28/2018	umhos/cm		Source Well	MB165	1	602	8-9
Level-1	Conductivity	11/28/2018	umhos/cm		Source Well	MB163	1	642	8-8
Level-1	pH	11/28/2018	pH Units		Source Well	MB160	0.01	7.1	8-6
Level-1	pH	11/28/2018	pH Units		Source Well	MB150	0.01	7.13	8-3
Level-1	pH	11/28/2018	pH Units		Source Well	MB157	0.01	7.17	8-2
Level-1	pH	11/28/2018	pH Units		Source Well	MB159	0.01	7.18	8-6
Level-1	pH	11/28/2018	pH Units		Source Well	MB151	0.01	7.2	8-3
Level-1	pH	11/28/2018	pH Units		Source Well	MB164	0.01	7.22	8-9
Level-1	pH	11/28/2018	pH Units		Source Well	MB163	0.01	7.23	8-8
Level-1	pH	11/28/2018	pH Units		Source Well	MB165	0.01	7.23	8-9
Level-1	pH	11/28/2018	pH Units		Source Well	MB166	0.01	7.25	8-10
Level-1	pH	11/28/2018	pH Units		Source Well	ELW101	0.01	7.3	7-1
Level-1	pH	11/28/2018	pH Units		Source Well	ELW136	0.01	7.31	7-12
Level-1	pH	11/28/2018	pH Units		Source Well	ELW106	0.01	7.35	7-1
Level-1	pH	11/28/2018	pH Units		Source Well	ELW131	0.01	7.36	7-9
Level-1	pH	11/28/2018	pH Units		Source Well	ST10	0.01	7.37	13-4
Level-1	pH	11/28/2018	pH Units		Source Well	ELW103	0.01	7.38	7-1
Level-1	pH	11/28/2018	pH Units		Source Well	ELW107	0.01	7.38	7-1
Level-1	pH	11/28/2018	pH Units		Source Well	ELW105	0.01	7.41	7-1
Level-1	Chloride	11/28/2018	mg/L		Source Well	MB165	0.04	8.32	8-9
Level-1	Chloride	11/28/2018	mg/L		Source Well	MB166	0.04	8.65	8-10
Level-1	Sulfate	11/28/2018	mg/L		Source Well	MB166	0.06	9.08	8-10
Level-1	Chloride	11/28/2018	mg/L		Source Well	MB164	0.04	9.17	8-9
Level-1	Chloride	11/28/2018	mg/L		Source Well	MB163	0.04	9.35	8-8
Level-1	Chloride	11/28/2018	mg/L		Source Well	MB157	0.04	9.56	8-2
Level-1	Chloride	11/28/2018	mg/L		Source Well	MB159	0.04	9.71	8-6
Level-1	Chloride	11/28/2018	mg/L		Source Well	MB160	0.04	9.76	8-6
Level-1	Nitrate	11/27/2018	mg/L as N	U	Source Well	BUD-2	0.01	0.01	1-1
Level-1	Nitrite	11/27/2018	mg/L as N	U	Source Well	BUD-2	0.01	0.01	1-1
Level-1	Nitrite	11/27/2018	mg/L as N	U	Source Well	BUD-4	0.01	0.01	1-2
Level-1	Nitrite	11/27/2018	mg/L as N	U	Source Well	BUD-6	0.01	0.01	1-2
Level-1	Nitrite	11/27/2018	mg/L as N	U	Source Well	BUD-7	0.01	0.01	1-4
Level-1	Bromide	11/27/2018	mg/L	U	Source Well	BUD-4	0.02	0.02	1-2

Level	Analyte	Date	Final Unit	Qualifier	Type	Sample Name	MDL	Result	Group
Level-1	Free Chlorine Residual	11/27/2018	mg/L	U	Source Well	MB158	0.02	0.02	8-5
Level-1	Free Chlorine Residual	11/27/2018	mg/L	U	Source Well	MB167	0.02	0.02	8-11
Level-1	Free Chlorine Residual	11/27/2018	mg/L	U	Source Well	MB169	0.02	0.02	8-0
Level-1	Ortho P	11/27/2018	mg/L as P	U	Source Well	BUD-2	0.02	0.02	1-1
Level-1	Ortho P	11/27/2018	mg/L as P	U	Source Well	BUD-4	0.02	0.02	1-2
Level-1	Ortho P	11/27/2018	mg/L as P	U	Source Well	BUD-6	0.02	0.02	1-2
Level-1	Ortho P	11/27/2018	mg/L as P	U	Source Well	BUD-7	0.02	0.02	1-4
Level-1	Bromide	11/27/2018	mg/L		Source Well	CO-3A	0.00043	0.0312	4-3
Level-1	Bromide	11/27/2018	mg/L		Source Well	CO-21	0.00043	0.0386	4-2
Level-1	Bromide	11/27/2018	mg/L		Source Well	CO-34	0.00043	0.0392	4-1
Level-1	Bromide	11/27/2018	mg/L		Source Well	CO-18	0.00043	0.0395	4-1
Level-1	Bromide	11/27/2018	mg/L		Source Well	CO-5	0.00043	0.0397	4-3
Level-1	Bromide	11/27/2018	mg/L		Source Well	BUD-2	0.00043	0.0409	1-1
Level-1	Bromide	11/27/2018	mg/L		Source Well	CO-7A	0.00043	0.0418	4-1
Level-1	Bromide	11/27/2018	mg/L		Source Well	CO-16	0.00043	0.0451	4-2
Level-1	Bromide	11/27/2018	mg/L		Source Well	CO-1	0.00043	0.0471	4-1
Level-1	Bromide	11/27/2018	mg/L		Source Well	CO-8	0.00043	0.048	4-1
Level-1	Bromide	11/27/2018	mg/L		Source Well	BUD-6	0.00043	0.0662	1-2
Level-1	Bromide	11/27/2018	mg/L		Source Well	BUD-7	0.00043	0.0919	1-4
Level-1	Fluoride	11/27/2018	mg/L	I	Source Well	BUD-7	0.01	0.145	1-4
Level-1	Fluoride	11/27/2018	mg/L	I	Source Well	BUD-6	0.01	0.172	1-2
Level-1	Fluoride	11/27/2018	mg/L	I	Source Well	BUD-4	0.01	0.176	1-2
Level-1	Fluoride	11/27/2018	mg/L	I	Source Well	BUD-2	0.01	0.211	1-1
Level-1	Total Organic Carbon (TOC)	11/27/2018	mg/L		Source Well	BUD-6	0.09	0.549	1-2
Level-1	Total Organic Carbon (TOC)	11/27/2018	mg/L		Source Well	BUD-7	0.09	0.596	1-4
Level-1	Total Organic Carbon (TOC)	11/27/2018	mg/L		Source Well	BUD-4	0.09	0.694	1-2
Level-1	Nitrate	11/27/2018	mg/L as N		Source Well	BUD-6	0.01	1.48	1-2
Level-1	Chloride	11/27/2018	mg/L		Source Well	BUD-2	0.04	11.3	1-1
Level-1	Sulfate	11/27/2018	mg/L		Source Well	BUD-2	0.24	125	1-1
Level-1	TDS	11/27/2018	mg/L		Source Well	CO-21	10	189	4-2
Level-1	Nitrate	11/27/2018	mg/L as N		Source Well	BUD-4	0.01	2.33	1-2
Level-1	Total Organic Carbon (TOC)	11/27/2018	mg/L		Source Well	BUD-2	0.09	2.42	1-1
Level-1	Chloride	11/27/2018	mg/L		Source Well	BUD-6	0.04	20.5	1-2
Level-1	Chloride	11/27/2018	mg/L		Source Well	BUD-4	0.04	22.3	1-2
Level-1	TDS	11/27/2018	mg/L		Source Well	CO-3A	10	223	4-3
Level-1	TDS	11/27/2018	mg/L		Source Well	CO-5	10	232	4-3
Level-1	TDS	11/27/2018	mg/L		Source Well	CO-7A	10	237	4-1
Level-1	TDS	11/27/2018	mg/L		Source Well	CO-1	10	239	4-1
Level-1	Temperature	11/27/2018	oC		Source Well	BUD-2	0.1	24	1-1
Level-1	Temperature	11/27/2018	oC		Source Well	CO-21	0.1	24.2	4-2
Level-1	Temperature	11/27/2018	oC		Source Well	BUD-6	0.1	24.3	1-2
Level-1	Temperature	11/27/2018	oC		Source Well	CO-16	0.1	24.4	4-2
Level-1	Temperature	11/27/2018	oC		Source Well	BUD-4	0.1	24.6	1-2
Level-1	Temperature	11/27/2018	oC		Source Well	BUD-7	0.1	24.7	1-4
Level-1	Temperature	11/27/2018	oC		Source Well	CO-8	0.1	24.8	4-1
Level-1	TDS	11/27/2018	mg/L		Source Well	CO-16	10	240	4-2
Level-1	TDS	11/27/2018	mg/L		Source Well	CO-8	10	240	4-1
Level-1	TDS	11/27/2018	mg/L		Source Well	CO-18	10	245	4-1
Level-1	Temperature	11/27/2018	oC		Source Well	CO-1	0.1	25	4-1
Level-1	Temperature	11/27/2018	oC		Source Well	CO-3A	0.1	25	4-3
Level-1	Temperature	11/27/2018	oC		Source Well	CO-5	0.1	25.2	4-3
Level-1	Temperature	11/27/2018	oC		Source Well	CO-18	0.1	25.5	4-1
Level-1	Temperature	11/27/2018	oC		Source Well	CO-7A	0.1	25.5	4-1
Level-1	TDS	11/27/2018	mg/L		Source Well	BUD-7	10	252	1-4
Level-1	Temperature	11/27/2018	oC		Source Well	CO-34	0.1	26	4-1
Level-1	Chloride	11/27/2018	mg/L		Source Well	BUD-7	0.04	26.6	1-4

Level	Analyte	Date	Final Unit	Qualifier	Type	Sample Name	MDL	Result	Group
Level-1	TDS	11/27/2018	mg/L		Source Well	CO-34	10	261	4-1
Level-1	TDS	11/27/2018	mg/L		Source Well	BUD-6	10	272	1-2
Level-1	TDS	11/27/2018	mg/L		Source Well	BUD-4	10	286	1-2
Level-1	Nitrate	11/27/2018	mg/L as N		Source Well	BUD-7	0.01	3.08	1-4
Level-1	Total Organic Carbon (TOC)	11/27/2018	mg/L		Source Well	CO-21	0.09	3.64	4-2
Level-1	Total Organic Carbon (TOC)	11/27/2018	mg/L		Source Well	CO-3A	0.09	3.87	4-3
Level-1	Total Organic Carbon (TOC)	11/27/2018	mg/L		Source Well	CO-16	0.09	3.88	4-2
Level-1	Total Organic Carbon (TOC)	11/27/2018	mg/L		Source Well	CO-1	0.09	3.99	4-1
Level-1	Sulfate	11/27/2018	mg/L		Source Well	BUD-7	0.06	31.4	1-4
Level-1	Conductivity	11/27/2018	umhos/cm		Source Well	CO-21	1	349	4-2
Level-1	TDS	11/27/2018	mg/L		Source Well	BUD-2	10	383	1-1
Level-1	Conductivity	11/27/2018	umhos/cm		Source Well	CO-3A	1	391	4-3
Level-1	Conductivity	11/27/2018	umhos/cm		Source Well	CO-5	1	392	4-3
Level-1	Total Organic Carbon (TOC)	11/27/2018	mg/L		Source Well	CO-5	0.09	4.03	4-3
Level-1	Total Organic Carbon (TOC)	11/27/2018	mg/L		Source Well	CO-18	0.09	4.08	4-1
Level-1	Total Organic Carbon (TOC)	11/27/2018	mg/L		Source Well	CO-7A	0.09	4.49	4-1
Level-1	Total Organic Carbon (TOC)	11/27/2018	mg/L		Source Well	CO-8	0.09	4.56	4-1
Level-1	Total Organic Carbon (TOC)	11/27/2018	mg/L		Source Well	CO-34	0.09	4.61	4-1
Level-1	Conductivity	11/27/2018	umhos/cm		Source Well	CO-1	1	410	4-1
Level-1	Conductivity	11/27/2018	umhos/cm		Source Well	CO-8	1	415	4-1
Level-1	Conductivity	11/27/2018	umhos/cm		Source Well	CO-7A	1	424	4-1
Level-1	Conductivity	11/27/2018	umhos/cm		Source Well	CO-16	1	431	4-2
Level-1	Conductivity	11/27/2018	umhos/cm		Source Well	CO-18	1	432	4-1
Level-1	Conductivity	11/27/2018	umhos/cm		Source Well	CO-34	1	435	4-1
Level-1	Conductivity	11/27/2018	umhos/cm		Source Well	BUD-7	1	475	1-4
Level-1	Conductivity	11/27/2018	umhos/cm		Source Well	BUD-6	1	515	1-2
Level-1	Sulfate	11/27/2018	mg/L		Source Well	BUD-6	0.06	54.4	1-2
Level-1	Conductivity	11/27/2018	umhos/cm		Source Well	BUD-4	1	540	1-2
Level-1	Sulfate	11/27/2018	mg/L		Source Well	BUD-4	0.06	59.8	1-2
Level-1	Conductivity	11/27/2018	umhos/cm		Source Well	BUD-2	1	675	1-1
Level-1	pH	11/27/2018	pH Units		Source Well	CO-16	0.01	7.25	4-2
Level-1	pH	11/27/2018	pH Units		Source Well	CO-1	0.01	7.26	4-1
Level-1	pH	11/27/2018	pH Units		Source Well	CO-18	0.01	7.31	4-1
Level-1	pH	11/27/2018	pH Units		Source Well	CO-21	0.01	7.31	4-2
Level-1	pH	11/27/2018	pH Units		Source Well	CO-7A	0.01	7.31	4-1
Level-1	pH	11/27/2018	pH Units		Source Well	CO-8	0.01	7.31	4-1
Level-1	pH	11/27/2018	pH Units		Source Well	CO-5	0.01	7.35	4-3
Level-1	pH	11/27/2018	pH Units		Source Well	CO-34	0.01	7.37	4-1
Level-1	pH	11/27/2018	pH Units		Source Well	CO-3A	0.01	7.38	4-3
Level-1	pH	11/27/2018	pH Units		Source Well	BUD-4	0.01	7.4	1-2
Level-1	pH	11/27/2018	pH Units		Source Well	BUD-6	0.01	7.42	1-2
Level-1	pH	11/27/2018	pH Units		Source Well	BUD-7	0.01	7.42	1-4
Level-1	pH	11/27/2018	pH Units		Source Well	BUD-2	0.01	7.43	1-1
Level-1	Temperature	1/8/2019	oC		Source Well	CO-25	0.1	23.7	4-5
Level-1	Temperature	1/8/2019	oC		Source Well	ELW116	0.1	24.5	7-7
Level-1	Conductivity	1/8/2019	umhos/cm		Source Well	ELW116	1	418	7-7
Level-1	Conductivity	1/8/2019	umhos/cm		Source Well	CO-25	1	449	4-5
Level-1	pH	1/8/2019	pH Units		Source Well	CO-25	0.01	7.01	4-5
Level-1	pH	1/8/2019	pH Units		Source Well	ELW116	0.01	7.23	7-7
Level-1	Nitrate	1/4/2019	mg/L as N	UQ	Source Well	ELW13	0.01	0.01	7-5
Level-1	Nitrate	1/4/2019	mg/L as N	UQ	Source Well	ELW9	0.01	0.01	7-2
Level-1	Nitrite	1/4/2019	mg/L as N	UQ	Source Well	ELW13	0.01	0.01	7-5
Level-1	Nitrite	1/4/2019	mg/L as N	UQ	Source Well	ELW9	0.01	0.01	7-2
Level-1	Bromide	1/4/2019	mg/L	I	Source Well	ELW13	0.02	0.084	7-5

Level	Analyte	Date	Final Unit	Qualifier	Type	Sample Name	MDL	Result	Group
Level-1	Bromide	1/4/2019	mg/L	I	Source Well	ELW10A	0.02	0.086	7-4
Level-1	Bromide	1/4/2019	mg/L	I	Source Well	ELW9	0.02	0.086	7-2
Level-1	Bromide	1/4/2019	mg/L	I	Source Well	ST9	0.02	0.09	13-5
Level-1	Bromide	1/4/2019	mg/L	I	Source Well	NWH1	0.02	0.091	9-1
Level-1	Ortho P	1/4/2019	mg/L as P	Q, I	Source Well	ELW9	0.02	0.113	7-2
Level-1	Fluoride	1/4/2019	mg/L	I	Source Well	ELW9	0.01	0.127	7-2
Level-1	Fluoride	1/4/2019	mg/L	I	Source Well	ELW13	0.01	0.13	7-5
Level-1	Fluoride	1/4/2019	mg/L	I	Source Well	NWH1	0.01	0.13	9-1
Level-1	Fluoride	1/4/2019	mg/L	I	Source Well	ELW10A	0.01	0.133	7-4
Level-1	Fluoride	1/4/2019	mg/L	I	Source Well	ST9	0.01	0.173	13-5
Level-1	Sulfate	1/4/2019	mg/L		Source Well	NWH1	0.06	1.27	9-1
Level-1	Chloride	1/4/2019	mg/L		Source Well	NWH1	0.04	11.5	9-1
Level-1	Sulfate	1/4/2019	mg/L		Source Well	ST9	0.06	19	13-5
Level-1	Temperature	1/4/2019	oC		Source Well	ELW102	0.1	23.9	7-3
Level-1	Temperature	1/4/2019	oC		Source Well	NWH1	0.1	24.4	9-1
Level-1	Temperature	1/4/2019	oC		Source Well	ELW10A	0.1	24.9	7-4
Level-1	Temperature	1/4/2019	oC		Source Well	ELW13	0.1	24.9	7-5
Level-1	Temperature	1/4/2019	oC		Source Well	ST7	0.1	24.9	13-4
Level-1	Temperature	1/4/2019	oC		Source Well	ST9	0.1	25	13-5
Level-1	Temperature	1/4/2019	oC		Source Well	ELW9	0.1	25.4	7-2
Level-1	Sulfate	1/4/2019	mg/L		Source Well	ELW9	0.06	3.31	7-2
Level-1	Total Organic Carbon (TOC)	1/4/2019	mg/L		Source Well	ELW10A	0.09	3.55	7-4
Level-1	Conductivity	1/4/2019	umhos/cm		Source Well	ELW9	1	385	7-2
Level-1	Conductivity	1/4/2019	umhos/cm		Source Well	NWH1	1	385	9-1
Level-1	Conductivity	1/4/2019	umhos/cm		Source Well	ELW10A	1	388	7-4
Level-1	Total Organic Carbon (TOC)	1/4/2019	mg/L		Source Well	ELW13	0.09	4.04	7-5
Level-1	Sulfate	1/4/2019	mg/L		Source Well	ELW13	0.06	4.13	7-5
Level-1	Total Organic Carbon (TOC)	1/4/2019	mg/L		Source Well	ST7	0.09	4.29	13-4
Level-1	Total Organic Carbon (TOC)	1/4/2019	mg/L		Source Well	ELW102	0.09	4.75	7-3
Level-1	Conductivity	1/4/2019	umhos/cm		Source Well	ELW13	1	401	7-5
Level-1	Conductivity	1/4/2019	umhos/cm		Source Well	ELW102	1	409	7-3
Level-1	Sulfate	1/4/2019	mg/L		Source Well	ELW10A	0.06	5.14	7-4
Level-1	Conductivity	1/4/2019	umhos/cm		Source Well	ST7	1	507	13-4
Level-1	Conductivity	1/4/2019	umhos/cm		Source Well	ST9	1	526	13-5
Level-1	pH	1/4/2019	pH Units		Source Well	ST9	0.01	7.22	13-5
Level-1	pH	1/4/2019	pH Units		Source Well	ST7	0.01	7.25	13-4
Level-1	pH	1/4/2019	pH Units		Source Well	NWH1	0.01	7.36	9-1
Level-1	pH	1/4/2019	pH Units		Source Well	ELW102	0.01	7.37	7-3
Level-1	pH	1/4/2019	pH Units		Source Well	ELW9	0.01	7.45	7-2
Level-1	pH	1/4/2019	pH Units		Source Well	ELW10A	0.01	7.46	7-4
Level-1	pH	1/4/2019	pH Units		Source Well	ELW13	0.01	7.48	7-5
Level-1	Chloride	1/4/2019	mg/L		Source Well	ELW9	0.04	8.26	7-2
Level-1	Chloride	1/4/2019	mg/L		Source Well	ELW10A	0.04	9.05	7-4
Level-1	Chloride	1/4/2019	mg/L		Source Well	ELW13	0.04	9.14	7-5
Level-1	Chloride	1/4/2019	mg/L		Source Well	ST9	0.04	9.9	13-5
Level-1	TDS	1/4/2019	mg/L		Source Well	ELW102		264	7-3
Level-1	TDS	1/4/2019	mg/L		Source Well	ELW10A		214	7-4
Level-1	TDS	1/4/2019	mg/L		Source Well	ELW13		238	7-5
Level-1	Nitrate	1/3/2019	mg/L as N	U	Source Well	ELW112	0.01	0.01	7-3
Level-1	Nitrate	1/3/2019	mg/L as N	U	Source Well	ELW114	0.01	0.01	7-6
Level-1	Nitrate	1/3/2019	mg/L as N	U	Source Well	ELW120	0.01	0.01	7-6
Level-1	Nitrate	1/3/2019	mg/L as N	U	Source Well	ELW139	0.01	0.01	7-6
Level-1	Nitrate	1/3/2019	mg/L as N	U	Source Well	ELW142	0.01	0.01	7-3
Level-1	Nitrite	1/3/2019	mg/L as N	U	Source Well	ELW112	0.01	0.01	7-3
Level-1	Nitrite	1/3/2019	mg/L as N	U	Source Well	ELW114	0.01	0.01	7-6
Level-1	Nitrite	1/3/2019	mg/L as N	U	Source Well	ELW120	0.01	0.01	7-6
Level-1	Nitrite	1/3/2019	mg/L as N	U	Source Well	ELW139	0.01	0.01	7-6

Level	Analyte	Date	Final Unit	Qualifier	Type	Sample Name	MDL	Result	Group
Level-1	Nitrite	1/3/2019	mg/L as N	U	Source Well	ELW142	0.01	0.01	7-3
Level-1	Bromide	1/3/2019	mg/L	UI	Source Well	ELW142	0.02	0.02	7-3
Level-1	Bromide	1/3/2019	mg/L	I	Source Well	ELW120	0.02	0.05	7-6
Level-1	Bromide	1/3/2019	mg/L	I	Source Well	NWH2	0.02	0.05	9-2
Level-1	Bromide	1/3/2019	mg/L	I	Source Well	CO-10	0.02	0.06	4-5
Level-1	Bromide	1/3/2019	mg/L	I	Source Well	ELW112	0.02	0.06	7-3
Level-1	Bromide	1/3/2019	mg/L	I	Source Well	ELW114	0.02	0.06	7-6
Level-1	Sulfate	1/3/2019	mg/L	U	Source Well	CO-12A	0.06	0.06	4-3
Level-1	Ortho P	1/3/2019	mg/L as P	I	Source Well	ELW114	0.02	0.08	7-6
Level-1	Bromide	1/3/2019	mg/L	I	Source Well	CO-12A	0.02	0.08	4-3
Level-1	Bromide	1/3/2019	mg/L	I	Source Well	CO-31	0.02	0.09	4-4
Level-1	Bromide	1/3/2019	mg/L	I	Source Well	CO-30	0.02	0.09	4-5
Level-1	Bromide	1/3/2019	mg/L	I	Source Well	NWH6	0.02	0.10	9-5
Level-1	Fluoride	1/3/2019	mg/L	I	Source Well	CO-10	0.01	0.11	4-5
Level-1	Fluoride	1/3/2019	mg/L	I	Source Well	ELW142	0.01	0.11	7-3
Level-1	Fluoride	1/3/2019	mg/L	I	Source Well	CO-12A	0.01	0.12	4-3
Level-1	Fluoride	1/3/2019	mg/L	I	Source Well	ELW112	0.01	0.12	7-3
Level-1	Fluoride	1/3/2019	mg/L	I	Source Well	NWH2	0.01	0.12	9-2
Level-1	Fluoride	1/3/2019	mg/L	I	Source Well	NWH6	0.01	0.13	9-5
Level-1	Fluoride	1/3/2019	mg/L	I	Source Well	ELW114	0.01	0.13	7-6
Level-1	Fluoride	1/3/2019	mg/L	I	Source Well	ELW120	0.01	0.13	7-6
Level-1	Fluoride	1/3/2019	mg/L	I	Source Well	CO-31	0.01	0.14	4-4
Level-1	Fluoride	1/3/2019	mg/L	I	Source Well	CO-30	0.01	0.16	4-5
Level-1	Sulfate	1/3/2019	mg/L	I	Source Well	ELW112	0.06	0.62	7-3
Level-1	Sulfate	1/3/2019	mg/L	I	Source Well	CO-30	0.06	0.67	4-5
Level-1	Total Sulfide	1/3/2019	mg/L		Source Well	ELW112	0.01	0.80	7-3
Level-1	Sulfate	1/3/2019	mg/L	I	Source Well	NWH2	0.06	0.83	9-2
Level-1	Sulfate	1/3/2019	mg/L		Source Well	ELW120	0.06	1.09	7-6
Level-1	Sulfate	1/3/2019	mg/L		Source Well	ELW142	0.06	1.91	7-3
Level-1	Chloride	1/3/2019	mg/L		Source Well	CO-12A	0.04	10.6	4-3
Level-1	Chloride	1/3/2019	mg/L		Source Well	CO-10	0.04	12.4	4-5
Level-1	Chloride	1/3/2019	mg/L		Source Well	ELW142	0.04	17.6	7-3
Level-1	TDS	1/3/2019	mg/L		Source Well	CO-10	10	189	4-5
Level-1	Chloride	1/3/2019	mg/L		Source Well	NWH6	0.04	19.6	9-5
Level-1	Sulfate	1/3/2019	mg/L		Source Well	NWH6	0.06	2.02	9-5
Level-1	Sulfate	1/3/2019	mg/L		Source Well	CO-10	0.06	2.43	4-5
Level-1	Total Organic Carbon (TOC)	1/3/2019	mg/L		Source Well	CO-10	0.09	2.98	4-5
Level-1	TDS	1/3/2019	mg/L		Source Well	ELW120	10	206	7-6
Level-1	TDS	1/3/2019	mg/L		Source Well	ELW112	10	210	7-3
Level-1	TDS	1/3/2019	mg/L		Source Well	ELW139	10	213	7-6
Level-1	TDS	1/3/2019	mg/L		Source Well	CO-12A	10	214	4-3
Level-1	TDS	1/3/2019	mg/L		Source Well	NWH2	10	214	9-2
Level-1	TDS	1/3/2019	mg/L		Source Well	ELW114	10	222	7-6
Level-1	Temperature	1/3/2019	oC		Source Well	ELW142	0.1	23.7	7-3
Level-1	Temperature	1/3/2019	oC		Source Well	ELW112	0.1	23.9	7-3
Level-1	TDS	1/3/2019	mg/L		Source Well	CO-30	10	239	4-5
Level-1	Temperature	1/3/2019	oC		Source Well	CO-10	0.1	24	4-5
Level-1	Temperature	1/3/2019	oC		Source Well	CO-12A	0.1	24.6	4-3
Level-1	Temperature	1/3/2019	oC		Source Well	ELW114	0.1	24.7	7-6
Level-1	Temperature	1/3/2019	oC		Source Well	ELW139	0.1	24.7	7-6
Level-1	Temperature	1/3/2019	oC		Source Well	NWH6	0.1	24.8	9-5
Level-1	TDS	1/3/2019	mg/L		Source Well	CO-31	10	246	4-4
Level-1	Temperature	1/3/2019	oC		Source Well	NWH2	0.1	25	9-2
Level-1	Temperature	1/3/2019	oC		Source Well	CO-30	0.1	25.2	4-5
Level-1	Temperature	1/3/2019	oC		Source Well	ELW120	0.1	25.2	7-6
Level-1	Temperature	1/3/2019	oC		Source Well	CO-31	0.1	25.8	4-4
Level-1	TDS	1/3/2019	mg/L		Source Well	ELW142	10	296	7-3
Level-1	Total Organic Carbon (TOC)	1/3/2019	mg/L		Source Well	NWH6	0.09	3	9-5
Level-1	Sulfate	1/3/2019	mg/L		Source Well	ELW114	0.06	3.18	7-6

Level	Analyte	Date	Final Unit	Qualifier	Type	Sample Name	MDL	Result	Group
Level-1	Total Organic Carbon (TOC)	1/3/2019	mg/L		Source Well	NWH2	0.09	3.31	9-2
Level-1	Total Organic Carbon (TOC)	1/3/2019	mg/L		Source Well	ELW120	0.09	3.77	7-6
Level-1	Total Organic Carbon (TOC)	1/3/2019	mg/L		Source Well	CO-12A	0.09	3.99	4-3
Level-1	Conductivity	1/3/2019	umhos/cm		Source Well	CO-10	1	352	4-5
Level-1	Conductivity	1/3/2019	umhos/cm		Source Well	ELW114	1	389	7-6
Level-1	Conductivity	1/3/2019	umhos/cm		Source Well	ELW120	1	389	7-6
Level-1	Conductivity	1/3/2019	umhos/cm		Source Well	NWH2	1	391	9-2
Level-1	Total Organic Carbon (TOC)	1/3/2019	mg/L		Source Well	ELW139	0.09	4.11	7-6
Level-1	Total Organic Carbon (TOC)	1/3/2019	mg/L		Source Well	CO-31	0.09	4.14	4-4
Level-1	Total Organic Carbon (TOC)	1/3/2019	mg/L		Source Well	CO-30	0.09	4.15	4-5
Level-1	Total Organic Carbon (TOC)	1/3/2019	mg/L		Source Well	ELW114	0.09	4.34	7-6
Level-1	Sulfate	1/3/2019	mg/L		Source Well	CO-31	0.06	4.82	4-4
Level-1	Total Organic Carbon (TOC)	1/3/2019	mg/L		Source Well	ELW142	0.09	4.85	7-3
Level-1	Conductivity	1/3/2019	umhos/cm		Source Well	ELW112	1	410	7-3
Level-1	Conductivity	1/3/2019	umhos/cm		Source Well	CO-12A	1	418	4-3
Level-1	Conductivity	1/3/2019	umhos/cm		Source Well	ELW139	1	427	7-6
Level-1	Conductivity	1/3/2019	umhos/cm		Source Well	CO-30	1	439	4-5
Level-1	Conductivity	1/3/2019	umhos/cm		Source Well	CO-31	1	451	4-4
Level-1	Conductivity	1/3/2019	umhos/cm		Source Well	NWH6	1	467	9-5
Level-1	Total Organic Carbon (TOC)	1/3/2019	mg/L		Source Well	ELW112	0.09	5.13	7-3
Level-1	Conductivity	1/3/2019	umhos/cm		Source Well	ELW142	1	502	7-3
Level-1	pH	1/3/2019	pH Units		Source Well	ELW142	0.01	7.12	7-3
Level-1	pH	1/3/2019	pH Units		Source Well	NWH6	0.01	7.21	9-5
Level-1	pH	1/3/2019	pH Units		Source Well	CO-30	0.01	7.23	4-5
Level-1	pH	1/3/2019	pH Units		Source Well	CO-12A	0.01	7.25	4-3
Level-1	pH	1/3/2019	pH Units		Source Well	ELW112	0.01	7.30	7-3
Level-1	pH	1/3/2019	pH Units		Source Well	CO-31	0.01	7.31	4-4
Level-1	pH	1/3/2019	pH Units		Source Well	CO-10	0.01	7.32	4-5
Level-1	pH	1/3/2019	pH Units		Source Well	NWH2	0.01	7.32	9-2
Level-1	pH	1/3/2019	pH Units		Source Well	ELW139	0.01	7.38	7-6
Level-1	pH	1/3/2019	pH Units		Source Well	ELW114	0.01	7.41	7-6
Level-1	pH	1/3/2019	pH Units		Source Well	ELW120	0.01	7.48	7-6
Level-1	Chloride	1/3/2019	mg/L		Source Well	ELW120	0.04	8.43	7-6
Level-1	Chloride	1/3/2019	mg/L		Source Well	NWH2	0.04	8.69	9-2
Level-1	Chloride	1/3/2019	mg/L		Source Well	ELW112	0.04	8.80	7-3
Level-1	Chloride	1/3/2019	mg/L		Source Well	ELW114	0.04	9.20	7-6
Level-1	Chloride	1/3/2019	mg/L		Source Well	CO-31	0.04	9.47	4-4
Level-1	Chloride	1/3/2019	mg/L		Source Well	CO-30	0.04	9.66	4-5
Level-1	Bromide	1/3/2019	mg/L	l	Source Well	ELW139		0.05	7-6
Level-1	TDS	1/3/2019	mg/L		Source Well	NWH6		280	9-5
Level-1	SintRegI	3/26/2019	au		Source Well	ST6		2460.1	13-3
Level-1	SintRegII	3/26/2019	au		Source Well	ST6		14841.4	13-3
Level-1	SintRegIII	3/26/2019	au		Source Well	ST6		17728.1	13-3
Level-1	UV254	3/26/2019	cm ⁻¹		Source Well	ST6		0.128	13-3
Level-1	SUVA	3/26/2019	(L/mg-m)		Source Well	ST6		2.81	13-3
Level-1	SintRegI	2/6/2019	au		Source Well	MB152		1784.4	8-1
Level-1	SintRegII	2/6/2019	au		Source Well	MB152		9328.8	8-1
Level-1	SintRegIII	2/6/2019	au		Source Well	MB152		11610.1	8-1
Level-1	UV254	2/6/2019	cm ⁻¹		Source Well	MB152		0.082	8-1
Level-1	SintRegI	1/24/2019	au		Source Well	S-21-#5		2133.8	10-2
Level-1	SintRegI	1/24/2019	au		Source Well	NWH7		2768.2	10-1
Level-1	SintRegII	1/24/2019	au		Source Well	S-21-#5		13382.3	10-2
Level-1	SintRegII	1/24/2019	au		Source Well	NWH7		15295.1	10-1
Level-1	SintRegIII	1/24/2019	au		Source Well	S-21-#5		16161.6	10-2

Level	Analyte	Date	Final Unit	Qualifier	Type	Sample Name	MDL	Result	Group
Level-1	SintRegIII	1/24/2019	au		Source Well	NWH7		18707.04	10-1
Level-1	UV254	1/24/2019	cm ⁻¹		Source Well	S-21-#5		0.099	10-2
Level-1	UV254	1/24/2019	cm ⁻¹		Source Well	NWH7		0.113	10-1
Level-1	TDS	1/24/2019	mg/L		Source Well	NWH7		260	10-1
Level-1	TDS	1/24/2019	mg/L		Source Well	S-21-#5		210	10-2
Level-1	Turbidity	1/24/2019	mg/L		Source Well	S-21-#5		0.12	10-2
Level-1	Total Organic Carbon (TOC)	1/24/2019	mg/L		Source Well	S-21-#5		2.8	10-2
Level-1	Total Organic Carbon (TOC)	1/24/2019	mg/L		Source Well	NWH7		3.6	10-1
Level-1	SUVA	1/24/2019	(L/mg-m)		Source Well	S-21-#5		3.550	10-2
Level-1	SUVA	1/24/2019	(L/mg-m)		Source Well	NWH7		3.140	10-1
Level-1	SUVA	1/24/2019	(L/mg-m)		Source Well	SP-43		2.893	12-1
Level-1	SUVA	1/24/2019	(L/mg-m)		Source Well	SP-46		2.863	12-1
Level-1	SUVA	1/24/2019	(L/mg-m)		Source Well	SP-49		2.936	12-3
Level-1	SUVA	1/24/2019	(L/mg-m)		Source Well	SP-50		2.817	12-1
Level-1	SUVA	1/24/2019	(L/mg-m)		Source Well	ST3		3.177	13-1
Level-1	Bromide	1/24/2019	mg/L	U	Source Well	NWH7		0.02	10-1
Level-1	Bromide	1/24/2019	mg/L	U	Source Well	S-21-#5		0.02	10-2
Level-1	Fluoride	1/24/2019	mg/L		Source Well	NWH7		0.1	10-1
Level-1	Nitrite	1/24/2019	mg/L	U	Source Well	NWH7		0.18	10-1
Level-1	Nitrate	1/24/2019	mg/L	U	Source Well	NWH7		0.18	10-1
Level-1	Ortho P	1/24/2019	mg/L		Source Well	NWH7		0.041	10-1
Level-1	Nitrite	1/24/2019	mg/L	U	Source Well	S-21-#5		0.18	10-2
Level-1	Nitrate	1/24/2019	mg/L	U	Source Well	S-21-#5		0.18	10-2
Level-1	Iron	1/24/2019	mg/L		Source Well	S-21-#5		0.074	10-2
Level-1	SintRegI	1/17/2019	au		Source Well	SP-50		2475.5	12-1
Level-1	SintRegI	1/17/2019	au		Source Well	ST3		1710.4	13-1
Level-1	SintRegII	1/17/2019	au		Source Well	SP-50		14498.1	12-1
Level-1	SintRegII	1/17/2019	au		Source Well	ST3		10324.799	13-1
Level-1	SintRegIII	1/17/2019	au		Source Well	SP-50		17863.305	12-1
Level-1	SintRegIII	1/17/2019	au		Source Well	ST3		12762.4	13-1
Level-1	UV254	1/17/2019	cm ⁻¹		Source Well	SP-50		0.126	12-1
Level-1	UV254	1/17/2019	cm ⁻¹		Source Well	ST3		0.097	13-1
Level-1	Total Organic Carbon (TOC)	1/17/2019	mg/L		Source Well	SP-50		4.47	12-1
Level-1	Bromide	1/17/2019	mg/L	U	Source Well	SP-50		0.02	12-1
Level-1	TDS	1/17/2019	mg/L		Source Well	SP-50		231	12-1
Level-1	Total Organic Carbon (TOC)	1/17/2019	mg/L		Source Well	ST3		3.05	13-1
Level-1	Bromide	1/17/2019	mg/L	U	Source Well	ST3		0.02	13-1
Level-1	TDS	1/17/2019	mg/L		Source Well	ST3		182	13-1
Level-1	Bromide	1/16/2019	mg/L	I	Source Well	SP-43		0.05	12-1
Level-1	Bromide	1/16/2019	mg/L	I	Source Well	SP-46		0.05	12-1
Level-1	Bromide	1/16/2019	mg/L	I	Source Well	SP-49		0.05	12-3
Level-1	SintRegI	1/16/2019	au		Source Well	SP-43		2736.9	12-1
Level-1	SintRegI	1/16/2019	au		Source Well	SP-46		2695.5	12-1
Level-1	SintRegI	1/16/2019	au		Source Well	SP-49		2408.8	12-3
Level-1	SintRegII	1/16/2019	au		Source Well	SP-43		14640.1	12-1
Level-1	SintRegII	1/16/2019	au		Source Well	SP-46		16342.8	12-1
Level-1	SintRegII	1/16/2019	au		Source Well	SP-49		14063.499	12-3
Level-1	SintRegIII	1/16/2019	au		Source Well	SP-43		17662.5	12-1
Level-1	SintRegIII	1/16/2019	au		Source Well	SP-46		19840.1	12-1
Level-1	SintRegIII	1/16/2019	au		Source Well	SP-49		17014.3	12-3
Level-1	UV254	1/16/2019	cm ⁻¹		Source Well	SP-43		0.119	12-1
Level-1	UV254	1/16/2019	cm ⁻¹		Source Well	SP-46		0.135	12-1
Level-1	UV254	1/16/2019	cm ⁻¹		Source Well	SP-49		0.115	12-3
Level-1	Total Organic Carbon (TOC)	1/16/2019	mg/L		Source Well	SP-43		4.1	12-1
Level-1	TDS	1/16/2019	mg/L		Source Well	SP-43		249	12-1
Level-1	Total Organic Carbon (TOC)	1/16/2019	mg/L		Source Well	SP-46		4.73	12-1

Level	Analyte	Date	Final Unit	Qualifier	Type	Sample Name	MDL	Result	Group
Level-1	TDS	1/16/2019	mg/L		Source Well	SP-46		245	12-1
Level-1	Total Organic Carbon (TOC)	1/16/2019	mg/L		Source Well	SP-49		3.93	12-3
Level-1	TDS	1/16/2019	mg/L		Source Well	SP-49		230	12-3
Level-1	SUVA	1/11/2019	(L/mg-m)		Source Well	BUD-2		2.077	1-1
Level-1	SUVA	1/11/2019	(L/mg-m)		Source Well	BUD-4		0.701	1-2
Level-1	SUVA	1/11/2019	(L/mg-m)		Source Well	BUD-5R		1.746	1-3
Level-1	SUVA	1/11/2019	(L/mg-m)		Source Well	BUD-6		1.211	1-2
Level-1	SUVA	1/11/2019	(L/mg-m)		Source Well	BUD-7		0.709	1-4
Level-1	SUVA	1/11/2019	(L/mg-m)		Source Well	CB1		2.063	2-9
Level-1	SUVA	1/11/2019	(L/mg-m)		Source Well	CB10		1.703	2-1
Level-1	SUVA	1/11/2019	(L/mg-m)		Source Well	CB11		1.4253997	2-5
Level-1	SUVA	1/11/2019	(L/mg-m)		Source Well	CB12		0.654	2-6
Level-1	SUVA	1/11/2019	(L/mg-m)		Source Well	CB13		1.375	2-5
Level-1	SUVA	1/11/2019	(L/mg-m)		Source Well	CB15		1.801	2-7
Level-1	SUVA	1/11/2019	(L/mg-m)		Source Well	CB16		1.285	2-4
Level-1	SUVA	1/11/2019	(L/mg-m)		Source Well	CB17		0.844	2-3
Level-1	SUVA	1/11/2019	(L/mg-m)		Source Well	CB2		1.865	2-8
Level-1	SUVA	1/11/2019	(L/mg-m)		Source Well	CB4		1.597	2-1
Level-1	SUVA	1/11/2019	(L/mg-m)		Source Well	CB5		1.576	2-1
Level-1	SUVA	1/11/2019	(L/mg-m)		Source Well	CB7		2.049	2-8
Level-1	SUVA	1/11/2019	(L/mg-m)		Source Well	CC1		2.433	3-1
Level-1	SUVA	1/11/2019	(L/mg-m)		Source Well	CC10		2.508	3-4
Level-1	SUVA	1/11/2019	(L/mg-m)		Source Well	CC11		3.015	3-5
Level-1	SUVA	1/11/2019	(L/mg-m)		Source Well	CC12		2.124	3-3
Level-1	SUVA	1/11/2019	(L/mg-m)		Source Well	CC2		2.392	3-2
Level-1	SUVA	1/11/2019	(L/mg-m)		Source Well	CC3		2.247	3-3
Level-1	SUVA	1/11/2019	(L/mg-m)		Source Well	CC4		1.930	3-1
Level-1	SUVA	1/11/2019	(L/mg-m)		Source Well	CC6		2.253	3-3
Level-1	SUVA	1/11/2019	(L/mg-m)		Source Well	CC9		2.233	3-2
Level-1	SUVA	1/11/2019	(L/mg-m)		Source Well	CO-1		3.091	4-1
Level-1	SUVA	1/11/2019	(L/mg-m)		Source Well	CO-10		3.288	4-5
Level-1	SUVA	1/11/2019	(L/mg-m)		Source Well	CO-12A		3.236	4-3
Level-1	SUVA	1/11/2019	(L/mg-m)		Source Well	CO-16		2.754	4-2
Level-1	SUVA	1/11/2019	(L/mg-m)		Source Well	CO-18		3.235	4-1
Level-1	SUVA	1/11/2019	(L/mg-m)		Source Well	CO-21		2.920	4-2
Level-1	SUVA	1/11/2019	(L/mg-m)		Source Well	CO-25		3.182	4-5
Level-1	SUVA	1/11/2019	(L/mg-m)		Source Well	CO-30		3.270	4-5
Level-1	SUVA	1/11/2019	(L/mg-m)		Source Well	CO-31		4.089	4-4
Level-1	SUVA	1/11/2019	(L/mg-m)		Source Well	CO-34		3.187	4-1
Level-1	SUVA	1/11/2019	(L/mg-m)		Source Well	CO-3A		3.076	4-3
Level-1	SUVA	1/11/2019	(L/mg-m)		Source Well	CO-5		3.005	4-3
Level-1	SUVA	1/11/2019	(L/mg-m)		Source Well	CO-7A		2.718	4-1
Level-1	SUVA	1/11/2019	(L/mg-m)		Source Well	CO-8		2.906	4-1
Level-1	SUVA	1/11/2019	(L/mg-m)		Source Well	CRLWD1		2.987	5-1
Level-1	SUVA	1/11/2019	(L/mg-m)		Source Well	CRLWD2		2.524	5-1
Level-1	SUVA	1/11/2019	(L/mg-m)		Source Well	CRLWD3		2.473	5-1
Level-1	SUVA	1/11/2019	(L/mg-m)		Source Well	CY11		1.595	6-1
Level-1	SUVA	1/11/2019	(L/mg-m)		Source Well	CY4		1.886	6-1
Level-1	SUVA	1/11/2019	(L/mg-m)		Source Well	CY6		1.545	6-3
Level-1	SUVA	1/11/2019	(L/mg-m)		Source Well	CY8		2.377	6-2
Level-1	SUVA	1/11/2019	(L/mg-m)		Source Well	CY9		1.955	6-1
Level-1	SUVA	1/11/2019	(L/mg-m)		Source Well	ELW101		2.515	7-1
Level-1	SUVA	1/11/2019	(L/mg-m)		Source Well	ELW102		2.588	7-3
Level-1	SUVA	1/11/2019	(L/mg-m)		Source Well	ELW103		2.465	7-1
Level-1	SUVA	1/11/2019	(L/mg-m)		Source Well	ELW105		2.537	7-1
Level-1	SUVA	1/11/2019	(L/mg-m)		Source Well	ELW106		2.544	7-1
Level-1	SUVA	1/11/2019	(L/mg-m)		Source Well	ELW107		2.549	7-1
Level-1	SUVA	1/11/2019	(L/mg-m)		Source Well	ELW10A		3.302	7-4
Level-1	SUVA	1/11/2019	(L/mg-m)		Source Well	ELW110		3.047	7-6

Level	Analyte	Date	Final Unit	Qualifier	Type	Sample Name	MDL	Result	Group
Level-1	SUVA	1/11/2019	(L/mg-m)		Source Well	ELW112		2.963	7-3
Level-1	SUVA	1/11/2019	(L/mg-m)		Source Well	ELW113		2.995	7-6
Level-1	SUVA	1/11/2019	(L/mg-m)		Source Well	ELW114		3.303	7-6
Level-1	SUVA	1/11/2019	(L/mg-m)		Source Well	ELW116		3.258	7-7
Level-1	SUVA	1/11/2019	(L/mg-m)		Source Well	ELW120		3.160	7-6
Level-1	SUVA	1/11/2019	(L/mg-m)		Source Well	ELW13		3.448	7-5
Level-1	SUVA	1/11/2019	(L/mg-m)		Source Well	ELW131		2.563	7-9
Level-1	SUVA	1/11/2019	(L/mg-m)		Source Well	ELW136		2.563	7-12
Level-1	SUVA	1/11/2019	(L/mg-m)		Source Well	ELW137		2.841	7-6
Level-1	SUVA	1/11/2019	(L/mg-m)		Source Well	ELW139		3.035	7-6
Level-1	SUVA	1/11/2019	(L/mg-m)		Source Well	ELW140		2.688	7-3
Level-1	SUVA	1/11/2019	(L/mg-m)		Source Well	ELW141		2.822	7-3
Level-1	SUVA	1/11/2019	(L/mg-m)		Source Well	ELW142		2.701	7-3
Level-1	SUVA	1/11/2019	(L/mg-m)		Source Well	ELW9		3.560	7-2
Level-1	SUVA	1/11/2019	(L/mg-m)		Source Well	MB151		1.761	8-3
Level-1	SUVA	1/11/2019	(L/mg-m)		Source Well	MB153		1.651	8-2
Level-1	SUVA	1/11/2019	(L/mg-m)		Source Well	MB154		1.725	8-2
Level-1	SUVA	1/11/2019	(L/mg-m)		Source Well	MB155		2.008	8-2
Level-1	SUVA	1/11/2019	(L/mg-m)		Source Well	MB156		1.846	8-4
Level-1	SUVA	1/11/2019	(L/mg-m)		Source Well	MB157		1.907	8-2
Level-1	SUVA	1/11/2019	(L/mg-m)		Source Well	MB158		1.516	8-5
Level-1	SUVA	1/11/2019	(L/mg-m)		Source Well	MB159		1.770	8-6
Level-1	SUVA	1/11/2019	(L/mg-m)		Source Well	MB162		1.830	8-8
Level-1	SUVA	1/11/2019	(L/mg-m)		Source Well	MB164		1.881	8-9
Level-1	SUVA	1/11/2019	(L/mg-m)		Source Well	MB166		2.458	8-10
Level-1	SUVA	1/11/2019	(L/mg-m)		Source Well	MB167		1.761	8-11
Level-1	SUVA	1/11/2019	(L/mg-m)		Source Well	MB169		1.681	8-0
Level-1	SUVA	1/11/2019	(L/mg-m)		Source Well	NWH1		3.011	9-1
Level-1	SUVA	1/11/2019	(L/mg-m)		Source Well	NWH2		2.723	9-2
Level-1	SUVA	1/11/2019	(L/mg-m)		Source Well	NWH3		2.842	9-3
Level-1	SUVA	1/11/2019	(L/mg-m)		Source Well	NWH4		2.345	9-3
Level-1	SUVA	1/11/2019	(L/mg-m)		Source Well	NWH5		3.094	9-4
Level-1	SUVA	1/11/2019	(L/mg-m)		Source Well	NWH6		2.791	9-5
Level-1	SUVA	1/11/2019	(L/mg-m)		Source Well	S-21-#10		2.871	10-1
Level-1	SUVA	1/11/2019	(L/mg-m)		Source Well	S-21-#8		3.080	10-1
Level-1	SUVA	1/11/2019	(L/mg-m)		Source Well	SCH1		2.716	11-1
Level-1	SUVA	1/11/2019	(L/mg-m)		Source Well	SCH10		2.113	11-2
Level-1	SUVA	1/11/2019	(L/mg-m)		Source Well	SCH13		2.747	11-7
Level-1	SUVA	1/11/2019	(L/mg-m)		Source Well	SCH14		3.188	11-8
Level-1	SUVA	1/11/2019	(L/mg-m)		Source Well	SCH15		2.394	11-7
Level-1	SUVA	1/11/2019	(L/mg-m)		Source Well	SCH2		1.871	11-2
Level-1	SUVA	1/11/2019	(L/mg-m)		Source Well	SCH4		2.249	11-2
Level-1	SUVA	1/11/2019	(L/mg-m)		Source Well	SCH5		2.008	11-2
Level-1	SUVA	1/11/2019	(L/mg-m)		Source Well	SCH7		2.530	11-1
Level-1	SUVA	1/11/2019	(L/mg-m)		Source Well	SCH8		2.119	11-2
Level-1	SUVA	1/11/2019	(L/mg-m)		Source Well	ST10		2.818	13-4
Level-1	SUVA	1/11/2019	(L/mg-m)		Source Well	ST4		2.509	13-4
Level-1	SUVA	1/11/2019	(L/mg-m)		Source Well	ST7		3.111	13-4
Level-1	SUVA	1/11/2019	(L/mg-m)		Source Well	ST8		2.376	13-4
Level-1	SUVA	1/11/2019	(L/mg-m)		Source Well	ST9		3.765	13-5
Level-1	SIntRegI	1/10/2019	au		Source Well	MB164		1383.2	8-9
Level-1	SIntRegI	1/10/2019	au		Source Well	MB166		1225.9	8-10
Level-1	SIntRegI	1/10/2019	au		Source Well	SCH17		1021.3	11-7
Level-1	SIntRegII	1/10/2019	au		Source Well	BUD-5R		676.5	1-3
Level-1	SIntRegII	1/10/2019	au		Source Well	MB164		6954.8	8-9
Level-1	SIntRegII	1/10/2019	au		Source Well	MB166		6668.0	8-10
Level-1	SIntRegII	1/10/2019	au		Source Well	SCH17		4967.6	11-7
Level-1	SIntRegII	1/10/2019	au		Source Well	BUD-5R		3525.2	1-3
Level-1	SIntRegIII	1/10/2019	au		Source Well	MB164		8799.9	8-9
Level-1	SIntRegIII	1/10/2019	au		Source Well	MB166		8459.1	8-10

Level	Analyte	Date	Final Unit	Qualifier	Type	Sample Name	MDL	Result	Group
Level-1	SIntRegIII	1/10/2019	au		Source Well	SCH17		6391.9	11-7
Level-1	SIntRegIII	1/10/2019	au		Source Well	BUD-5R		4456.5	1-3
Level-1	UV254	1/10/2019	cm ⁻¹		Source Well	MB164		0.059	8-9
Level-1	UV254	1/10/2019	cm ⁻¹		Source Well	MB166		0.052	8-10
Level-1	UV254	1/10/2019	cm ⁻¹		Source Well	SCH17		0.032	11-7
Level-1	UV254	1/10/2019	cm ⁻¹		Source Well	BUD-5R		0.021	1-3
Level-1	Bromide	1/10/2019	mg/L	I	Source Well	MB164		0.082	8-9
Level-1	TDS	1/10/2019	mg/L		Source Well	MB164		293	8-9
Level-1	Total Sulfide	1/10/2019	mg/L		Source Well	MB164		0.72	8-9
Level-1	Total Organic Carbon (TOC)	1/10/2019	mg/L		Source Well	SCH16		1.58	11-9
Level-1	Bromide	1/10/2019	mg/L	U	Source Well	SCH16		0.02	11-9
Level-1	Ortho P	1/10/2019	mg/L	U	Source Well	SCH16		0.02	11-9
Level-1	Total Organic Carbon (TOC)	1/10/2019	mg/L		Source Well	BUD-5R		1.22	1-3
Level-1	Bromide	1/10/2019	mg/L		Source Well	BUD-5R		0.124	1-3
Level-1	TDS	1/10/2019	mg/L		Source Well	BUD-5R		175	1-3
Level-1	Fluoride	1/10/2019	mg/L		Source Well	BUD-5R		0.234	1-3
Level-1	Nitrite	1/10/2019	mg/L	U	Source Well	BUD-5R		0.01	1-3
Level-1	Ortho P	1/10/2019	mg/L		Source Well	BUD-5R		0.118	1-3
Level-1	Total Organic Carbon (TOC)	1/10/2019	mg/L		Source Well	MB166		1.22	8-10
Level-1	Bromide	1/10/2019	mg/L	I	Source Well	MB166		0.082	8-10
Level-1	TDS	1/10/2019	mg/L		Source Well	MB166		299	8-10
Level-1	Total Organic Carbon (TOC)	1/10/2019	mg/L		Source Well	MB164		3.02	8-9
Level-1	TDS	1/10/2019	mg/L		Source Well	SCH16		307	11-9
Level-1	SIntRegI	1/8/2019	au		Source Well	ELW116		2346.9	7-7
Level-1	SIntRegI	1/8/2019	au		Source Well	CO-25		2265.7	4-5
Level-1	SIntRegII	1/8/2019	au		Source Well	ELW116		16167.5	7-7
Level-1	SIntRegII	1/8/2019	au		Source Well	CO-25		15462.2	4-5
Level-1	SIntRegIII	1/8/2019	au		Source Well	ELW116		19750.1	7-7
Level-1	SIntRegIII	1/8/2019	au		Source Well	CO-25		18489.204	4-5
Level-1	UV254	1/8/2019	cm ⁻¹		Source Well	ELW116		0.148	7-7
Level-1	UV254	1/8/2019	cm ⁻¹		Source Well	CO-25		0.129	4-5
Level-1	Total Organic Carbon (TOC)	1/8/2019	mg/L		Source Well	CO-25		4.07	4-5
Level-1	Bromide	1/8/2019	mg/L	I	Source Well	CO-25		0.096	4-5
Level-1	TDS	1/8/2019	mg/L		Source Well	CO-25		231	4-5
Level-1	Total Organic Carbon (TOC)	1/8/2019	mg/L		Source Well	ELW116		4.53	7-7
Level-1	Bromide	1/8/2019	mg/L	I	Source Well	ELW116		0.103	7-7
Level-1	TDS	1/8/2019	mg/L		Source Well	ELW116		220	7-7
Level-1	SIntRegI	1/4/2019	au		Source Well	ST9		2910.0	13-5
Level-1	SIntRegI	1/4/2019	au		Source Well	NWH1		2006.9	9-1
Level-1	SIntRegI	1/4/2019	au		Source Well	ELW9		2614.5	7-2
Level-1	SIntRegI	1/4/2019	au		Source Well	ELW10A		2266.4	7-4
Level-1	SIntRegI	1/4/2019	au		Source Well	ELW13		2635.8	7-5
Level-1	SIntRegI	1/4/2019	au		Source Well	ELW102		2533.5	7-3
Level-1	SIntRegI	1/4/2019	au		Source Well	ST7		2863.5	13-4
Level-1	SIntRegII	1/4/2019	au		Source Well	ST9		18064.6	13-5
Level-1	SIntRegII	1/4/2019	au		Source Well	NWH1		12212.8	9-1
Level-1	SIntRegII	1/4/2019	au		Source Well	ELW9		17221.4	7-2
Level-1	SIntRegII	1/4/2019	au		Source Well	ELW10A		14833.1	7-4
Level-1	SIntRegII	1/4/2019	au		Source Well	ELW13		17296.2	7-5
Level-1	SIntRegII	1/4/2019	au		Source Well	ELW102		16706.2	7-3
Level-1	SIntRegII	1/4/2019	au		Source Well	ST7		17205.3	13-4
Level-1	SIntRegIII	1/4/2019	au		Source Well	ST9		21665.6	13-5
Level-1	SIntRegIII	1/4/2019	au		Source Well	NWH1		14575.9	9-1
Level-1	SIntRegIII	1/4/2019	au		Source Well	ELW9		20671.0	7-2
Level-1	SIntRegIII	1/4/2019	au		Source Well	ELW10A		17742.9	7-4
Level-1	SIntRegIII	1/4/2019	au		Source Well	ELW13		20551.6	7-5

Level	Analyte	Date	Final Unit	Qualifier	Type	Sample Name	MDL	Result	Group
Level-1	SntRegIII	1/4/2019	au		Source Well	ELW102		20282.1	7-3
Level-1	SntRegIII	1/4/2019	au		Source Well	ST7		20709.2	13-4
Level-1	UV254	1/4/2019	cm ⁻¹		Source Well	ST9		0.173	13-5
Level-1	UV254	1/4/2019	cm ⁻¹		Source Well	NWH1		0.091	9-1
Level-1	UV254	1/4/2019	cm ⁻¹		Source Well	ELW9		0.153	7-2
Level-1	UV254	1/4/2019	cm ⁻¹		Source Well	ELW10A		0.117	7-4
Level-1	UV254	1/4/2019	cm ⁻¹		Source Well	ELW13		0.139	7-5
Level-1	UV254	1/4/2019	cm ⁻¹		Source Well	ELW102		0.141	7-3
Level-1	UV254	1/4/2019	cm ⁻¹		Source Well	ST7		0.156	13-4
Level-1	Total Organic Carbon (TOC)	1/4/2019	mg/L		Source Well	ST9		4.59	13-5
Level-1	Bromide	1/4/2019	mg/L	l	Source Well	ST9		0.09	13-5
Level-1	TDS	1/4/2019	mg/L		Source Well	ST9		301	13-5
Level-1	Total Organic Carbon (TOC)	1/4/2019	mg/L		Source Well	ELW9		4.29	7-2
Level-1	TDS	1/4/2019	mg/L		Source Well	ELW9		237	7-2
Level-1	SntRegI	1/3/2019	au		Source Well	NWH2		2080.5	9-2
Level-1	SntRegI	1/3/2019	au		Source Well	CO-10		1699.3	4-5
Level-1	SntRegI	1/3/2019	au		Source Well	CO-12A		2624.0	4-3
Level-1	SntRegI	1/3/2019	au		Source Well	CO-30		2861.8	4-5
Level-1	SntRegI	1/3/2019	au		Source Well	CO-31		3155.7	4-4
Level-1	SntRegI	1/3/2019	au		Source Well	ELW112		2800.4	7-3
Level-1	SntRegI	1/3/2019	au		Source Well	ELW114		2409.9	7-6
Level-1	SntRegI	1/3/2019	au		Source Well	ELW120		2427.0	7-6
Level-1	SntRegI	1/3/2019	au		Source Well	ELW142		2601.0	7-3
Level-1	SntRegI	1/3/2019	au		Source Well	ELW139		2513.5	7-6
Level-1	SntRegI	1/3/2019	au		Source Well	NWH6		1792.2	9-5
Level-1	SntRegII	1/3/2019	au		Source Well	NWH2		12937.6	9-2
Level-1	SntRegII	1/3/2019	au		Source Well	CO-10		12145.124	4-5
Level-1	SntRegII	1/3/2019	au		Source Well	CO-12A		16530.4	4-3
Level-1	SntRegII	1/3/2019	au		Source Well	CO-30		18381.3	4-5
Level-1	SntRegII	1/3/2019	au		Source Well	CO-31		19462.6	4-4
Level-1	SntRegII	1/3/2019	au		Source Well	ELW112		18365.3	7-3
Level-1	SntRegII	1/3/2019	au		Source Well	ELW114		16605.7	7-6
Level-1	SntRegII	1/3/2019	au		Source Well	ELW120		15889.2	7-6
Level-1	SntRegII	1/3/2019	au		Source Well	ELW142		15803.6	7-3
Level-1	SntRegII	1/3/2019	au		Source Well	ELW139		15926.4	7-6
Level-1	SntRegII	1/3/2019	au		Source Well	NWH6		10768.9	9-5
Level-1	SntRegIII	1/3/2019	au		Source Well	NWH2		15336.0	9-2
Level-1	SntRegIII	1/3/2019	au		Source Well	CO-10		14414.5	4-5
Level-1	SntRegIII	1/3/2019	au		Source Well	CO-12A		19596.6	4-3
Level-1	SntRegIII	1/3/2019	au		Source Well	CO-30		21603.2	4-5
Level-1	SntRegIII	1/3/2019	au		Source Well	CO-31		23089.8	4-4
Level-1	SntRegIII	1/3/2019	au		Source Well	ELW112		22022.5	7-3
Level-1	SntRegIII	1/3/2019	au		Source Well	ELW114		19893.7	7-6
Level-1	SntRegIII	1/3/2019	au		Source Well	ELW120		18817.9	7-6
Level-1	SntRegIII	1/3/2019	au		Source Well	ELW142		19372.6	7-3
Level-1	SntRegIII	1/3/2019	au		Source Well	ELW139		19134.8	7-6
Level-1	SntRegIII	1/3/2019	au		Source Well	NWH6		12921.9	9-5
Level-1	UV254	1/3/2019	cm ⁻¹		Source Well	NWH2		0.090	9-2
Level-1	UV254	1/3/2019	cm ⁻¹		Source Well	CO-10		0.097	4-5
Level-1	UV254	1/3/2019	cm ⁻¹		Source Well	CO-12A		0.129	4-3
Level-1	UV254	1/3/2019	cm ⁻¹		Source Well	CO-30		0.137	4-5
Level-1	UV254	1/3/2019	cm ⁻¹		Source Well	CO-31		0.170	4-4
Level-1	UV254	1/3/2019	cm ⁻¹		Source Well	ELW112		0.155	7-3
Level-1	UV254	1/3/2019	cm ⁻¹		Source Well	ELW114		0.143	7-6
Level-1	UV254	1/3/2019	cm ⁻¹		Source Well	ELW120		0.119	7-6
Level-1	UV254	1/3/2019	cm ⁻¹		Source Well	ELW142		0.131	7-3
Level-1	UV254	1/3/2019	cm ⁻¹		Source Well	ELW139		0.125	7-6
Level-1	UV254	1/3/2019	cm ⁻¹		Source Well	NWH6		0.084	9-5
Level-1	SntRegI	12/27/2018	au		Source Well	ST4		2213.1	13-4

Level	Analyte	Date	Final Unit	Qualifier	Type	Sample Name	MDL	Result	Group
Level-1	SIntRegI	12/27/2018	au		Source Well	ST8		2689.1	13-4
Level-1	SIntRegI	12/27/2018	au		Source Well	MB157		1613.4	8-2
Level-1	SIntRegI	12/27/2018	au		Source Well	MB158		958.2	8-5
Level-1	SIntRegI	12/27/2018	au		Source Well	MB167		1084.2	8-11
Level-1	SIntRegI	12/27/2018	au		Source Well	MB169		1231.0	8-0
Level-1	SIntRegI	12/27/2018	au		Source Well	MB151		1667.1	8-3
Level-1	SIntRegI	12/27/2018	au		Source Well	MB153		1771.6	8-2
Level-1	SIntRegI	12/27/2018	au		Source Well	MB154		1740.4	8-2
Level-1	SIntRegI	12/27/2018	au		Source Well	MB159		1750.7	8-6
Level-1	SIntRegII	12/27/2018	au		Source Well	ST4		13623.8	13-4
Level-1	SIntRegII	12/27/2018	au		Source Well	ST8		16512.6	13-4
Level-1	SIntRegII	12/27/2018	au		Source Well	MB157		9141.7	8-2
Level-1	SIntRegII	12/27/2018	au		Source Well	MB158		4936.0	8-5
Level-1	SIntRegII	12/27/2018	au		Source Well	MB167		6238.3	8-11
Level-1	SIntRegII	12/27/2018	au		Source Well	MB169		6886.4	8-0
Level-1	SIntRegII	12/27/2018	au		Source Well	MB151		7847.9	8-3
Level-1	SIntRegII	12/27/2018	au		Source Well	MB153		8786.9	8-2
Level-1	SIntRegII	12/27/2018	au		Source Well	MB154		9871.9	8-2
Level-1	SIntRegII	12/27/2018	au		Source Well	MB159		8729.6	8-6
Level-1	SIntRegIII	12/27/2018	au		Source Well	ST4		16511.4	13-4
Level-1	SIntRegIII	12/27/2018	au		Source Well	ST8		19707.7	13-4
Level-1	SIntRegIII	12/27/2018	au		Source Well	MB157		11679.8	8-2
Level-1	SIntRegIII	12/27/2018	au		Source Well	MB158		6394.3	8-5
Level-1	SIntRegIII	12/27/2018	au		Source Well	MB167		7984.6	8-11
Level-1	SIntRegIII	12/27/2018	au		Source Well	MB169		8821.2	8-0
Level-1	SIntRegIII	12/27/2018	au		Source Well	MB151		10061.3	8-3
Level-1	SIntRegIII	12/27/2018	au		Source Well	MB153		11291.0	8-2
Level-1	SIntRegIII	12/27/2018	au		Source Well	MB154		12606.7	8-2
Level-1	SIntRegIII	12/27/2018	au		Source Well	MB159		11225.0	8-6
Level-1	UV254	12/27/2018	cm ⁻¹		Source Well	ST4		0.120	13-4
Level-1	UV254	12/27/2018	cm ⁻¹		Source Well	ST8		0.127	13-4
Level-1	UV254	12/27/2018	cm ⁻¹		Source Well	MB157		0.083	8-2
Level-1	UV254	12/27/2018	cm ⁻¹		Source Well	MB158		0.041	8-5
Level-1	UV254	12/27/2018	cm ⁻¹		Source Well	MB167		0.055	8-11
Level-1	UV254	12/27/2018	cm ⁻¹		Source Well	MB169		0.063	8-0
Level-1	UV254	12/27/2018	cm ⁻¹		Source Well	MB151		0.068	8-3
Level-1	UV254	12/27/2018	cm ⁻¹		Source Well	MB153		0.076	8-2
Level-1	UV254	12/27/2018	cm ⁻¹		Source Well	MB154		0.090	8-2
Level-1	UV254	12/27/2018	cm ⁻¹		Source Well	MB159		0.078	8-6
Level-1	SIntRegI	12/20/2018	au		Source Well	NWH3		1959.2	9-3
Level-1	SIntRegI	12/20/2018	au		Source Well	NWH4		2211.5	9-3
Level-1	SIntRegI	12/20/2018	au		Source Well	CC4		1302.7	3-1
Level-1	SIntRegII	12/20/2018	au		Source Well	NWH3		12317.8	9-3
Level-1	SIntRegII	12/20/2018	au		Source Well	NWH4		13480.6	9-3
Level-1	SIntRegII	12/20/2018	au		Source Well	CC4		6797.4	3-1
Level-1	SIntRegIII	12/20/2018	au		Source Well	NWH3		14749.4	9-3
Level-1	SIntRegIII	12/20/2018	au		Source Well	NWH4		16179.2	9-3
Level-1	SIntRegIII	12/20/2018	au		Source Well	CC4		8764.9	3-1
Level-1	UV254	12/20/2018	cm ⁻¹		Source Well	NWH3		0.093	9-3
Level-1	UV254	12/20/2018	cm ⁻¹		Source Well	NWH4		0.101	9-3
Level-1	UV254	12/20/2018	cm ⁻¹		Source Well	CC4		0.069	3-1
Level-1	SIntRegI	12/19/2018	au		Source Well	NWH5		2132.6	9-4
Level-1	SIntRegI	12/19/2018	au		Source Well	S-21-#8		2185.1	10-1
Level-1	SIntRegI	12/19/2018	au		Source Well	S-21-#10		2136.9	10-1
Level-1	SIntRegI	12/19/2018	au		Source Well	CRLWD1		1526.0	5-1
Level-1	SIntRegI	12/19/2018	au		Source Well	CRLWD2		1401.8	5-1
Level-1	SIntRegI	12/19/2018	au		Source Well	CRLWD3		1338.0	5-1
Level-1	SIntRegII	12/19/2018	au		Source Well	NWH5		12655.3	9-4
Level-1	SIntRegII	12/19/2018	au		Source Well	S-21-#8		14150.7	10-1
Level-1	SIntRegII	12/19/2018	au		Source Well	S-21-#10		13744.0	10-1

Level	Analyte	Date	Final Unit	Qualifier	Type	Sample Name	MDL	Result	Group
Level-1	SIntRegII	12/19/2018	au		Source Well	CRLWD1		8872.2	5-1
Level-1	SIntRegII	12/19/2018	au		Source Well	CRLWD2		8286.5	5-1
Level-1	SIntRegII	12/19/2018	au		Source Well	CRLWD3		7097.5	5-1
Level-1	SIntRegIII	12/19/2018	au		Source Well	NWH5		15208.0	9-4
Level-1	SIntRegIII	12/19/2018	au		Source Well	S-21-#8		16855.9	10-1
Level-1	SIntRegIII	12/19/2018	au		Source Well	S-21-#10		16700.9	10-1
Level-1	SIntRegIII	12/19/2018	au		Source Well	CRLWD1		10993.7	5-1
Level-1	SIntRegIII	12/19/2018	au		Source Well	CRLWD2		10142.2	5-1
Level-1	SIntRegIII	12/19/2018	au		Source Well	CRLWD3		8774.6	5-1
Level-1	UV254	12/19/2018	cm ⁻¹		Source Well	NWH5		0.098	9-4
Level-1	UV254	12/19/2018	cm ⁻¹		Source Well	S-21-#8		0.116	10-1
Level-1	UV254	12/19/2018	cm ⁻¹		Source Well	S-21-#10		0.116	10-1
Level-1	UV254	12/19/2018	cm ⁻¹		Source Well	CRLWD1		0.090	5-1
Level-1	UV254	12/19/2018	cm ⁻¹		Source Well	CRLWD2		0.067	5-1
Level-1	UV254	12/19/2018	cm ⁻¹		Source Well	CRLWD3		0.063	5-1
Level-1	SIntRegI	12/18/2018	au		Source Well	CB1		1743.6	2-9
Level-1	SIntRegI	12/18/2018	au		Source Well	CB7		1701.5	2-8
Level-1	SIntRegII	12/18/2018	au		Source Well	CB1		7440.5	2-9
Level-1	SIntRegII	12/18/2018	au		Source Well	CB7		7678.7	2-8
Level-1	SIntRegIII	12/18/2018	au		Source Well	CB1		9686.0	2-9
Level-1	SIntRegIII	12/18/2018	au		Source Well	CB7		9981.2	2-8
Level-1	UV254	12/18/2018	cm ⁻¹		Source Well	CB1		0.052	2-9
Level-1	UV254	12/18/2018	cm ⁻¹		Source Well	CB7		0.054	2-8
Level-1	SIntRegI	12/18/2018	au		Source Well	ELW110		2520.0	7-6
Level-1	SIntRegI	12/18/2018	au		Source Well	ELW113		2681.3	7-6
Level-1	SIntRegI	12/18/2018	au		Source Well	ELW137		2510.4	7-6
Level-1	SIntRegI	12/18/2018	au		Source Well	ELW140		2533.0	7-3
Level-1	SIntRegI	12/18/2018	au		Source Well	ELW141		2562.2	7-3
Level-1	SIntRegII	12/18/2018	au		Source Well	ELW110		14897.8	7-6
Level-1	SIntRegII	12/18/2018	au		Source Well	ELW113		15564.2	7-6
Level-1	SIntRegII	12/18/2018	au		Source Well	ELW137		14783.4	7-6
Level-1	SIntRegII	12/18/2018	au		Source Well	ELW140		15365.9	7-3
Level-1	SIntRegII	12/18/2018	au		Source Well	ELW141		15990.8	7-3
Level-1	SIntRegIII	12/18/2018	au		Source Well	ELW110		18036.2	7-6
Level-1	SIntRegIII	12/18/2018	au		Source Well	ELW113		18727.7	7-6
Level-1	SIntRegIII	12/18/2018	au		Source Well	ELW137		17917.0	7-6
Level-1	SIntRegIII	12/18/2018	au		Source Well	ELW140		18706.8	7-3
Level-1	SIntRegIII	12/18/2018	au		Source Well	ELW141		19352.5	7-3
Level-1	UV254	12/18/2018	cm ⁻¹		Source Well	ELW110		0.123	7-6
Level-1	UV254	12/18/2018	cm ⁻¹		Source Well	ELW113		0.125	7-6
Level-1	UV254	12/18/2018	cm ⁻¹		Source Well	ELW137		0.121	7-6
Level-1	UV254	12/18/2018	cm ⁻¹		Source Well	ELW140		0.129	7-3
Level-1	UV254	12/18/2018	cm ⁻¹		Source Well	ELW141		0.137	7-3
Level-1	SIntRegI	12/17/2018	au		Source Well	CC10		1733.5	3-4
Level-1	SIntRegI	12/17/2018	au		Source Well	CC9		1253.2	3-2
Level-1	SIntRegI	12/17/2018	au		Source Well	CY4		872.0	6-1
Level-1	SIntRegI	12/17/2018	au		Source Well	CY9		1259.9	6-1
Level-1	SIntRegI	12/17/2018	au		Source Well	SCH1		1520.7	11-1
Level-1	SIntRegI	12/17/2018	au		Source Well	SCH14		1386.4	11-8
Level-1	SIntRegI	12/17/2018	au		Source Well	SCH8		1342.8	11-2
Level-1	SIntRegI	12/17/2018	au		Source Well	CC1		1537.8	3-1
Level-1	SIntRegI	12/17/2018	au		Source Well	CC2		1470.0	3-2
Level-1	SIntRegI	12/17/2018	au		Source Well	CC3		1781.7	3-3
Level-1	SIntRegI	12/17/2018	au		Source Well	CC11		2136.6	3-5
Level-1	SIntRegI	12/17/2018	au		Source Well	CC6		1775.2	3-3
Level-1	SIntRegI	12/17/2018	au		Source Well	CY8		1370.7	6-2
Level-1	SIntRegI	12/17/2018	au		Source Well	CY11		1017.8	6-1
Level-1	SIntRegI	12/17/2018	au		Source Well	CB2		1609.5	2-8
Level-1	SIntRegII	12/17/2018	au		Source Well	CC10		10964.7	3-4
Level-1	SIntRegII	12/17/2018	au		Source Well	CC9		7448.8	3-2

Level	Analyte	Date	Final Unit	Qualifier	Type	Sample Name	MDL	Result	Group
Level-1	SIntRegII	12/17/2018	au		Source Well	CY4		4533.9995	6-1
Level-1	SIntRegII	12/17/2018	au		Source Well	CY9		5406.5	6-1
Level-1	SIntRegII	12/17/2018	au		Source Well	SCH1		5116.1	11-1
Level-1	SIntRegII	12/17/2018	au		Source Well	SCH14		5104.8	11-8
Level-1	SIntRegII	12/17/2018	au		Source Well	SCH8		6009.2	11-2
Level-1	SIntRegII	12/17/2018	au		Source Well	CC1		7156.5	3-1
Level-1	SIntRegII	12/17/2018	au		Source Well	CC2		6668.0	3-2
Level-1	SIntRegII	12/17/2018	au		Source Well	CC3		7843.7	3-3
Level-1	SIntRegII	12/17/2018	au		Source Well	CC11		14030.004	3-5
Level-1	SIntRegII	12/17/2018	au		Source Well	CC6		8111.8	3-3
Level-1	SIntRegII	12/17/2018	au		Source Well	CY8		7089.0	6-2
Level-1	SIntRegII	12/17/2018	au		Source Well	CY11		4389.9	6-1
Level-1	SIntRegII	12/17/2018	au		Source Well	CB2		6960.7	2-8
Level-1	SIntRegIII	12/17/2018	au		Source Well	CC10		13560.5	3-4
Level-1	SIntRegIII	12/17/2018	au		Source Well	CC9		9271.4	3-2
Level-1	SIntRegIII	12/17/2018	au		Source Well	CY4		5598.2	6-1
Level-1	SIntRegIII	12/17/2018	au		Source Well	CY9		6710.6	6-1
Level-1	SIntRegIII	12/17/2018	au		Source Well	SCH1		6359.0	11-1
Level-1	SIntRegIII	12/17/2018	au		Source Well	SCH14		6424.5	11-8
Level-1	SIntRegIII	12/17/2018	au		Source Well	SCH8		7514.7	11-2
Level-1	SIntRegIII	12/17/2018	au		Source Well	CC1		9168.1	3-1
Level-1	SIntRegIII	12/17/2018	au		Source Well	CC2		8502.1	3-2
Level-1	SIntRegIII	12/17/2018	au		Source Well	CC3		10114.2	3-3
Level-1	SIntRegIII	12/17/2018	au		Source Well	CC11		17332.8	3-5
Level-1	SIntRegIII	12/17/2018	au		Source Well	CC6		10405.7	3-3
Level-1	SIntRegIII	12/17/2018	au		Source Well	CY8		8648.7	6-2
Level-1	SIntRegIII	12/17/2018	au		Source Well	CY11		5764.7	6-1
Level-1	SIntRegIII	12/17/2018	au		Source Well	CB2		9116.3	2-8
Level-1	UV254	12/17/2018	cm ⁻¹		Source Well	CC10		0.096	3-4
Level-1	UV254	12/17/2018	cm ⁻¹		Source Well	CC9		0.057	3-2
Level-1	UV254	12/17/2018	cm ⁻¹		Source Well	CY4		0.028	6-1
Level-1	UV254	12/17/2018	cm ⁻¹		Source Well	CY9		0.039	6-1
Level-1	UV254	12/17/2018	cm ⁻¹		Source Well	SCH1		0.037	11-1
Level-1	UV254	12/17/2018	cm ⁻¹		Source Well	SCH14		0.045	11-8
Level-1	UV254	12/17/2018	cm ⁻¹		Source Well	SCH8		0.034	11-2
Level-1	UV254	12/17/2018	cm ⁻¹		Source Well	CC1		0.063	3-1
Level-1	UV254	12/17/2018	cm ⁻¹		Source Well	CC2		0.056	3-2
Level-1	UV254	12/17/2018	cm ⁻¹		Source Well	CC3		0.067	3-3
Level-1	UV254	12/17/2018	cm ⁻¹		Source Well	CC11		0.134	3-5
Level-1	UV254	12/17/2018	cm ⁻¹		Source Well	CC6		0.068	3-3
Level-1	UV254	12/17/2018	cm ⁻¹		Source Well	CY8		0.045	6-2
Level-1	UV254	12/17/2018	cm ⁻¹		Source Well	CY11		0.031	6-1
Level-1	UV254	12/17/2018	cm ⁻¹		Source Well	CB2		0.047	2-8
Level-1	SIntRegI	12/17/2018	au		Source Well	CB10		899.4	2-1
Level-1	SIntRegII	12/17/2018	au		Source Well	CB10		5102.0	2-1
Level-1	SIntRegIII	12/17/2018	au		Source Well	CB10		6640.9	2-1
Level-1	UV254	12/17/2018	cm ⁻¹		Source Well	CB10		0.037	2-1
Level-1	SIntRegI	12/13/2018	au		Source Well	CB17		376.0	2-3
Level-1	SIntRegI	12/13/2018	au		Source Well	CC12		1297.4	3-3
Level-1	SIntRegII	12/13/2018	au		Source Well	CB17		1737.6	2-3
Level-1	SIntRegII	12/13/2018	au		Source Well	CC12		8668.3	3-3
Level-1	SIntRegIII	12/13/2018	au		Source Well	CB17		2286.9	2-3
Level-1	SIntRegIII	12/13/2018	au		Source Well	CC12		11194.6	3-3
Level-1	UV254	12/13/2018	cm ⁻¹		Source Well	CB17		0.008	2-3
Level-1	UV254	12/13/2018	cm ⁻¹		Source Well	CC12		0.082	3-3
Level-1	SIntRegI	12/12/2018	au		Source Well	CY6		489.5	6-3
Level-1	SIntRegI	12/12/2018	au		Source Well	CY6		694.0	6-3
Level-1	SIntRegI	12/12/2018	au		Source Well	MB155		1863.5	8-2
Level-1	SIntRegI	12/12/2018	au		Source Well	MB156		1439.5	8-4
Level-1	SIntRegI	12/12/2018	au		Source Well	MB162		1472.8	8-8

Level	Analyte	Date	Final Unit	Qualifier	Type	Sample Name	MDL	Result	Group
Level-1	SIntRegI	12/12/2018	au		Source Well	CB4		1205.1	2-1
Level-1	SIntRegI	12/12/2018	au		Source Well	CB5		1134.3	2-1
Level-1	SIntRegI	12/12/2018	au		Source Well	CB11		753.9	2-5
Level-1	SIntRegI	12/12/2018	au		Source Well	CB12		283.2	2-6
Level-1	SIntRegI	12/12/2018	au		Source Well	CB13		732.2	2-5
Level-1	SIntRegI	12/12/2018	au		Source Well	CB15		912.3	2-7
Level-1	SIntRegI	12/12/2018	au		Source Well	CB16		483.7	2-4
Level-1	SIntRegII	12/12/2018	au		Source Well	CY6		3062.1	6-3
Level-1	SIntRegII	12/12/2018	au		Source Well	CY6		2758.1	6-3
Level-1	SIntRegII	12/12/2018	au		Source Well	MB155		11540.8	8-2
Level-1	SIntRegII	12/12/2018	au		Source Well	MB156		8043.5	8-4
Level-1	SIntRegII	12/12/2018	au		Source Well	MB162		7809.8	8-8
Level-1	SIntRegII	12/12/2018	au		Source Well	CB4		6484.4	2-1
Level-1	SIntRegII	12/12/2018	au		Source Well	CB5		6050.7	2-1
Level-1	SIntRegII	12/12/2018	au		Source Well	CB11		3951.4	2-5
Level-1	SIntRegII	12/12/2018	au		Source Well	CB12		1377.7	2-6
Level-1	SIntRegII	12/12/2018	au		Source Well	CB13		3895.1	2-5
Level-1	SIntRegII	12/12/2018	au		Source Well	CB15		4670.7	2-7
Level-1	SIntRegII	12/12/2018	au		Source Well	CB16		2795.1	2-4
Level-1	SIntRegIII	12/12/2018	au		Source Well	CY6		3921.6	6-3
Level-1	SIntRegIII	12/12/2018	au		Source Well	CY6		3598.0	6-3
Level-1	SIntRegIII	12/12/2018	au		Source Well	MB155		14468.4	8-2
Level-1	SIntRegIII	12/12/2018	au		Source Well	MB156		10335.2	8-4
Level-1	SIntRegIII	12/12/2018	au		Source Well	MB162		10044.9	8-8
Level-1	SIntRegIII	12/12/2018	au		Source Well	CB4		8429.4	2-1
Level-1	SIntRegIII	12/12/2018	au		Source Well	CB5		7907.5	2-1
Level-1	SIntRegIII	12/12/2018	au		Source Well	CB11		5223.0	2-5
Level-1	SIntRegIII	12/12/2018	au		Source Well	CB12		1884.0	2-6
Level-1	SIntRegIII	12/12/2018	au		Source Well	CB13		5126.2	2-5
Level-1	SIntRegIII	12/12/2018	au		Source Well	CB15		5903.0	2-7
Level-1	SIntRegIII	12/12/2018	au		Source Well	CB16		3622.4	2-4
Level-1	UV254	12/12/2018	cm ⁻¹		Source Well	CY6		0.023	6-3
Level-1	UV254	12/12/2018	cm ⁻¹		Source Well	CY6		0.021	6-3
Level-1	UV254	12/12/2018	cm ⁻¹		Source Well	MB155		0.107	8-2
Level-1	UV254	12/12/2018	cm ⁻¹		Source Well	MB156		0.067	8-4
Level-1	UV254	12/12/2018	cm ⁻¹		Source Well	MB162		0.065	8-8
Level-1	UV254	12/12/2018	cm ⁻¹		Source Well	CB4		0.043	2-1
Level-1	UV254	12/12/2018	cm ⁻¹		Source Well	CB5		0.041	2-1
Level-1	UV254	12/12/2018	cm ⁻¹		Source Well	CB11		0.025	2-5
Level-1	UV254	12/12/2018	cm ⁻¹		Source Well	CB12		0.006	2-6
Level-1	UV254	12/12/2018	cm ⁻¹		Source Well	CB13		0.024	2-5
Level-1	UV254	12/12/2018	cm ⁻¹		Source Well	CB15		0.031	2-7
Level-1	UV254	12/12/2018	cm ⁻¹		Source Well	CB16		0.015	2-4
Level-1	SIntRegI	12/3/2018	au		Source Well	SCH2		1169.7	11-2
Level-1	SIntRegI	12/3/2018	au		Source Well	SCH4		1246.1	11-2
Level-1	SIntRegI	12/3/2018	au		Source Well	SCH5		1366.2	11-2
Level-1	SIntRegI	12/3/2018	au		Source Well	SCH7		1240.0	11-1
Level-1	SIntRegII	12/3/2018	au		Source Well	SCH2		5508.8	11-2
Level-1	SIntRegII	12/3/2018	au		Source Well	SCH4		5709.9	11-2
Level-1	SIntRegII	12/3/2018	au		Source Well	SCH5		6462.7	11-2
Level-1	SIntRegII	12/3/2018	au		Source Well	SCH7		6266.8	11-1
Level-1	SIntRegIII	12/3/2018	au		Source Well	SCH2		6978.5	11-2
Level-1	SIntRegIII	12/3/2018	au		Source Well	SCH4		7183.9	11-2
Level-1	SIntRegIII	12/3/2018	au		Source Well	SCH5		8207.8	11-2
Level-1	SIntRegIII	12/3/2018	au		Source Well	SCH7		7891.9	11-1
Level-1	UV254	12/3/2018	cm ⁻¹		Source Well	SCH2		0.031	11-2
Level-1	UV254	12/3/2018	cm ⁻¹		Source Well	SCH4		0.034	11-2
Level-1	UV254	12/3/2018	cm ⁻¹		Source Well	SCH5		0.035	11-2
Level-1	UV254	12/3/2018	cm ⁻¹		Source Well	SCH7		0.044	11-1
Level-1	SIntRegI	11/29/2018	au		Source Well	SCH13		1192.9	11-7

Level	Analyte	Date	Final Unit	Qualifier	Type	Sample Name	MDL	Result	Group
Level-1	SIntRegI	11/29/2018	au		Source Well	SCH15		1238.3	11-7
Level-1	SIntRegI	11/29/2018	au		Source Well	SCH10		1363.9	11-2
Level-1	SIntRegII	11/29/2018	au		Source Well	SCH13		6103.4	11-7
Level-1	SIntRegII	11/29/2018	au		Source Well	SCH15		5475.0	11-7
Level-1	SIntRegII	11/29/2018	au		Source Well	SCH10		5952.8	11-2
Level-1	SIntRegIII	11/29/2018	au		Source Well	SCH13		7678.9	11-7
Level-1	SIntRegIII	11/29/2018	au		Source Well	SCH15		6890.9	11-7
Level-1	SIntRegIII	11/29/2018	au		Source Well	SCH10		7404.1	11-2
Level-1	UV254	11/29/2018	cm ⁻¹		Source Well	SCH13		0.045	11-7
Level-1	UV254	11/29/2018	cm ⁻¹		Source Well	SCH15		0.037	11-7
Level-1	UV254	11/29/2018	cm ⁻¹		Source Well	SCH10		0.037	11-2
Level-1	SIntRegI	11/28/2018	au		Source Well	ST10		3168.6	13-4
Level-1	SIntRegI	11/28/2018	au		Source Well	ELW101		2098.0	7-1
Level-1	SIntRegI	11/28/2018	au		Source Well	ELW103		2430.9	7-1
Level-1	SIntRegI	11/28/2018	au		Source Well	ELW105		2286.4	7-1
Level-1	SIntRegI	11/28/2018	au		Source Well	ELW106		2352.0	7-1
Level-1	SIntRegI	11/28/2018	au		Source Well	ELW107		2454.3	7-1
Level-1	SIntRegI	11/28/2018	au		Source Well	ELW131		2339.7	7-9
Level-1	SIntRegI	11/28/2018	au		Source Well	ELW136		2849.1	7-12
Level-1	SIntRegII	11/28/2018	au		Source Well	ST10		18334.8	13-4
Level-1	SIntRegII	11/28/2018	au		Source Well	ELW101		12644.4	7-1
Level-1	SIntRegII	11/28/2018	au		Source Well	ELW103		12907.6	7-1
Level-1	SIntRegII	11/28/2018	au		Source Well	ELW105		13125.4	7-1
Level-1	SIntRegII	11/28/2018	au		Source Well	ELW106		13680.4	7-1
Level-1	SIntRegII	11/28/2018	au		Source Well	ELW107		13675.0	7-1
Level-1	SIntRegII	11/28/2018	au		Source Well	ELW131		13527.4	7-9
Level-1	SIntRegII	11/28/2018	au		Source Well	ELW136		16671.7	7-12
Level-1	SIntRegIII	11/28/2018	au		Source Well	ST10		21614.8	13-4
Level-1	SIntRegIII	11/28/2018	au		Source Well	ELW101		15473.2	7-1
Level-1	SIntRegIII	11/28/2018	au		Source Well	ELW103		15673.6	7-1
Level-1	SIntRegIII	11/28/2018	au		Source Well	ELW105		15924.0	7-1
Level-1	SIntRegIII	11/28/2018	au		Source Well	ELW106		16590.4	7-1
Level-1	SIntRegIII	11/28/2018	au		Source Well	ELW107		16502.3	7-1
Level-1	SIntRegIII	11/28/2018	au		Source Well	ELW131		16513.3	7-9
Level-1	SIntRegIII	11/28/2018	au		Source Well	ELW136		20374.9	7-12
Level-1	UV254	11/28/2018	cm ⁻¹		Source Well	ST10		0.131	13-4
Level-1	UV254	11/28/2018	cm ⁻¹		Source Well	ELW101		0.100	7-1
Level-1	UV254	11/28/2018	cm ⁻¹		Source Well	ELW103		0.103	7-1
Level-1	UV254	11/28/2018	cm ⁻¹		Source Well	ELW105		0.098	7-1
Level-1	UV254	11/28/2018	cm ⁻¹		Source Well	ELW106		0.107	7-1
Level-1	UV254	11/28/2018	cm ⁻¹		Source Well	ELW107		0.102	7-1
Level-1	UV254	11/28/2018	cm ⁻¹		Source Well	ELW131		0.102	7-9
Level-1	UV254	11/28/2018	cm ⁻¹		Source Well	ELW136		0.127	7-12
Level-1	SIntRegI	11/27/2018	au		Source Well	BUD-2		1227.1	1-1
Level-1	SIntRegI	11/27/2018	au		Source Well	CO-1		2546.9	4-1
Level-1	SIntRegI	11/27/2018	au		Source Well	CO-3A		2594.8	4-3
Level-1	SIntRegI	11/27/2018	au		Source Well	CO-5		2727.8	4-3
Level-1	SIntRegI	11/27/2018	au		Source Well	CO-8		2716.0	4-1
Level-1	SIntRegI	11/27/2018	au		Source Well	CO-7A		3088.4	4-1
Level-1	SIntRegI	11/27/2018	au		Source Well	CO-21		2243.5	4-2
Level-1	SIntRegI	11/27/2018	au		Source Well	CO-16		2499.2	4-2
Level-1	SIntRegI	11/27/2018	au		Source Well	CO-18		2899.7	4-1
Level-1	SIntRegI	11/27/2018	au		Source Well	CO-34		3438.3	4-1
Level-1	SIntRegII	11/27/2018	au		Source Well	BUD-2		6893.9	1-1
Level-1	SIntRegII	11/27/2018	au		Source Well	CO-1		16157.5	4-1
Level-1	SIntRegII	11/27/2018	au		Source Well	CO-3A		16938.2	4-3
Level-1	SIntRegII	11/27/2018	au		Source Well	CO-5		17042.8	4-3
Level-1	SIntRegII	11/27/2018	au		Source Well	CO-8		17441.0	4-1
Level-1	SIntRegII	11/27/2018	au		Source Well	CO-7A		19222.7	4-1
Level-1	SIntRegII	11/27/2018	au		Source Well	CO-21		14132.2	4-2

Level	Analyte	Date	Final Unit	Qualifier	Type	Sample Name	MDL	Result	Group
Level-1	SIntRegII	11/27/2018	au		Source Well	CO-16		14834.0	4-2
Level-1	SIntRegII	11/27/2018	au		Source Well	CO-18		18264.2	4-1
Level-1	SIntRegII	11/27/2018	au		Source Well	CO-34		21852.9	4-1
Level-1	SIntRegIII	11/27/2018	au		Source Well	BUD-2		8791.6	1-1
Level-1	SIntRegIII	11/27/2018	au		Source Well	CO-1		19222.2	4-1
Level-1	SIntRegIII	11/27/2018	au		Source Well	CO-3A		20105.0	4-3
Level-1	SIntRegIII	11/27/2018	au		Source Well	CO-5		20229.2	4-3
Level-1	SIntRegIII	11/27/2018	au		Source Well	CO-8		20781.5	4-1
Level-1	SIntRegIII	11/27/2018	au		Source Well	CO-7A		22855.4	4-1
Level-1	SIntRegIII	11/27/2018	au		Source Well	CO-21		16827.8	4-2
Level-1	SIntRegIII	11/27/2018	au		Source Well	CO-16		17653.6	4-2
Level-1	SIntRegIII	11/27/2018	au		Source Well	CO-18		21683.8	4-1
Level-1	SIntRegIII	11/27/2018	au		Source Well	CO-34		25882.7	4-1
Level-1	UV254	11/27/2018	cm ⁻¹		Source Well	BUD-2		0.050	1-1
Level-1	UV254	11/27/2018	cm ⁻¹		Source Well	CO-1		0.123	4-1
Level-1	UV254	11/27/2018	cm ⁻¹		Source Well	CO-3A		0.119	4-3
Level-1	UV254	11/27/2018	cm ⁻¹		Source Well	CO-5		0.121	4-3
Level-1	UV254	11/27/2018	cm ⁻¹		Source Well	CO-8		0.133	4-1
Level-1	UV254	11/27/2018	cm ⁻¹		Source Well	CO-7A		0.135	4-1
Level-1	UV254	11/27/2018	cm ⁻¹		Source Well	CO-21		0.106	4-2
Level-1	UV254	11/27/2018	cm ⁻¹		Source Well	CO-16		0.107	4-2
Level-1	UV254	11/27/2018	cm ⁻¹		Source Well	CO-18		0.132	4-1
Level-1	UV254	11/27/2018	cm ⁻¹		Source Well	CO-34		0.147	4-1
Level-1	SIntRegI	11/26/2018	au		Source Well	BUD-4		186.2	1-2
Level-1	SIntRegI	11/26/2018	au		Source Well	BUD-6		436.6	1-2
Level-1	SIntRegI	11/26/2018	au		Source Well	BUD-7		198.8	1-4
Level-1	SIntRegII	11/26/2018	au		Source Well	BUD-4		497.5	1-2
Level-1	SIntRegII	11/26/2018	au		Source Well	BUD-6		560.0	1-2
Level-1	SIntRegII	11/26/2018	au		Source Well	BUD-7		456.2	1-4
Level-1	SIntRegIII	11/26/2018	au		Source Well	BUD-4		630.4	1-2
Level-1	SIntRegIII	11/26/2018	au		Source Well	BUD-6		638.2	1-2
Level-1	SIntRegIII	11/26/2018	au		Source Well	BUD-7		564.0	1-4
Level-1	UV254	11/26/2018	cm ⁻¹		Source Well	BUD-4		0.005	1-2
Level-1	UV254	11/26/2018	cm ⁻¹		Source Well	BUD-6		0.007	1-2
Level-1	UV254	11/26/2018	cm ⁻¹		Source Well	BUD-7		0.004	1-4
Level-2	Total Organic Carbon (TOC)	2/28/2019	mg/L		Source Well	BUD-2		2.01	1-1
Level-2	UV254	2/28/2019	cm ⁻¹		Source Well	BUD-2		0.045	1-1
Level-2	THMFP	2/28/2019	ppb		Source Well	BUD-2		142	1-1
Level-2	Total Organic Carbon (TOC)	2/28/2019	mg/L		Source Well	BUD-6		0.45	1-2
Level-2	UV254	2/28/2019	cm ⁻¹	U	Source Well	BUD-6		0.005	1-2
Level-2	THMFP	2/28/2019	ppb		Source Well	BUD-6		14.5	1-2
Level-2	Total Organic Carbon (TOC)	2/28/2019	mg/L		Source Well	BUD-5R		1.14	1-3
Level-2	UV254	2/28/2019	cm ⁻¹		Source Well	BUD-5R		0.045	1-3
Level-2	THMFP	2/28/2019	ppb		Source Well	BUD-5R		89.6	1-3
Level-2	Total Organic Carbon (TOC)	2/28/2019	mg/L		Source Well	BUD-7		0.405	1-4
Level-2	UV254	2/28/2019	cm ⁻¹		Source Well	BUD-7		0.018	1-4
Level-2	THMFP	2/28/2019	ppb		Source Well	BUD-7		14.7	1-4
Level-2	Total Organic Carbon (TOC)	2/28/2019	mg/L		Source Well	CO-8		4.62	4-1
Level-2	UV254	2/28/2019	cm ⁻¹		Source Well	CO-8		0.14	4-1
Level-2	THMFP	2/28/2019	ppb		Source Well	CO-8		330	4-1
Level-2	Total Organic Carbon (TOC)	2/28/2019	mg/L		Source Well	CO-16		3.47	4-2
Level-2	UV254	2/28/2019	cm ⁻¹		Source Well	CO-16		0.12	4-2
Level-2	THMFP	2/28/2019	ppb		Source Well	CO-16		239	4-2
Level-2	Total Organic Carbon (TOC)	2/28/2019	mg/L		Source Well	CO-31		4.14	4-4
Level-2	UV254	2/28/2019	cm ⁻¹		Source Well	CO-31		0.19	4-4
Level-2	THMFP	2/28/2019	ppb		Source Well	CO-31		272	4-4

Level	Analyte	Date	Final Unit	Qualifier	Type	Sample Name	MDL	Result	Group
Level-2	Total Organic Carbon (TOC)	2/28/2019	mg/L		Source Well	CO-25		4.07	4-5
Level-2	UV254	2/28/2019	cm ⁻¹		Source Well	CO-25		0.13	4-5
Level-2	THMFP	2/28/2019	ppb		Source Well	CO-25		268	4-5
Level-2	Total Organic Carbon (TOC)	2/28/2019	mg/L		Source Well	CY4		1.45	6-1
Level-2	UV254	2/28/2019	cm ⁻¹		Source Well	CY4		0.034	6-1
Level-2	THMFP	2/28/2019	ppb		Source Well	CY4		98.2	6-1
Level-2	Total Organic Carbon (TOC)	2/28/2019	mg/L		Source Well	CY6		1.28	6-3
Level-2	UV254	2/28/2019	cm ⁻¹		Source Well	CY6		0.028	6-3
Level-2	THMFP	2/28/2019	ppb		Source Well	CY6		78.8	6-3
Level-2	Total Organic Carbon (TOC)	2/28/2019	mg/L		Source Well	ELW107		3.57	7-1
Level-2	UV254	2/28/2019	cm ⁻¹		Source Well	ELW107		0.1	7-1
Level-2	THMFP	2/28/2019	ppb		Source Well	ELW107		259	7-1
Level-2	Total Organic Carbon (TOC)	2/28/2019	mg/L		Source Well	ELW9		4.15	7-2
Level-2	UV254	2/28/2019	cm ⁻¹		Source Well	ELW9		0.16	7-2
Level-2	THMFP	2/28/2019	ppb		Source Well	ELW9		319	7-2
Level-2	Total Organic Carbon (TOC)	2/28/2019	mg/L		Source Well	ELW142		4.97	7-3
Level-2	UV254	2/28/2019	cm ⁻¹		Source Well	ELW142		0.15	7-3
Level-2	THMFP	2/28/2019	ppb		Source Well	ELW142		336	7-3
Level-2	Total Organic Carbon (TOC)	2/28/2019	mg/L		Source Well	ELW10A		3.51	7-4
Level-2	UV254	2/28/2019	cm ⁻¹		Source Well	ELW10A		0.12	7-4
Level-2	THMFP	2/28/2019	ppb		Source Well	ELW10A		267	7-4
Level-2	Total Organic Carbon (TOC)	2/28/2019	mg/L		Source Well	ELW13		4.05	7-5
Level-2	UV254	2/28/2019	cm ⁻¹		Source Well	ELW13		0.15	7-5
Level-2	THMFP	2/28/2019	ppb		Source Well	ELW13		270	7-5
Level-2	Total Organic Carbon (TOC)	2/28/2019	mg/L		Source Well	MB157		3.65	8-2
Level-2	UV254	2/28/2019	cm ⁻¹		Source Well	MB157		0.1	8-2
Level-2	THMFP	2/28/2019	ppb		Source Well	MB157		244	8-2
Level-2	Total Organic Carbon (TOC)	2/28/2019	mg/L		Source Well	MB156		3.18	8-4
Level-2	UV254	2/28/2019	cm ⁻¹		Source Well	MB156		0.08	8-4
Level-2	THMFP	2/28/2019	ppb		Source Well	MB156		208	8-4
Level-2	Total Organic Carbon (TOC)	2/28/2019	mg/L		Source Well	S-21-#8		3.67	10-1
Level-2	UV254	2/28/2019	cm ⁻¹		Source Well	S-21-#8		0.13	10-1
Level-2	THMFP	2/28/2019	ppb		Source Well	S-21-#8		266	10-1
Level-2	Total Organic Carbon (TOC)	2/28/2019	mg/L		Source Well	SCH13		1.41	11-7
Level-2	UV254	2/28/2019	cm ⁻¹		Source Well	SCH13		0.096	11-7
Level-2	THMFP	2/28/2019	ppb		Source Well	SCH13		102	11-7
Level-2	Total Organic Carbon (TOC)	2/28/2019	mg/L		Source Well	SCH14		1.34	11-8
Level-2	UV254	2/28/2019	cm ⁻¹		Source Well	SCH14		0.066	11-8
Level-2	THMFP	2/28/2019	ppb		Source Well	SCH14		81.9	11-8
Level-2	Total Organic Carbon (TOC)	3/5/2019	mg/L		Source Well	CB17		0.825	2-3
Level-2	UV254	3/5/2019	cm ⁻¹		Source Well	CB17		0.012	2-3
Level-2	THMFP	3/5/2019	ppb		Source Well	CB17		42.1	2-3
Level-2	Total Organic Carbon (TOC)	3/5/2019	mg/L		Source Well	CB12		0.833	2-6
Level-2	UV254	3/5/2019	cm ⁻¹		Source Well	CB12		0.01	2-6
Level-2	THMFP	3/5/2019	ppb		Source Well	CB12		35.8	2-6
Level-2	Total Organic Carbon (TOC)	3/5/2019	mg/L		Source Well	CY8		1.79	6-2
Level-2	UV254	3/5/2019	cm ⁻¹		Source Well	CY8		0.045	6-2
Level-2	THMFP	3/5/2019	ppb		Source Well	CY8		113	6-2
Level-2	Total Organic Carbon (TOC)	3/5/2019	mg/L		Source Well	CC10		3.69	3-4
Level-2	UV254	3/5/2019	cm ⁻¹		Source Well	CC10		0.075	3-4

Level	Analyte	Date	Final Unit	Qualifier	Type	Sample Name	MDL	Result	Group
Level-2	THMFP	3/5/2019	ppb		Source Well	CC10		210	3-4
Level-2	Total Organic Carbon (TOC)	3/5/2019	mg/L		Source Well	MB151		3.27	8-3
Level-2	UV254	3/5/2019	cm ⁻¹		Source Well	MB151		0.066	8-3
Level-2	THMFP	3/5/2019	ppb		Source Well	MB151		157	8-3
Level-2	Total Organic Carbon (TOC)	3/6/2019	mg/L		POE	RSWTPEFF		1.95	#N/A
Level-2	UV254	3/6/2019	cm ⁻¹		POE	RSWTPEFF		0.022	#N/A
Level-2	THMFP	3/6/2019	ppb		POE	RSWTPEFF		158	#N/A
Level-2	Total Organic Carbon (TOC)	3/6/2019	mg/L	U	fore Blend with	DESALEFF		0.09	#N/A
Level-2	UV254	3/6/2019	cm ⁻¹	U	fore Blend with	DESALEFF		0.005	#N/A
Level-2	THMFP	3/6/2019	ppb		POE/Before Blend with	DESALEFF		3.54	#N/A
Level-2	Total Organic Carbon (TOC)	3/7/2019	mg/L		Source Well	CB16		1.08	2-4
Level-2	UV254	3/7/2019	cm ⁻¹		Source Well	CB16		0.066	2-4
Level-2	THMFP	3/7/2019	ppb		Source Well	CB16		59.1	2-4
Level-2	Total Organic Carbon (TOC)	3/7/2019	mg/L		Source Well	CB11		1.61	2-5
Level-2	UV254	3/7/2019	cm ⁻¹		Source Well	CB11		0.03	2-5
Level-2	THMFP	3/7/2019	ppb		Source Well	CB11		91.5	2-5
Level-2	Total Organic Carbon (TOC)	3/7/2019	mg/L		Source Well	CB15		1.5	2-7
Level-2	UV254	3/7/2019	cm ⁻¹		Source Well	CB15		0.039	2-7
Level-2	THMFP	3/7/2019	ppb		Source Well	CB15		89	2-7
Level-2	Total Organic Carbon (TOC)	3/7/2019	mg/L		Source Well	CB1		2.54	2-9
Level-2	UV254	3/7/2019	cm ⁻¹		Source Well	CB1		0.077	2-9
Level-2	THMFP	3/7/2019	ppb		Source Well	CB1		122	2-9
Level-2	Total Organic Carbon (TOC)	3/7/2019	mg/L		Source Well	CC1		2.42	3-1
Level-2	UV254	3/7/2019	cm ⁻¹		Source Well	CC1		0.086	3-1
Level-2	THMFP	3/7/2019	ppb		Source Well	CC1		172	3-1
Level-2	Total Organic Carbon (TOC)	3/7/2019	mg/L		Source Well	CC2		2.54	3-2
Level-2	UV254	3/7/2019	cm ⁻¹		Source Well	CC2		0.058	3-2
Level-2	THMFP	3/7/2019	ppb		Source Well	CC2		147	3-2
Level-2	Total Organic Carbon (TOC)	3/7/2019	mg/L		Source Well	CC6		2.87	3-3
Level-2	UV254	3/7/2019	cm ⁻¹		Source Well	CC6		0.07	3-3
Level-2	THMFP	3/7/2019	ppb		Source Well	CC6		156	3-3
Level-2	Total Organic Carbon (TOC)	3/7/2019	mg/L		Source Well	CC11		5.22	3-5
Level-2	UV254	3/7/2019	cm ⁻¹		Source Well	CC11		0.19	3-5
Level-2	THMFP	3/7/2019	ppb		Source Well	CC11		290	3-5
Level-2	Total Organic Carbon (TOC)	3/7/2019	mg/L		Source Well	S-21-#5		2.96	10-2
Level-2	UV254	3/7/2019	cm ⁻¹		Source Well	S-21-#5		0.1	10-2
Level-2	THMFP	3/7/2019	ppb		Source Well	S-21-#5		172	10-2
Level-2	Total Organic Carbon (TOC)	3/7/2019	mg/L		Source Well	SCH7		1.49	11-1
Level-2	UV254	3/7/2019	cm ⁻¹		Source Well	SCH7		0.076	11-1
Level-2	THMFP	3/7/2019	ppb		Source Well	SCH7		80.4	11-1
Level-2	Total Organic Carbon (TOC)	3/7/2019	mg/L		Source Well	SCH5		1.49	11-2
Level-2	UV254	3/7/2019	cm ⁻¹		Source Well	SCH5		0.037	11-2
Level-2	THMFP	3/7/2019	ppb		Source Well	SCH5		85	11-2
Level-2	Total Organic Carbon (TOC)	3/20/2019	mg/L		Source Well	ELW113		3.8	7-6
Level-2	UV254	3/20/2019	cm ⁻¹		Source Well	ELW113		0.042	7-6
Level-2	THMFP	3/20/2019	ppb		Source Well	ELW113		235	7-6
Level-2	Total Organic Carbon (TOC)	3/20/2019	mg/L		Source Well	ELW116		3.64	7-7
Level-2	UV254	3/20/2019	cm ⁻¹		Source Well	ELW116		0.094	7-7
Level-2	THMFP	3/20/2019	ppb		Source Well	ELW116		230	7-7
Level-2	Total Organic Carbon (TOC)	3/20/2019	mg/L		Source Well	ELW121		2.55	7-8

Level	Analyte	Date	Final Unit	Qualifier	Type	Sample Name	MDL	Result	Group
Level-2	UV254	3/20/2019	cm ⁻¹		Source Well	ELW121		0.11	7-8
Level-2	THMFP	3/20/2019	ppb		Source Well	ELW121		171	7-8
Level-2	Total Organic Carbon (TOC)	3/20/2019	mg/L		Source Well	ELW131		3.62	7-9
Level-2	UV254	3/20/2019	cm ⁻¹		Source Well	ELW131		0.1	7-9
Level-2	THMFP	3/20/2019	ppb		Source Well	ELW131		226	7-9
Level-2	Total Organic Carbon (TOC)	3/20/2019	mg/L		Source Well	ELW134		3.54	7-10
Level-2	UV254	3/20/2019	cm ⁻¹		Source Well	ELW134		0.13	7-10
Level-2	THMFP	3/20/2019	ppb		Source Well	ELW134		222	7-10
Level-2	Total Organic Carbon (TOC)	3/20/2019	mg/L		Source Well	ELW135		4.16	7-11
Level-2	UV254	3/20/2019	cm ⁻¹		Source Well	ELW135		0.14	7-11
Level-2	THMFP	3/20/2019	ppb		Source Well	ELW135		250	7-11
Level-2	Total Organic Carbon (TOC)	3/20/2019	mg/L		Source Well	ELW136		4.13	7-12
Level-2	UV254	3/20/2019	cm ⁻¹		Source Well	ELW136		0.11	7-12
Level-2	THMFP	3/20/2019	ppb		Source Well	ELW136		269	7-12
Level-2	Total Organic Carbon (TOC)	3/21/2019	mg/L		Source Well	CB7		2.6	2-8
Level-2	UV254	3/21/2019	cm ⁻¹		Source Well	CB7		0.1	2-8
Level-2	THMFP	3/21/2019	ppb		Source Well	CB7		145	2-8
Level-2	Total Organic Carbon (TOC)	3/21/2019	mg/L		Source Well	CO-5		3.63	4-3
Level-2	UV254	3/21/2019	cm ⁻¹		Source Well	CO-5		0.14	4-3
Level-2	THMFP	3/21/2019	ppb		Source Well	CO-5		244	4-3
Level-2	Total Organic Carbon (TOC)	3/21/2019	mg/L		Source Well	CRLWD2		2.36	5-1
Level-2	UV254	3/21/2019	cm ⁻¹		Source Well	CRLWD2		0.067	5-1
Level-2	THMFP	3/21/2019	ppb		Source Well	CRLWD2		168	5-1
Level-2	Total Organic Carbon (TOC)	3/21/2019	mg/L		Source Well	MB158		2.16	8-5
Level-2	UV254	3/21/2019	cm ⁻¹		Source Well	MB158		0.064	8-5
Level-2	THMFP	3/21/2019	ppb		Source Well	MB158		114	8-5
Level-2	Total Organic Carbon (TOC)	3/21/2019	mg/L		Source Well	NWH6		2.74	9-5
Level-2	UV254	3/21/2019	cm ⁻¹		Source Well	NWH6		0.13	9-5
Level-2	THMFP	3/21/2019	ppb		Source Well	NWH6		190	9-5
Level-2	Total Organic Carbon (TOC)	3/26/2019	mg/L		Source Well	NWH1		2.89	9-1
Level-2	UV254	3/26/2019	cm ⁻¹		Source Well	NWH1		0.094	9-1
Level-2	THMFP	3/26/2019	ppb		Source Well	NWH1		190	9-1
Level-2	Total Organic Carbon (TOC)	3/26/2019	mg/L		Source Well	NWH2		3.04	9-2
Level-2	UV254	3/26/2019	cm ⁻¹		Source Well	NWH2		0.12	9-2
Level-2	THMFP	3/26/2019	ppb		Source Well	NWH2		195	9-2
Level-2	Total Organic Carbon (TOC)	3/26/2019	mg/L		Source Well	ST6		4.33	13-3
Level-2	UV254	3/26/2019	cm ⁻¹		Source Well	ST6		0.13	13-3
Level-2	THMFP	3/26/2019	ppb		Source Well	ST6		284	13-3
Level-2	Total Organic Carbon (TOC)	3/26/2019	mg/L		Source Well	ST10		4.01	13-4
Level-2	UV254	3/26/2019	cm ⁻¹		Source Well	ST10		0.14	13-4
Level-2	THMFP	3/26/2019	ppb		Source Well	ST10		248	13-4
Level-2	Total Organic Carbon (TOC)	3/26/2019	mg/L		Source Well	ST9		4.41	13-5
Level-2	UV254	3/26/2019	cm ⁻¹		Source Well	ST9		0.12	13-5
Level-2	THMFP	3/26/2019	ppb		Source Well	ST9		253	13-5
Level-2	Total Organic Carbon (TOC)	3/27/2019	mg/L		Source Well	NWH3		3.17	9-3
Level-2	UV254	3/27/2019	cm ⁻¹		Source Well	NWH3		0.11	9-3
Level-2	THMFP	3/27/2019	ppb		Source Well	NWH3		198	9-3
Level-2	Total Organic Carbon (TOC)	3/27/2019	mg/L		Source Well	NWH5		3.08	9-4
Level-2	UV254	3/27/2019	cm ⁻¹		Source Well	NWH5		0.091	9-4
Level-2	THMFP	3/27/2019	ppb		Source Well	NWH5		189	9-4

Level	Analyte	Date	Final Unit	Qualifier	Type	Sample Name	MDL	Result	Group
Level-2	Total Organic Carbon (TOC)	3/27/2019	mg/L		Source Well	SP-50		4.82	12-1
Level-2	UV254	3/27/2019	cm ⁻¹		Source Well	SP-50		0.12	12-1
Level-2	THMFP	3/27/2019	ppb		Source Well	SP-50		317	12-1
Level-2	Total Organic Carbon (TOC)	3/27/2019	mg/L		Source Well	SP-49		3.9	12-3
Level-2	UV254	3/27/2019	cm ⁻¹		Source Well	SP-49		0.11	12-3
Level-2	THMFP	3/27/2019	ppb		Source Well	SP-49		264	12-3
Level-2	Total Organic Carbon (TOC)	7/26/2019	mg/L		Source Well	CB5		2.14	2-1
Level-2	UV254	7/26/2019	cm ⁻¹		Source Well	CB5		0.41	2-1