MASTER WATER SUPPLY CONTRACT

among

WEST COAST REGIONAL WATER SUPPLY AUTHORITY,

and

HILLSBOROUGH COUNTY, FLORIDA

and

CITY OF NEW PORT RICHEY, FLORIDA

and

PASCO COUNTY, FLORIDA

and

PINELLAS COUNTY, FLORIDA

and

CITY OF ST. PETERSBURG, FLORIDA

and

CITY OF TAMPA, FLORIDA

Dated as of May 1, 1998

TABLE OF CONTENTS

	<u>Page</u>
SECTION 1.	RECITALS..... 3
SECTION 2.	EXHIBITS..... 3
SECTION 3.	DEFINITIONS..... 5
SECTION 4.	TERM..... 14
SECTION 5.	CONDITIONS PRECEDENT..... 14
SECTION 6.	SATISFACTION OF THE CONDITIONS PRECEDENT..... 15
SECTION 7.	REPRESENTATIONS OF THE PARTIES..... 15
SECTION 8.	AUTHORITY'S AGREEMENT TO PROVIDE WATER SERVICE..... 17
SECTION 9.	MEMBER GOVERNMENTS' WATER SERVICE..... 19
SECTION 10.	POINTS OF CONNECTION AND METER LOCATIONS..... 20
SECTION 11.	METERING FACILITIES..... 22
SECTION 12.	ANNUAL REPORT..... 23
SECTION 13.	RATE..... 24
SECTION 14.	PLEDGE OF CONTRACT REVENUES..... 29
SECTION 15.	DEVELOPMENT OF NEW WATER SUPPLY SOURCES..... 30
SECTION 16.	MEMBER GOVERNMENTS' RIGHTS TO DEVELOP AND SUPPLY WATER..... 30
SECTION 17.	ADDITIONAL REPRESENTATIONS, WARRANTIES AND COVENANTS OF THE AUTHORITY..... 30
SECTION 18.	ADDITIONAL REPRESENTATIONS, WARRANTIES AND COVENANTS OF THE MEMBER GOVERNMENTS..... 32
SECTION 19.	ARBITRATION..... 35
SECTION 20.	AUTHORITY'S SOURCES OF WATER..... 39
SECTION 21.	DEFAULT AND REMEDY..... 39
SECTION 22.	DISPOSITION OF ASSETS UPON TERMINATION OF AUTHORITY..... 43
SECTION 23.	APPLICABLE LAW AND VENUE..... 43
SECTION 24.	ASSIGNMENT..... 43
SECTION 25.	NOTICES..... 43
SECTION 26.	THIRD-PARTY BENEFICIARIES..... 45
SECTION 27.	WAIVER..... 45
SECTION 28.	CAPTIONS AND REFERENCES..... 46
SECTION 29.	SEVERABILITY..... 46
SECTION 30.	AMENDMENT..... 46
SECTION 31.	NO OTHER AGREEMENTS..... 46
SECTION 32.	EXISTING AGREEMENTS..... 46
SECTION 33.	SUCCESSORS AND ASSIGNS..... 47
SECTION 34.	EXECUTION OF DOCUMENTS..... 47
SECTION 35.	INTERLOCAL AGREEMENT..... 47

SECTION 36.	OBLIGATIONS OF MEMBER GOVERNMENTS.....	47
SECTION 37.	CONFLICT WITH INTERLOCAL AGREEMENT.....	48
SECTION 38.	GOOD FAITH.....	48
SECTION 39.	MISCELLANEOUS PROVISIONS.....	48

EXHIBIT A	AUTHORITY'S SYSTEM
EXHIBIT B	MASTER WATER PLAN
EXHIBIT C	POINTS OF CONNECTION
EXHIBIT D	SUPPLEMENTAL WATER QUALITY PARAMETERS
EXHIBIT E	DESCRIPTION OF WATER SERVICE AREAS
EXHIBIT F	RATES
EXHIBIT G	TERMINATED AGREEMENTS
EXHIBIT H	SURVIVING AGREEMENTS
EXHIBIT I	MODIFIED AGREEMENTS
EXHIBIT J	SUPERSEDED AGREEMENTS
EXHIBIT K	FORM OF ANNUAL REPORT
EXHIBIT L	ARBITRATION DISCOVERY RULES

MASTER WATER SUPPLY CONTRACT

THIS MASTER WATER SUPPLY CONTRACT (the "Contract"), entered into as of this 1st day of May, 1998, by and among the **WEST COAST REGIONAL WATER SUPPLY AUTHORITY**, an interlocal governmental agency created and existing pursuant to Sections 373.1962 and 163.01, Florida Statutes (the "Authority"), as reorganized by that certain Amended and Restated Interlocal Agreement, dated as of May 1, 1998 (the "Interlocal Agreement"); **HILLSBOROUGH COUNTY, FLORIDA**, a political subdivision of the State of Florida ("Hillsborough"); the **CITY OF NEW PORT RICHEY, FLORIDA**, a municipal corporation of the State of Florida ("New Port Richey"); **PASCO COUNTY, FLORIDA**, a political subdivision of the State of Florida ("Pasco"); **PINELLAS COUNTY, FLORIDA**, a political subdivision of the State of Florida ("Pinellas"); the **CITY OF ST. PETERSBURG, FLORIDA**, a municipal corporation of the State of Florida ("St. Petersburg") and the **CITY OF TAMPA, FLORIDA**, a municipal corporation of the State of Florida ("Tampa") (Hillsborough, New Port Richey, Pasco, Pinellas, St. Petersburg and Tampa may sometimes be collectively referred to herein as the "Member Governments" and individually referred to as a "Member Government").

WHEREAS, the Authority was created by Hillsborough, Pasco, Pinellas, St. Petersburg and Tampa on October 25, 1974, as amended, for the purpose of developing, recovering, storing and supplying water for county and municipal purposes in such manner as will give priority to reducing the adverse environmental effects of excessive or improper withdrawals from concentrated areas; and

WHEREAS, as of May 1, 1998, the Member Governments reorganized the Authority pursuant to the Interlocal Agreement in order to establish the Authority as a water utility; and

WHEREAS, the Authority and the Member Governments currently own or lease, control and manage various water production, treatment and transmission facilities for the supply of water to customers of the Member Governments; and

WHEREAS, the Member Governments have heretofore determined that the Authority shall own, license or lease and operate various water production, treatment and transmission facilities (collectively, the "System"), including certain facilities currently owned, licensed or leased by Member Governments, for the common use and benefit of the Member Governments, in the manner specified in the Interlocal Agreement; and

WHEREAS, on the Effective Date (as defined herein) of this Contract the Member Governments shall have certain water needs; and

WHEREAS, the Authority agrees that it shall satisfy the aforementioned water needs of the Member Governments in accordance with the terms hereof; and

WHEREAS, the Member Governments desire the Authority to expand the System to meet the common needs of all of the Member Governments, in the manner specified herein and in the Interlocal Agreement; and

WHEREAS, the Member Governments desire to share the costs of operating, developing, acquiring, constructing, equipping and expanding the Authority's System in the manner specified herein and in the Interlocal Agreement; and

WHEREAS, the Member Governments desire to purchase and the Authority desires to sell water produced by the Authority from the System at a rate, as specified herein; and

WHEREAS, the Member Governments agree that this Contract shall supersede and replace various existing agreements described herein between the Authority and each of the Member Governments relating to supplying water upon issuance of the herein-described Series 1998 Bonds by the Authority; and

WHEREAS, such Series 1998 Bonds shall be secured in the manner provided herein and pursuant to the instrument by which they shall be issued; and

WHEREAS, the proceeds of the Series 1998 Bonds shall be used principally (1) to restructure the Authority's outstanding debt so that the terms hereof shall pertain to all water supplied by the Authority to the Member Governments, (2) to fund certain capital improvements to the System, and (3) to acquire certain Transferred Assets (as defined herein) from Member Governments;

NOW, THEREFORE, for and in consideration of the above premises, which shall be deemed an integral part of this Contract, and of the mutual covenants and agreements hereafter set forth, the Authority, Hillsborough, New Port Richey, Pasco, Pinellas, St. Petersburg and Tampa, intending to be legally bound, hereby agree as follows:

SECTION 1. RECITALS. The foregoing recitals are true and correct and are incorporated by reference herein and made a part hereof.

SECTION 2. EXHIBITS. Except as otherwise expressly provided herein, all Exhibits identified herein are made a part hereof and are incorporated herein by this

reference to the same extent as if fully set forth herein. Exhibits A and F may be amended or supplemented from time to time by the Authority in accordance with the terms hereof without approval by any Member Government. Exhibit B shall not be amended to reflect any change or modification to the Master Water Plan as the same may be made from time to time. Exhibit B is attached hereto for informational purposes only. Amendments to Exhibit C shall require the written consent of the Authority and any affected Member Government. For purposes of Exhibit C, a Member Government shall be considered affected if the amendment or supplement thereto directly affects the point or location at which such Member Government receives Quality Water from the Authority. The standards for the arbitration process provided in Exhibit D may only be changed with the consent of the Authority and all Member Governments. Specific water quality parameters in Exhibit D may be changed by the Authority without consent of the Member Governments, subsequent to arbitration by any Member Government as provided in Exhibit D; provided, however, the Authority agrees to comply with the results of any arbitration determinations relating to Water quality standards. Exhibit E may only be amended or supplemented by the Member Government which is modifying its Water Service Area, provided Authority approval shall be required under the circumstances described in the last sentence of Section 9 hereof. Exhibits G, H, I and J shall not be amended without the written consent of all parties hereto. Exhibit K is attached hereto for informational purposes only. No Exhibit hereto may be amended or supplemented in contravention to the terms of this Contract. All Exhibits shall be construed amended or supplemented upon delivery of a new Exhibit by the Authority to each Member

Government, with written consent where appropriate as described above. No amendment or supplement to the Exhibits hereto shall require the reexecution of this Contract.

SECTION 3. DEFINITIONS. Unless otherwise specifically set forth elsewhere in this Contract, the following words and phrases used in this Contract shall have the following meanings:

(A) **"Annual Estimate"** shall mean the estimate of the Authority Costs for a Fiscal Year, including the estimated amount thereof to be payable by each Member Government, and submitted to each Member Government on an annual basis, as required by Section 13 hereof. The Annual Estimate shall be based upon the Authority's proposed annual budget and estimated rate and shall consider the Annual Reports in determining the estimated amounts to be payable by the Member Governments.

(B) **"Annual Report"** or **"Annual Reports"** shall mean the report setting forth the next five (5) Fiscal Years of anticipated Water Service within the Water Service Areas for each of the Member Governments to be prepared by each such Member Government and submitted to the Authority as required by Section 12 hereof. The Annual Report may be amended by the Member Governments from time to time. The Annual Report shall be substantially in the form provided in Exhibit K hereto.

(C) **"Authority"** shall mean the West Coast Regional Water Supply Authority, an interlocal governmental agency created on October 25, 1974, and existing pursuant to Sections 373.1962 and 163.01, Florida Statutes, and pursuant to an interlocal agreement, among Hillsborough, Pasco, Pinellas, St. Petersburg and Tampa dated October 25, 1974, as amended, supplemented and reorganized pursuant to the Interlocal Agreement.

(D) **"Authority Costs"** shall mean Bond Coverage Costs, Capital Improvement Charges, Debt Service Charges, Operation, Maintenance and Administrative Costs, Operating Reserve Funds and Renewal and Replacement Charges.

(E) **"Authority's System"** or **"System"** shall mean the Authority's water production, transmission and treatment facilities, as they currently exist and as they may be modified or expanded in the future from time to time, which are owned, leased, licensed, operated and/or used by the Authority to provide Water. On the Effective Date hereof, the System shall consist of the facilities described in Exhibit A attached hereto. Such Exhibit A shall be amended or supplemented from time to time by the Authority to reflect any changes or modifications to such System.

(F) **"Bond Coverage Costs"** shall mean the costs of providing the coverage requirements established by the Financing Documents.

(G) **"Capital Improvement Charge"** shall mean the costs identified by the Authority for planning, designing, acquiring and constructing capital improvements to the System; provided such costs are not payable from proceeds of the Obligations (other than costs which are to be reimbursed from such proceeds) or from moneys received in relation to the Renewal and Replacement Charges.

(H) **"Debt Service Charges"** shall mean the principal, redemption premium, if any, and interest coming due on the Obligations and any recurring costs and expenses relating to the Obligations, including, but not limited to, paying agent, registrar and escrow agent fees, credit enhancement fees and other charges, but only to the extent such costs

and expenses are not otherwise reflected in Operation, Maintenance and Administrative Costs.

(I) **"DEP"** shall mean the Florida Department of Environmental Protection, a department and agency of the State of Florida, and any successor thereto.

(J) **"Effective Date"** shall mean the date on which all conditions precedent described in Section 5 hereof have been satisfied.

(K) **"Environmental Permits"** shall mean all permits, licenses or other third-party approvals necessary for the acquisition, construction or operation of an Authority Water Supply Facility, including, but not limited to, Primary Environmental Permits.

(L) **"Existing Authority System"** shall have the meaning provided therefor in the Interlocal Agreement.

(M) **"Financing Documents"** shall mean any resolution or resolutions of the Authority, as well as any indenture of trust, trust agreement or similar document relating to the issuance or security of the Obligations.

(N) **"Fiscal Year"** shall mean a twelve (12) month period which commences on October 1 of each year and ends on the next succeeding September 30, or such other period as may be prescribed by law as the fiscal year for the Authority.

(O) **"Fixed Costs"** shall mean all costs and expenses incurred by the Authority for the operation, maintenance, management, security, development and financing of the System other than Variable Costs.

(P) **"Full Implementation Date"** shall have the meaning provided therefor in the Interlocal Agreement.

(Q) **"Hillsborough"** shall mean Hillsborough County, Florida, a political subdivision of the State of Florida, acting by and through its Board of County Commissioners.

(R) **"Hillsborough's Water Service Area"** shall mean the geographic boundaries within which Hillsborough is permitted and authorized to provide Water Service.

(S) **"Inspection Report"** shall mean a report of the conditions and accuracy of the Metering Facilities which shall be prepared for the Authority by a representative of the manufacturer of the Metering Facilities or by a third-party selected by the Authority and which shall be submitted to the Member Governments as required by Section 11 hereof.

(T) **"Interlocal Agreement"** shall mean that certain Amended and Restated Interlocal Agreement, by and among the Member Governments, dated as of May 1, 1998, as the same may be amended or supplemented from time to time. Such Amended and Restated Interlocal Agreement shall be the successor instrument to the Interlocal Agreement, dated October 25, 1974, as amended, among Hillsborough, Pasco, Pinellas, St. Petersburg and Tampa.

(U) **"Long Term Forecast"** shall mean the forecast setting forth the next twenty (20) Fiscal Years of anticipated Water Service for each of the Member Governments for the development and use of their respective Water Service Areas, which Long Term Forecast shall be submitted to the Authority as of the Effective Date hereof. The Long Term Forecast may be amended by the Member Governments from time to time as part of the Annual Report.

(V) **"Master Water Plan"** shall mean the Authority's plan for expansion, conservation, diversification and preservation of Water supply for the Water Service Areas, as set forth in Exhibit B attached hereto, as the same may be amended or superseded from time to time.

(W) **"Member Governments"** shall mean, collectively, Hillsborough, New Port Richey, Pasco, Pinellas, St. Petersburg and Tampa.

(X) **"Metering Facilities"** shall mean, collectively, those certain water meters and appurtenant recording and transmitting devices to be installed and owned by the Authority, as required by Section 11 hereof, which are used to measure and bill the volume of Quality Water being delivered to each of the Member Governments.

(Y) **"New Port Richey"** shall mean the City of New Port Richey, Florida, a municipal corporation of the State of Florida, acting by and through its Mayor and City Council.

(Z) **"New Port Richey's Water Service Area"** shall mean the geographic boundaries within which New Port Richey is permitted and authorized to provide Water Service.

(AA) **"Obligations"** shall mean the Series 1998 Bonds and any other series of bonds or other evidence of indebtedness, including, but not limited to, notes, commercial paper, capital leases or any other obligations of the Authority heretofore or hereafter issued or incurred.

(BB) **"Operating Reserve Funds"** shall mean those funds which are deemed by the Authority as necessary to meet any cash flow and revenue collection shortfalls due to

inaccuracies in the Annual Reports or Annual Estimates or due to the requirements of the Financing Documents. The amount of Operating Reserve Funds shall be established by Authority policy; provided such amount shall not exceed an amount equal to two times the monthly average Variable Costs as provided in the Authority's preliminary budget.

(CC) "**Operation, Maintenance and Administrative Costs**" shall mean any and all costs incurred by the Authority in operating, maintaining and administering the System, including, but not limited to, the general administrative and legal costs of the Authority related to operation, maintenance, management, security and development of the System; costs associated with tools, equipment, vehicles, supplies, materials, services and support for the operation, maintenance, management, security and development of the System; any costs of litigation or a legal judgment against the Authority; costs relating to Water conservation and public education activities; costs of purchasing any Water; development expenses relating to expansion of the System; all costs incurred in planning or applying for, obtaining, maintaining and defending Environmental Permits which shall not be paid from the Capital Improvement Charge; accounting, legal and engineering expenses; ordinary and current rentals of equipment or other property; refunds of moneys lawfully due to others; pension, retirement, health and hospitalization funds; payments in lieu of taxes and facility impact fees; moneys to be deposited to a rate stabilization fund; and fees for management of the System or any portion thereof.

(DD) "**Pasco**" shall mean Pasco County, Florida, a political subdivision of the State of Florida, acting by and through its Board of County Commissioners.

(EE) **"Pasco Water Service Area"** shall mean the geographic boundaries within which Pasco is permitted and authorized to provide Water Service.

(FF) **"Pinellas"** shall mean Pinellas County, Florida, a political subdivision of the State of Florida, acting by and through its Board of County Commissioners.

(GG) **"Pinellas Water Service Area"** shall mean the geographic boundaries within which Pinellas is permitted and authorized to provide Water Service.

(HH) **"Points of Connection"** shall mean those points where the Member Governments' water utility systems connect to the Authority's System for the purpose of delivering Quality Water from the Authority's System to the Member Governments, which Points of Connection are more particularly described on Exhibit C to this Contract.

(II) **"Primary Environmental Permit"** shall have the meaning provided therefor in the Interlocal Agreement.

(JJ) **"Quality Water"** shall mean Water which (1) meets State and federal drinking water regulations and standards as defined in Rule 62-550, Florida Administrative Code, as it may be amended or superseded from time to time, including regulations pertaining to surface water or groundwater under the direct influence of surface waters, but excluding regulations pertaining to disinfection and corrosivity, and (2) would not cause a particular Member Government utility to adopt new treatment techniques beyond modified chemical dosages and/or optimization of existing unit processes to meet a moderately altered source of Water. Except as otherwise provided herein, the provisions of this definition are not intended as permission for a Member Government to reject the type of Quality Water to be provided by the Authority to such Member Government;

provided, however, the Authority shall pay for any additional treatment costs required to meet the standards for Quality Water as described herein. In addition, Quality Water shall meet the standards provided in Exhibit D attached hereto. The term "Quality Water" also includes Water delivered to the Points of Connection identified in Section 3.03(D) of the Interlocal Agreement or to Points of Connection at which a Member Government agrees, at its sole option, to accept Water not meeting the standards for Quality Water pursuant to Section 3.03(E) of the Interlocal Agreement.

(KK) "**Production Failure**" shall have the meaning provided therefor in the Interlocal Agreement.

(LL) "**Renewal and Replacement Charges**" shall mean those certain charges to be deposited to any renewal and replacement fund or account established pursuant to the Financing Documents.

(MM) "**Series 1998 Bonds**" shall mean the Authority's Utility Revenue Bonds, Series 1998. The Series 1998 Bonds may be issued in more than one series.

(NN) "**St. Petersburg**" shall mean the City of St. Petersburg, Florida, a municipal corporation of the State of Florida, acting by and through its Mayor and City Council.

(OO) "**St. Petersburg Water Service Area**" shall mean the geographic boundaries within which St. Petersburg is permitted and authorized to provide Water Service.

(PP) "**State**" shall mean the State of Florida.

(QQ) "**SWFWMD**" shall mean the Southwest Florida Water Management District, an agency of the State of Florida, created pursuant to Chapter 373, Florida Statutes, or any successor agency.

(RR) "**Tampa**" shall mean the City of Tampa, Florida, a municipal corporation of the State of Florida, acting by and through its Mayor and City Council.

(SS) "**Tampa Water Service Area**" shall mean the geographic boundaries within which Tampa is permitted and authorized to provide Water Service.

(TT) "**Transferred Assets**" shall mean the Water Supply Facilities (including real property, tangible personal property and intangible personal property) conveyed to the Authority pursuant to Sections 5.01, 5.02, 5.03, 5.04, 5.05 and 5.06 of the Interlocal Agreement; provided, however, that any equity interest of the Member Governments in the Existing Authority System that is relinquished pursuant to Sections 5.01, 5.02, 5.03, 5.04, 5.05 and 5.06 of the Interlocal Agreement shall not constitute a "Transferred Asset."

(UU) "**Variable Costs**" shall mean all costs and expenses of the Authority for the operation, maintenance and management of the System that change in direct proportion to changes in the volume of Water produced by the Authority, including, but not limited to, power, chemical and Water purchases.

(VV) "**Water**" shall mean Quality Water and any other water to be used by a Member Government in its public water supply system.

(WW) "**Water Service**" shall mean the provision of Water as required in the Interlocal Agreement to any and all of the Member Governments at the locations described

in Exhibit C attached hereto and provision of Water by the Member Governments to their customers.

(XX) **"Water Service Areas"** shall mean, collectively, the Hillsborough Water Service Area, the New Port Richey Water Service Area, the Pasco Water Service Area, the Pinellas Water Service Area, the St. Petersburg Water Service Area and the Tampa Water Service Area. The Water Service Areas are described in Exhibit E attached hereto, as the same may be amended or supplemented from time to time pursuant to the terms hereof.

(YY) **"Water Supply Facilities"** shall mean Water production, treatment and transmission facilities. The term "Water Supply Facilities" does not include facilities for local distribution.

SECTION 4. TERM. The term of this Contract shall begin on the Effective Date and shall end on the later of (A) the date the Interlocal Agreement is terminated in accordance with the provisions thereof, or (B) the date on which no Obligations shall remain outstanding pursuant to the Financing Documents.

SECTION 5. CONDITIONS PRECEDENT. This Contract shall become effective upon satisfaction of the following conditions precedent:

(A) Execution of Contract. This Contract shall be duly authorized, executed and delivered by the Authority, Hillsborough, New Port Richey, Pasco, Pinellas, St. Petersburg and Tampa.

(B) Series 1998 Bonds. The Authority shall have issued the Series 1998 Bonds.

(C) The Transferred Assets. The Transferred Assets shall have been conveyed to the Authority as provided in the Interlocal Agreement.

(D) Interlocal Agreement. All conditions described in Sections 6.03(A) and (D) of the Interlocal Agreement shall have been satisfied or waived in writing by the Member Governments.

(E) Certification of Representations. Each of the parties hereto shall certify that the representations described in Section 7 hereof are true and accurate in all material respects as of the Effective Date.

SECTION 6. SATISFACTION OF THE CONDITIONS PRECEDENT. The Authority and each Member Government shall provide a written statement acknowledging the satisfaction of conditions of Section 5 hereof; provided, however, no Member Government shall be required to acknowledge satisfaction of any condition of which such Member Government has no knowledge. Receipt of such statements shall be conclusive evidence of the satisfaction of such conditions. All conditions precedent must be satisfied by the Full Implementation Date, otherwise all provisions hereof shall be void ab initio.

SECTION 7. REPRESENTATIONS OF THE PARTIES. As of the Effective Date, the Authority, Hillsborough, New Port Richey, Pasco, Pinellas, St. Petersburg and Tampa each make the following representations as it relates to itself (no representation is made by any party for any other party):

(A) Status of the Parties. The Authority, Hillsborough, New Port Richey, Pasco, Pinellas, St. Petersburg and Tampa are each duly organized, validly existing and in good

standing under the laws of the State and are each duly qualified and authorized to satisfy their responsibilities pursuant to this Contract.

(B) Authority to Enter the Contract. The Authority, Hillsborough, New Port Richey, Pasco, Pinellas, St. Petersburg and Tampa each have the power, authority and legal right to enter into and perform the obligations set forth in this Contract, and the execution, delivery and performance hereof by the Authority, Hillsborough, New Port Richey, Pasco, Pinellas, St. Petersburg and Tampa: (i) has been duly authorized by the Board of Directors in the case of the Authority, by the Board of County Commissioners in the case of Hillsborough, Pasco and Pinellas, by the Mayor and City Council in the case of New Port Richey and Tampa and by the City Council in the case of St. Petersburg; (ii) does not require any consent or referendum of the voters; and (iii) does not constitute a default under, or result in the creation of any lien, charge, encumbrance or security interest upon, the assets of the Authority or any of the Member Governments under any agreement or instrument to which the Authority or any of the Member Governments is a party or by which the Authority or any of the Member Governments and their assets may be bound or affected, except as otherwise provided herein.

(C) Validity of the Contract. This Contract has been duly entered into and delivered by the Board of the Directors in the case of the Authority, the Board of County Commissioners in the case of Pasco, Hillsborough and Pinellas, by the City Council and Mayor in the case of New Port Richey, St. Petersburg and Tampa and, as of the Effective Date, constitutes a legal, valid and binding obligation of the Authority and the Member Governments, fully enforceable in accordance with its terms, except to the extent that the

enforceability of this Contract may be limited by any applicable bankruptcy, moratorium, reorganization or other similar laws affecting creditor's rights generally, or by the exercise of judicial discretion in accordance with general principles of equity.

(D) Pending Litigation. Other than matters previously disclosed in writing to the parties hereto, there is no action, suit or proceeding, at law or in equity, before or by any court or governmental authority, pending against the Authority or any of the Member Governments, wherein any unfavorable decision, ruling or finding would materially and adversely affect the performance by the Authority or any of the Member Governments of their obligations hereunder or the other transactions contemplated hereby, or which, in any way, would adversely affect the validity or enforceability of this Contract, or any other agreement or instrument entered into by the Authority in connection with the transactions contemplated hereby.

SECTION 8. AUTHORITY'S AGREEMENT TO PROVIDE WATER SERVICE. (A) Provision of Water Service. The Authority shall sell and deliver sufficient Quality Water to the Member Governments to meet their need for Quality Water and the Member Governments shall purchase and receive the Quality Water delivered by the Authority to meet their needs in accordance with the terms of this Contract; subject, however, to the representations, conditions, limitations and restrictions set forth in this Contract and the Interlocal Agreement. Except as provided in the Interlocal Agreement, Water Service obtained by the Member Governments from the Authority may be utilized to serve only the Member Governments or their customers within their respective Water Service Areas. Nothing herein shall be construed to prohibit the Member Governments

from temporarily exchanging or purchasing Water, either among themselves or with other public or private utilities, for emergency or maintenance purposes in the ordinary course of business.

(B) Insufficient Water. The Authority shall be in default hereunder should it fail to provide to each Member Government a supply of Quality Water sufficient to meet its needs, except where the Authority's failure to supply the Quality Water needs of each Member Government is due to force majeure, as described in Section 21(E) hereof. In the event that there is, at any time, an insufficient supply of Quality Water available to fulfill the needs of the Member Governments due to force majeure described in Section 21(E) hereof, the Authority shall not be in default hereunder, if, in such circumstances, it shall furnish and deliver to the Member Governments, their pro rata share (or a share that as closely approximates their pro rata share as is reasonably practicable in the circumstances) of available supply, unless otherwise required by law, court order, or appropriate regulatory authorities. Each Member Government's pro rata share shall be based on the average of the actual amount of Quality Water supplied each month by the Authority to such Member Government over the previous twelve (12) month period. The Authority shall use its best efforts to prevent an insufficiency of Quality Water and to remedy any such insufficiency and shall take all necessary actions to supply the Quality Water needs of each Member Government in accordance with the terms of the Interlocal Agreement.

(C) Water Use Restrictions. In the event of an insufficiency in the supply of Quality Water described in the preceding paragraph, the Authority may request the

Member Governments to implement water use restrictions which shall be applied on a uniform basis among all Member Governments. In the event a Member Government does not implement such a request within thirty (30) days of the request and the insufficiency in available Quality Water is still present, the Member Governments agree to implement water use restrictions upon request of the Authority. The purposes of such restrictions shall be to reduce demand for Quality Water among Member Governments and to ensure that a particular Member Government or Governments does not unduly suffer as a result of such insufficiency.

(D) Member Government's Rights During Production Failure. Nothing in this Section 8 shall affect a Member Government's rights under Section 3.17 of the Interlocal Agreement in the event of a Production Failure.

SECTION 9. MEMBER GOVERNMENTS' WATER SERVICE. Except as otherwise provided herein or in the Interlocal Agreement, all Water required to service the customers within the respective Water Service Areas shall be supplied by the Authority. Nothing herein shall be construed to prohibit the Member Governments from temporarily exchanging or purchasing Water, either among themselves or with other public or private utilities, for emergency or maintenance purposes in the ordinary course of business. A Member Government shall notify the Authority in writing of any change in its Water Service Area. Authority approval of a change in a Member Government's Water Service Area is not required except if such change involves providing Water outside its boundaries in the case of a Member Government which is a county or the boundaries of the county where the Member Government is located in the case of a Member Government which is a

municipality. The parties hereto agree that Pasco may provide Water Service in Hillsborough to customers in the Wyndham Lakes Subdivision.

SECTION 10. POINTS OF CONNECTION AND METER LOCATIONS. (A)

Points of Connection. The Points of Connection and the location of the Metering Facilities (which shall include master meters) that will be used to connect the Member Governments' water utility systems and the Authority's System, for Quality Water, shall be as provided in Exhibit C hereto. Each Member Government may have more than one Point of Connection with the Authority's System. Any change in the Points of Connection for a Member Government shall be incorporated by reference in Exhibit C hereto. The parties may, by mutual written agreement, more specifically identify or modify said Points of Connection or the location of the Metering Facilities, and any such additional legal description or modifications shall be considered to be a part of this Contract, as if initially set forth herein. After thirty (30) days written notice to the Authority, and with the Authority's prior written approval, not to be unreasonably withheld, delayed or conditioned, the Member Governments may, at any time, at their sole cost and expense, relocate or modify the location of the Points of Connection, as long as said relocation does not unreasonably interrupt, impair or interfere with the ability of the Authority to provide Water Service to the respective Water Service Area or service to other customers of the Authority. At the request and expense of a Member Government, the Authority may relocate or modify the location of a Point of Connection. In the event the Authority on its own initiative desires to modify a Point of Connection for a Member Government, it must

receive the approval of such Member Government, which approval shall not be unreasonably withheld, and it must pay the expenses of such modification.

(B) Conveyance of Easements. It shall be the duty of the Authority to install, operate and maintain any required Metering Facilities at the Points of Connection, as set forth in Section 11 hereof. The Member Governments shall convey to the Authority, as and when the Authority requests, at no cost and expense to the Authority, an appropriate non-exclusive easement over, under or above such portions of the Water Service Areas as may be reasonably requested by the Authority for the installation, operation and maintenance of such Metering Facilities at the Points of Connection. Such grants of non-exclusive easements shall be adequate to meet the Authority's needs but need not be more than the minimum required, according to generally accepted engineering standards, in order to perform the functions requiring said non-exclusive easements. No other easement granted by the respective Member Government over, under or above such portions of the Water Service Areas shall unreasonably interfere with the ability of the Authority to duly and properly install, operate or maintain the Points of Connection and Metering Facilities. The Authority shall acquire any property it requires for easements at the metering location and Points of Connection if not already owned by a Member Government.

(C) Pumping Stations. If a booster pump station is required to meet pressure described in Exhibit C hereto at a Point of Connection, the booster pump station shall be constructed, owned and operated by the Authority or, in the alternative at the option of the Authority, a Member Government may construct, own and operate such booster pumping

station, provided a credit shall be issued to such Member Government reflecting the Authority's avoided cost or the Member's actual cost, whichever is less. The Member Governments agree to provide available sites for future pump stations to the Authority at fair market value so that the Authority can carry out its obligations to provide adequate pressure to all Member Governments.

SECTION 11. METERING FACILITIES. (A) Installation of Metering Facilities.

The Authority shall acquire and install such Metering Facilities as are adequate in view of the Member Governments' right to receive Water Service and as will accurately measure the volume of Quality Water delivered to Member Governments by the Authority. The Authority shall retain ownership of the Metering Facilities, together with any appurtenances thereto. The type of Metering Facilities selected shall be at the discretion of the Authority, subject to compliance with industry standards for similar Metering Facilities.

(B) Inspection of Metering Facilities. Visual inspection and routine maintenance of the Metering Facilities and appurtenances thereto shall be performed annually by the Authority, and the Authority shall prepare or shall have prepared an Inspection Report regarding the condition, accuracy and state of the Metering Facilities. The Inspection Report shall be prepared at the Authority's expense by a representative of the manufacturer of the Metering Facilities or a third-party reasonably acceptable to the Authority and the Member Governments, and a copy of each such Inspection Report shall be furnished to the Member Governments. The Authority shall perform or have performed

annually at its expense a certified calibration test of the Metering Facilities and submit the results thereof to the Member Governments.

Upon request and at the expense of a Member Government, the Authority shall make arrangements for a meter test to be conducted by an independent testing facility.

The Authority shall be responsible for negotiating and paying to the independent meter testing facility any fees charged for such a test. Such independent meter testing facilities shall conform to the manufacturer's standards. Where appropriate, the meter may be field tested. The Member Governments shall have the right to observe any field test, and the Authority shall provide the Member Governments with a written report of the results of each such test.

(C) Inaccurate Meters. The Authority shall employ water meters that register within the accuracy limits provided by the manufacturer. Should the accuracy of any of the Metering Facilities be determined to be inaccurate beyond limits prescribed in applicable Environmental Permits, such Metering Facilities will be assumed to have been inaccurate since the last annual Inspection Report, calibration or the last field test or for a period of six (6) months, whichever is less, and the following month's billing will be adjusted taking into account the nature of the inaccuracy to show a credit or additional charge to the respective Member Governments for metered flow for that period. Inaccuracies which are not beyond the limits prescribed in applicable Environmental Permits shall not be credited or charged to the affected Member Governments.

SECTION 12. ANNUAL REPORT. Commencing on the Effective Date hereof and by February 1 of each year thereafter, each Member Government shall supply the

Authority with an updated Annual Report, in the form provided in Exhibit K attached hereto, setting forth the next five (5) Fiscal Years of projected Water Service demand within their respective Water Service Areas. Such projected Water Service demand shall state its projected average day and maximum day Water Service requirements. The Annual Report shall include a Long Term Forecast. The Long Term Forecast shall set forth the next twenty (20) Fiscal Years of projected Water Service demand within the respective Water Service Areas. At the Authority's request, such Member Government shall furnish to the Authority its back-up and supporting information, data and projections that form the basis of any Annual Report or Long Term Forecast. The Annual Reports shall be utilized by the Authority in formulating its capital improvement program; provided the Authority agrees that such Annual Reports are only one factor in formulating its capital improvement program and it further agrees not to rely exclusively on such Annual Reports in its determination of the Quality Water needs of the Member Governments.

SECTION 13. RATE. (A) Authority's Annual Estimate. No later than April 15 of each year during the term of this Contract, the Authority shall submit to the Member Governments the Annual Estimate which shall set forth the anticipated cost to the Authority of providing Water Service to the Member Governments for the forthcoming Fiscal Year. The Annual Estimate shall be based upon the Authority's proposed budget for such Fiscal Year. The Annual Estimate shall describe the Fixed Costs and Variable Costs of the Authority. The Annual Estimate may be revised from time to time to reflect changes to the Authority's budget. The Authority's budget shall be approved as provided in the Interlocal Agreement.

(B) Rate. The rate in effect each Fiscal Year shall be sufficient to pay the Annual Estimate established by the Authority. During the term of this Contract, the Member Governments irrevocably agree to pay to the Authority, as compensation for the Water Service received by such Member Governments, a monthly charge for such Water Service based on the rate approved by the Authority and total volume of Quality Water delivered to such Member Governments by the Authority. In addition, the Authority's rate structure may provide for debits and credits for different levels of treatment of Quality Water required of the Authority or a Member Government as described in Section 3.04 of the Interlocal Agreement. The Authority shall also provide for credits to those Member Governments who do not elect to take cash, in whole or in part, for the sale of their Transferred Assets to the Authority as provided in the Interlocal Agreement. The Authority and the Member Governments agree that the rate for Water delivered to Tampa from the Tampa Bypass Canal shall be established pursuant to the provisions of Section 3.08(D) of the Interlocal Agreement. The Member Governments shall be billed on a monthly basis in accordance with bills rendered by the Authority to each Member Government. The monthly bills delivered by the Authority to the Member Governments shall consist of two components. The first component shall be a charge for the Fixed Costs of the Authority. Each Member Government shall pay monthly an amount equal to one-twelfth of the Fixed Costs provided in the Annual Estimate times $\frac{A}{B}$, whereby A equals the amount of Quality Water delivered to such Member Government during the previous Fiscal Year and B equals the total amount of Quality Water delivered to all of the Member Governments during such Fiscal Year. The amount of Fixed Costs payable by the Member Governments

shall be subject to a true-up pursuant to Section 13(E) hereof. The second component of each monthly bill shall be the charge for the Variable Costs. Each Member Government shall pay an amount equal to the amount of Quality Water consumed by the Member Government during the prior month times the rate then in effect times $\frac{C}{D}$, whereby C equals the Variable Costs and D equals the Annual Estimate then in effect. All bills shall become due within thirty (30) days of receipt thereof by a Member Government.

(C) Rate Setting. The initial rate for Water Service to be charged by the Authority to the Member Governments is contained in Exhibit F to this Contract. Between April 15 and August 1 of each Fiscal Year, the Authority may prepare and approve an adjustment to the Water Service rate then in effect, if appropriate, based on the Authority's Annual Estimate of providing Water Service to the Member Governments during such period during which the adjustment will be in effect. Any rate adjustment put into effect as part of the Authority's budget process described above shall become effective no earlier than the next succeeding October 1. The Authority may also prepare and approve an adjustment to the rate at such other time or times as shall be required by the Financing Documents.

The rate to be charged in a Fiscal Year to the Member Governments for Water Service may include the following components:

- (i) Operation, Maintenance and Administrative Costs. Operation, Maintenance and Administrative Costs shall be based on the cost of service provided by the Authority in such Fiscal Year.

(ii) Debt Service Charges. Debt Service Charges relating to any Authority's Obligations shall be based upon the payment of, redemption premium, if any, and interest coming due on the Obligations in such Fiscal Year.

(iii) Renewal and Replacement Charges. Renewal and Replacement Charges shall be based on an engineering estimate by the Authority's consulting engineer of amounts to be deposited into the renewal and replacement fund or account at a level sufficient to satisfy in such Fiscal Year all requirements of covenants given or undertaken by the Authority in the Financing Documents.

(iv) Bond Coverage Costs. Bond Coverage Costs shall be based upon coverage requirements established by the Financing Documents.

(v) Capital Improvement Charges. Capital Improvement Charges shall be based upon the amount identified therefor in the Authority's Annual Estimate for such Fiscal Year.

(vi) Operating Reserve Funds. Operating Reserve Funds shall be based upon the amount identified therefor in the Authority's Annual Estimate for such Fiscal Year.

The Member Governments agree that the Authority may establish a rate stabilization fund. Operation, Maintenance and Administrative Costs and/or Operating Reserve Funds may be utilized by the Authority to fund such rate stabilization fund.

(D) Procedure for Rate Adjustments. Prior to the adoption of any proposed new or adjusted rate, the Authority shall provide to the Member Governments its proposed rate, with supporting data and calculations. Any disagreements in the proposed rate shall be

submitted for determination in the manner and mode set forth in Section 19 hereof. Notwithstanding any disagreement by any such Member Government of the proposed rate, the Authority may, nonetheless, implement said proposed rate at any time not less than sixty (60) days after receipt thereof by the Member Governments. Upon completion of the determination regarding the propriety of the proposed rate, pursuant to the procedures set forth in Section 19 hereof, the rate so determined to be proper shall become the adopted and approved adjusted rate. If the proposed rate is determined to have been in excess of the rate permitted under this Contract, in whole or in part, then the Authority shall, within thirty (30) days of said determination, refund to such Member Government the difference between the proposed rate collected by the Authority and the rate found to be proper pursuant to the determination made under Section 19 hereof.

A copy of the Authority's rate, as it may be adjusted or proposed from time to time, is intended to be incorporated herein by this reference, and shall be considered to be attached hereto as Exhibit F.

(E) Annual True-Up. Following the end of each Fiscal Year, an annual adjustment in the Fixed Costs component of bills paid during that Fiscal Year shall be computed on the basis of (i) the Fixed Costs which are provided in the Annual Estimate in effect during the Fiscal Year then ended and (ii) the actual amount of Quality Water delivered to each of the Member Governments during the Fiscal Year then ended. The Authority shall determine the amount of Fixed Costs payable by each Member based upon actual delivery of Quality Water during the previous Fiscal Year. Such determination shall be made within forty-five (45) days of the end of the Fiscal Year. In the event the determination reflects

that an underpayment has been made by a Member Government as a result of consumption of an increased amount of Water by such Member Government, then the full amount due and owing for said underpayment shall be paid by the Member Government to the Authority within sixty (60) days of the Member Government's receipt of the determination. In the event the determination reflects that an overpayment has been made by a Member Government as a result of consumption of a lesser amount of Quality Water by such Member Government, then the amount of said overpayment shall be paid to the Member Government within sixty (60) days following distribution of the determination. Neither underpayments nor overpayments shall bear interest. Each such adjustment in payments shall be verified by the Authority's annual audit. The annual audit shall be distributed to the Member Governments on or before March 1 of the year following the end of each Fiscal Year. The Authority shall adjust any overpayments or underpayments to reflect the Quality Water consumption amounts provided in the annual audit.

(F) Carry-Forward. Any unencumbered moneys of the Authority present at the end of a Fiscal Year shall be budgeted by the Authority for the succeeding Fiscal Year and shall be utilized for the same purposes for which rates are charged by the Authority to the Member Governments pursuant to this Section 13.

SECTION 14. PLEDGE OF CONTRACT REVENUES. The Authority is hereby authorized to pledge all payments due, owing or received by Member Governments pursuant to the terms hereof, any interest or other income derived from moneys received under this Contract and any other moneys of the Authority for the purpose of securing the Obligations issued by the Authority.

SECTION 15. DEVELOPMENT OF NEW WATER SUPPLY SOURCES.

Unless prevented by force majeure, as described in Section 21(E) hereof, the Authority will develop new Water Supply Facilities as provided in the Interlocal Agreement in order to meet the Quality Water supply needs of the Member Governments. The Authority and the Member Governments realize that the development of new water supply sources and the implementation of the Master Water Plan are paramount to the Authority's ability to fulfill its Water Service obligations under this Contract, and the parties hereby agree to work together toward accomplishing the objectives set forth in the Master Water Plan and the Interlocal Agreement.

SECTION 16. MEMBER GOVERNMENTS' RIGHTS TO DEVELOP AND SUPPLY WATER. Member Governments may develop Water Supply Facilities or purchase Water from persons other than the Authority only to the extent provided in the Interlocal Agreement.

SECTION 17. ADDITIONAL REPRESENTATIONS, WARRANTIES AND COVENANTS OF THE AUTHORITY. The Authority hereby represents, warrants and covenants to the Member Governments as follows:

(A) Water Quality. The Authority shall deliver to the Member Governments Quality Water from the Authority's System at the Points of Connection. Upon the request, and at the expense, of a Member Government and upon the conditions described in Section 3.04 of the Interlocal Agreement, the Authority may provide additional treatment to the Quality Water.

(B) Environmental Permits. The Authority shall obtain, renew, maintain and modify, if necessary, all Environmental Permits necessary to provide Water Service to the Water Service Areas in accordance with the terms of the Interlocal Agreement. The Authority further agrees to comply with all Environmental Permit conditions and applicable rules and regulations.

(C) Financing Water Supply Facilities. The Authority shall from time to time issue such Obligations as it deems necessary to cover the costs incurred in constructing, acquiring, operating, replacing and expanding the Authority's System; provided any Obligations issued to finance operating expenses shall mature no later than one year from the date of their issuance.

(D) Accounting. The Authority shall maintain accounts and records for all funds received and disbursed by it with respect to Water Service. On or before each March 1, beginning on the March 1 immediately following the date upon which all conditions precedent in Section 5 hereof are satisfied, the Authority shall complete an audit of the aforesaid accounts. Said audit shall be conducted by a nationally recognized certified public accounting firm.

(E) Adequate Water and Environmental Effects. The Authority shall supply Water Service to the Member Governments and reduce adverse environmental effects of excessive or improper withdrawals of Water from concentrated areas as provided herein and in the Interlocal Agreement.

(F) Conservation. The Member Governments shall have primary responsibility for implementing means, methods and techniques relating to Water conservation;

provided, however, the Authority may continue to plan and coordinate the conservation efforts of the Member Governments.

(G) Operation of System. The Authority shall at all times operate and maintain the System in accordance with prudent utility practices.

(H) Compliance with Laws. The Authority shall comply with all laws, rules and regulations applicable to this Contract and its obligations arising hereunder.

(I) Equitable Treatment of Member Governments. The Authority shall treat all Member Governments equitably without preference for any one Member Government over another Member Government, all in accordance with the terms of this Contract and the Interlocal Agreement.

(J) Rate. The rate charged by the Authority to the Member Governments for Water Service shall be reasonable.

SECTION 18. ADDITIONAL REPRESENTATIONS, WARRANTIES AND COVENANTS OF THE MEMBER GOVERNMENTS. The Member Governments hereby represent, warrant and covenant to the Authority as follows:

(A) Irrevocable Commitment to Pay. The Member Governments shall pay their respective monthly bills for Water Service to their respective Water Service Areas for every Fiscal Year throughout the term of this Contract in the manner provided in Section 13 hereof. Said payments by the parties shall be made without notice or demand and without set-off, counterclaim, abatement, suspension or deduction. The Authority is undertaking the acquisition, construction, operation, replacement and expansion of the

Authority's System on the representations, warranties and covenants of the Member Governments set forth in this Section 18.

(B) Acquisition of Real Property. The Member Governments shall cooperate with the Authority in acquiring all interests in real property necessary to acquire, construct, manage, operate and expand the Authority's System.

(C) Member Governments' Water Utility System Charges. The Member Governments shall fix, revise, maintain and collect such fees, rates, tariffs, rentals, or other charges for the use of products, services and facilities of their respective Member Government's water utility systems to the extent necessary to fund the timely payment of their respective obligations and liabilities under this Contract.

(D) Member Governments' Water Utility System Operation and Maintenance Account. Except as otherwise provided herein, the Member Governments shall maintain their Member Governments' water utility system operation and maintenance accounts throughout the term of this Contract for the purpose of paying their obligations and liabilities under this Contract. At all times during the term of this Contract, the parties' obligations and liabilities under this Contract shall be considered an operating expense of their water utility systems and shall be paid from their water utility systems operation and maintenance accounts; provided, however, that such obligations and liabilities of a Member Government shall not be considered an operating expense of its water utility system nor need it be paid from the operation and maintenance account to the extent the Member Government has budgeted and appropriated legally available moneys for such purpose and is current on all its obligations arising hereunder.

(E) Member Government Payment Obligation. A Member Government shall not be liable under this Contract for the obligations of any other Member Government. A Member Government shall be solely responsible and liable for performance of its obligations under this Contract. The obligation of a Member Government to make payments under this Contract is a severable obligation and not a joint obligation with the other Member Governments.

(F) Cooperation on Issuance of Authority Obligations. Each Member Government shall cooperate with the Authority in issuance of the Authority's Obligations. In such connection, each Member Government and the Authority shall comply with reasonable requests of each other and will, upon request, do as follows: (i) make available general and financial information about itself; (ii) consent to publication and distribution of its financial information; (iii) certify that its general and financial information is accurate, does not contain any untrue statements of a material fact and does not omit to state a material fact necessary to make the statements in the information, in light of circumstances under which they are made, not misleading; (iv) make available certified copies of official proceedings; (v) provide reasonable certifications to be used in a transcript of closing documents; and (vi) provide and pay for reasonable requested opinions of counsel as to the validity of its actions taken in respect to and the binding effect of the Interlocal Agreement and this Contract, title to its Water supply system, as applicable, and pending litigation which could materially affect its performance hereunder. In addition, each Member Government agrees to take no action which shall adversely affect the exclusion from gross income of interest on the Authority's Obligations for

purposes of federal income taxation. Each Member Government shall provide the Authority reasonable assurance that no actions taken by it shall adversely affect the exclusion from gross income of interest on the Authority's Obligations for purposes of federal income taxation. Each Member Government further agrees that it shall pay any arbitrage rebate liability arising pursuant to Section 148 of the Internal Revenue Code of 1986, as amended, from the use or investment of proceeds of the Series 1998 Bonds which are paid to such Member Government for acquisition of its Transferred Assets by the Authority.

SECTION 19. ARBITRATION. (A) Arbitration. Except as otherwise provided in this Section 19, any disputes respecting monetary defaults committed by the Authority or any of the Member Governments, any disputes regarding Water quality as provided in Exhibit D hereto, and any disputes between the Authority and any Member Government involving fiscal matters arising under this Contract, which are not otherwise resolved after due diligent effort by the parties, shall be resolved through binding arbitration in accordance with the following provisions of this Section 19. Such binding arbitration shall be the sole and exclusive method of resolving disputes described above.

(i) Arbitration shall be commenced by one party serving written notice upon on the other parties of its demand to arbitrate. Within sixty (60) days after actual receipt of a written demand to arbitrate, the parties shall proceed with arbitration. Within said sixty (60) days, the Authority and the Member Government each shall appoint a person as arbitrator. Each appointment shall be signified in writing by each party to the other, and the arbitrators so appointed shall, within ten

(10) days of their appointment, appoint a third arbitrator and who shall chair the panel. If the arbitrators appointed by the parties are unable to agree upon a third arbitrator, the third arbitrator shall be appointed by the American Arbitration Association from its qualified panel of arbitrators. If the Authority or the Member Government fails to appoint an arbitrator within sixty (60) days after receipt from the other party of a written demand to arbitrate, then the arbitrator appointed by the party not in default hereunder shall appoint a second arbitrator and the two so appointed shall appoint a third arbitrator to chair the panel. None of the arbitrators shall have a business or other pecuniary relationship with either party, except for payment of the arbitrator's fees and expenses.

(ii) In the event a dispute arises involving the Authority and more than one Member Government in regard to the same subject matter, such parties may agree to one arbitration proceeding to settle such a dispute. Within sixty (60) days of such agreement, the Authority, individually, and the Member Governments, collectively, shall each appoint a person as arbitrator. Each appointment shall be signified in writing by each party to the other parties and the arbitrators so appointed shall, within ten (10) days of their appointment, appoint a third arbitrator who shall chair the panel. If the arbitrators appointed are unable to appoint a third, such third arbitrator shall be appointed by the American Arbitration Association from its qualified panel of arbitrators. If either the Authority or the Member Governments fail to appoint an arbitrator within sixty (60) days after agreement to proceed with a single arbitration, then the arbitrator appointed shall appoint a second arbitrator

and the two so appointed shall appoint a third arbitrator to chair the panel. None of the arbitrators shall have a business or other pecuniary relationship with any of the parties, except for payment of the arbitrator's fees and expenses.

(iii) The three arbitrators, after being duly sworn to perform their duties with impartiality and fidelity, shall proceed to determine the questions submitted.

The arbitrators may, at their discretion, and shall, upon the written request of either the Authority or the Member Government(s), engage experts to provide peer review of any scientific and technical studies introduced by parties. The arbitration hearing shall convene not earlier than ninety (90) days and not later than one hundred twenty (120) days of the appointment of the chair by the arbitrators, unless the parties agree to an earlier date. The arbitrators shall render an award within sixty (60) days of the conclusion of the arbitration hearing, and such award shall be in writing and in duplicate, one counterpart thereof to be delivered simultaneously to each of the parties. The award shall contain findings of fact and conclusions of law and shall be final and binding upon the parties involved.

(iv) The fees, charges and expenses of such arbitrators and any experts engaged by the arbitrators shall be borne equally by the parties. The fees of respective counsel engaged by the parties, and the fees of expert witnesses and other witnesses called by the parties shall be paid by the respective party engaging such counsel or engaging such witnesses.

(v) Except to the extent inconsistent with this Section 19, the American Arbitration Association standards shall apply to any arbitration proceedings

conducted under the provisions of this Section 19. The venue for any such action shall be the county in which the Authority maintains its principal office. Discovery shall be conducted pursuant to the rules set forth in Exhibit L attached hereto unless all parties to the proceeding agree to modify such rules.

(B) Continuation of Payments. The Member Governments agree that during any such period of arbitration, they shall continue to promptly make all payments due to the Authority, pursuant to the terms of this Contract, and the Authority shall continue to provide Water Service to such Member Governments in accordance with the terms hereof.

(C) Exclusive Remedy. Other than as provided herein, the Authority and the Member Governments hereby establish binding arbitration, as described in this Section 19, as the sole and exclusive method of resolving the disputes arising hereunder which are subject to arbitration. It is expressly agreed that no Member Government shall fund the participation of, or provide in-kind contributions to, any third-party in an administrative or judicial review of any matter which is the subject of arbitration hereunder; provided, however, that this Section 19(C) shall not apply to the Hillsborough County Environmental Protection Commission while in compliance with the agreement between itself, the Authority and the Member Governments.

(D) Events Not Subject to Arbitration. Other than disputes regarding monetary defaults, disputes regarding Water quality as provided in Exhibit D hereto and disputes regarding fiscal matters arising under this Contract, no other disputes arising hereunder shall be subject to the mandatory arbitration provisions of this Section 19; provided the

parties hereto may avail themselves of such arbitration procedures for other disputes on a voluntary basis.

SECTION 20. AUTHORITY'S SOURCES OF WATER. Subject to any rights a Member Government may have pursuant to the Interlocal Agreement, the Authority may provide Water Service to satisfy its obligations hereunder from any component of its System or such other source deemed appropriate by the Authority and the Authority may use any component of its System or such other source to transport water to the Points of Connection.

SECTION 21. DEFAULT AND REMEDY. (A) Defaults. In the event any of the parties default under any of the terms or provisions of this Contract and such default is not subject to the provisions of Section 19 hereof, the parties may avail themselves of any rights or remedies available under applicable law. Notwithstanding the commission of an act of default by a Member Government under any of the terms or provisions of this Contract, none of the parties hereto shall be relieved from their obligations under the terms of this Contract to provide, receive or pay for timely and sufficient Water Service in accordance with the provisions of this Contract. The parties, however, shall not be assumed to have waived any such default by the continuation of the provision or payment of said Water Services. The parties hereto acknowledge that this Contract may not be terminated except as provided in Section 4 hereof.

(B) Reliance by Holders of Obligations. The parties acknowledge that to finance the acquisition and construction of improvements and expansion of the System, the Authority will issue Obligations from time to time and, by reason of such issuance by the

Authority, it is essential that the Authority be paid in a timely fashion all sums due from Member Governments pursuant to this Contract. In light of the obligations of the Authority to holders of Obligations, and the Authority's reliance on Member Governments' representation and covenant that payment of all sums due to the Authority under the terms of this Contract shall be prompt in their remittal, the parties hereby agree to resolve any disputes over the correct amount of monthly billings in accordance with Section 19 hereof. During the pendency of such dispute resolution proceedings, the Authority agrees to continue to provide Water Service to the Member Governments, and the Member Governments agree to continue to pay in full, as billed, for such service, but subject to the Authority's obligation to refund to the Member Governments any amount collected in excess of the amount ultimately determined to have been proper with interest on such excess amount from the date of payment at the rate then prevailing for investments in the Local Government Surplus Funds Trust Fund.

(C) Failure to Pay Monthly Bills. In the event that a Member Government fails to pay the full amount of a bill for monthly service or for any other amount coming due to the Authority under this Contract within thirty (30) days of receipt of said bill, then such Member Government shall pay interest on the unpaid balance from the original due date to the date of payment at the rate then prevailing for investments in the Local Government Surplus Funds Trust Fund.

(D) Bankruptcy by Member Government. In the event a Member Government becomes insolvent, or voluntary or involuntary bankruptcy proceedings are instituted against such Member Government, or a Member Government becomes unable or fails to

meet its obligations to its creditors as they come due, the Authority shall thereupon become entitled to seek the appointment of a receiver for the revenues of such Member Government's water utility system (but not for the operation of a Member Government's water utility system). In the event a receiver is appointed for the revenues of such Member Government's water utility system in accordance with this Section 21, said receiver shall, subject to orders of the appointing court, have the exclusive right to obtain, collect and deposit or invest all revenues payable to or received by a Member Government from its water customers, to pay to the Authority from such revenues all amounts due or becoming due to the Authority under this Contract, and to make payments under the provisions of resolutions or indentures pertaining to outstanding debt of a Member Government that is secured by the revenues of the water utility system.

The Authority's right to seek the appointment of a receiver under the provisions of this Section 21 shall be subordinate to any right to the appointment of a receiver that may be conferred upon the holders of debt obligations secured by the revenues of a Member Government's water utility system. By virtue of the treatment of amounts due to the Authority under this Contract as operating expenses of a Member Government (except as otherwise provided in Section 18(D) hereof), it is acknowledged that the Authority's right to receive payments hereunder will be prior to the right of the holders of the debt obligations of a Member Governments water utility system. A Member Government shall have the right to contest the appointment of a receiver only in the event that such Member Government is not in default on any payment obligations to the Authority hereunder at the time of the filing of the Authority's petition for the appointment of such a receiver. Such

Member Government shall be entitled to have the receivership discharged at any time upon demonstration to the court that the Authority is current in the payment of all amounts then due and owing to the Authority hereunder and in substantial compliance with the material covenants and agreements of the Member Government hereunder.

(E) Force Majeure. In the event that the performance of this Contract by any party is prevented or interrupted in consequence of any cause strictly beyond the control of such party including, but not limited to, Acts of God; war; national emergency; allocation or other governmental restrictions upon the use or availability of labor or materials; shortages of energy sources or supplies; failure to obtain electricity or telephone service; shortages of raw materials; rationing; civil insurrection, riot, disorder or demonstration; strike; lock out; embargo; flood; tidal wave; fire; explosion; bomb detonation; nuclear fallout; windstorm; hurricane; earthquake; a casualty, disaster or catastrophe; unforeseeable failure or breakdown of pumping, transmission, processing or other facilities; governmental rules, acts, orders, restrictions, regulations or requirements (other than denial of an Environmental Permit); discretionary acts or actions of any government, public, governmental authority, commission, board, agency, agent, official or officer (except for the acts or actions of the Authority or Member Governments or its agents or officers and affecting this Contract or the denial of an Environmental Permit); the enactment of any statute, ordinance, resolution, regulation, rule, ruling or order (other than denial of an Environmental Permit); a decree, judgment or injunction of any court; or the failure to obtain any required permit or governmental approval after making its best efforts to obtain same; said party shall not be liable for such nonperformance, but only for the

duration of or to the extent of said force majeure and only if said party is not directly or indirectly responsible therefor. Any party claiming to be relieved of any duty pursuant to this Section 21 shall give prompt written notice thereof to the other parties. The parties agree, however, to remedy with all reasonable dispatch the cause or causes preventing a party from carrying out its agreement.

SECTION 22. DISPOSITION OF ASSETS UPON TERMINATION OF AUTHORITY. Upon termination of the Authority, all assets and property of the Authority shall be disposed of as provided in Section 6.04 of the Interlocal Agreement.

SECTION 23. APPLICABLE LAW AND VENUE. The laws of the State of Florida shall govern the validity, interpretation, construction and performance of this Contract and venue for any suit involving this Contract shall be in the county where the Authority's principal office is located.

SECTION 24. ASSIGNMENT. No assignment, delegation, transfer or novation of this Contract or any part hereof shall be made unless approved in writing by all parties.

SECTION 25. NOTICES. All notices, demands, requests and other communications hereunder shall be deemed sufficient and properly given, if in writing and delivered in person to the following addresses or sent by certified or registered mail, postage prepaid with return receipt requested, at such addresses; provided, if such notices, demands, requests or other communications are sent by mail, they shall be deemed as given on the third day following such mailing which is not a Saturday, Sunday or a day on which United States mail is not delivered:

If to the Authority: West Coast Regional Water Supply Authority
2535 Landmark Drive, Suite 211
Clearwater, Florida 33761
Attention: General Manager

If to Pinellas: Board of County Commissioners
315 Court Street
Clearwater, Florida 34616
Attention: County Administrator

If to Pasco: Board of County Commissioners
7530 Little Road, Room 340
West Pasco Government Center
New Port Richey, Florida 34654
Attention: County Administrator

If to Hillsborough: Board of County Commissioners
601 East Kennedy Boulevard, 26th Floor
Tampa, Florida 33602
Attention: County Administrator

If to St. Petersburg: City of St. Petersburg
One Fourth Street North
St. Petersburg, Florida 33701
Attention: City Administrator

If to Tampa: City of Tampa
315 East Kennedy Boulevard
Tampa, Florida 33602
Attention: Mayor

If to New Port Richey: City of New Port Richey
5919 Main Street
New Port Richey, Florida 34652
Attention: City Manager

Any party may, by like notice, designate any further or different addresses to which subsequent notices shall be sent. Any notices hereunder signed on behalf of the notifying party by a duly authorized attorney at law shall be valid and effective to the same extent as if signed on behalf of such party by a duly authorized officer or employee.

SECTION 26. THIRD-PARTY BENEFICIARIES. The Authority, St. Petersburg, Tampa, New Port Richey, Pasco, Pinellas and Hillsborough agree the holders of any Obligations issued by the Authority to finance or refinance the acquisition, construction, improvement, replacement or operation of the Authority's System shall be third-party beneficiaries of this Contract and the rights, obligations, representations and warranties of the Authority, Hillsborough, New Port Richey, Pasco, Pinellas, St. Petersburg and Tampa pursuant to this Contract and the Interlocal Agreement. No right or cause of action shall accrue upon or by reason hereof, or for the benefit of any other person not expressly named as a party in this Contract.

SECTION 27. WAIVER. Unless otherwise specifically provided by the terms of this Contract, no delay or failure to exercise a right resulting from any breach of this Contract shall impair such right or shall be construed to be a waiver thereof, but such right may be exercised from time to time and as often as may be deemed expedient. Any waiver shall be in writing and signed by the party granting such waiver. If any representation, warranty or covenant contained in this Contract is breached by any party and thereafter waived by another party, such waiver shall be limited to the particular breach so waived and shall not be deemed to waive, either expressly or impliedly, any other breach under this Contract.

SECTION 28. CAPTIONS AND REFERENCES. The title page, table of contents, section headings and captions contained herein are included for convenience of reference only and shall not be considered part of this Contract or affect in any manner

its construction or interpretation. Except as otherwise indicated, all references herein to sections are to sections of this Contract.

SECTION 29. SEVERABILITY. In the event that any provision of this Contract shall, for any reason, be determined invalid, illegal or unenforceable in any respect, the parties hereto shall negotiate in good faith and agree to such amendments, modifications or supplements of this Contract or such other appropriate actions as shall, to the maximum extent practicable in light of such determination, implement and give effect to the intentions of the parties as reflected herein, and the other provisions of this Contract, as amended, modified, supplemented or otherwise affected by such action, shall remain in full force and effect.

SECTION 30. AMENDMENT. This Contract may only be amended by a written document duly executed by the Authority, Hillsborough, New Port Richey, Pasco, Pinellas, St. Petersburg and Tampa. The parties hereto agree to make no amendment hereto or to the Interlocal Agreement which will materially adversely affect the rights or security of the holders of the Obligations.

SECTION 31. NO OTHER AGREEMENTS. This Contract shall constitute the entire agreement of the Authority, Hillsborough, New Port Richey, Pasco, Pinellas, St. Petersburg and Tampa with respect to the matters provided herein.

SECTION 32. EXISTING AGREEMENTS. The agreements for the supply of water by the Authority to a Member Government described in Exhibit G hereto shall be terminated and shall no longer be in effect upon the Effective Date hereof. The agreements described in Exhibit H hereto shall remain in full force and effect. The parties

hereto agree to modify the agreements described in Exhibit I as specified therein and further agree that the agreements described in Exhibit I shall be superseded to the extent they are not expressly modified. The agreements described in Exhibit J hereto shall be superseded to the extent of any conflict or inconsistency with the Interlocal Agreement or this Contract. Any other agreement of the Authority or Member Government relating to Water production, transmission, treatment, delivery or sale not specifically described in Exhibit G, H, I or J shall be superseded by the Interlocal Agreement and this Contract to the extent of any conflict or inconsistency with such Agreement or this Contract.

SECTION 33. SUCCESSORS AND ASSIGNS. This Contract shall be binding upon and inure to the benefit of the respective successors, permitted assigns, administrators and trustees of the Authority, Hillsborough, New Port Richey, Pasco, Pinellas, St. Petersburg and Tampa.

SECTION 34. EXECUTION OF DOCUMENTS. This Contract shall be executed in multiple duplicate originals, any of which shall be regarded for all purposes as an original and all of which shall constitute one and the same instrument.

SECTION 35. INTERLOCAL AGREEMENT. This Contract shall constitute an interlocal agreement pursuant to Section 163.01, Florida Statutes. A true and correct copy of this Contract and any subsequent amendments shall be filed with the Clerk of the Circuit Court in Pinellas, Pasco and Hillsborough Counties.

SECTION 36. OBLIGATIONS OF MEMBER GOVERNMENTS. All monetary and fiscal obligations of a Member Government arising under this Contract shall be payable solely as described in Section 18(D) hereof.

SECTION 37. CONFLICT WITH INTERLOCAL AGREEMENT. To the extent any provision herein shall conflict with a provision in the Interlocal Agreement, the provision in the Interlocal Agreement shall be controlling.

SECTION 38. GOOD FAITH. The parties hereto agree to exercise good faith and fair dealing in respect to all matters relating to this Contract.

SECTION 39. MISCELLANEOUS PROVISIONS. (A) Whenever the singular is used in this Contract and when required by the context, the same shall include the plural, and the masculine, feminine and neuter genders shall each include the others.

(B) Whenever approvals of any nature are required by any of the parties to this Contract, it is agreed that same shall not be unreasonably withheld, delayed or conditioned, unless the Contract indicates that said approval is within the discretion of one of the parties. Said approval shall promptly be communicated to the requesting party not more than sixty (60) days after its request (or, as to those provisions in this Contract expressly requiring action within a shorter period, then within such period). In the event that the party being called upon for the approval fails to either approve, deny or approve with conditions within said sixty (60) day period (or such shorter period), the request made to the delaying party shall be deemed to be automatically approved, without any further action or notice required by either party, unless the delaying party shall have requested an extension of time for good cause prior to the expiration of the sixty (60) day period (or such shorter period).

(C) It is agreed by and between the parties hereto that all words, terms and conditions contained herein are to be read in concert, each with the other, and that a

provision contained under one heading may be considered to be equally applicable under another in the interpretation of this Contract.

(D) Failure to insist upon the strict compliance of any of the terms, covenants, or conditions hereof shall not be deemed a waiver of such terms, covenants, or conditions, nor shall any waiver or relinquishment of any right or power hereunder at any one time, or times, be deemed a waiver or relinquishment of such right or power at any other time or times or of any other right or power.

IN WITNESS WHEREOF, the Chairman of the West Coast Regional Water Supply Authority has caused this Agreement to be executed and delivered as of the day and year first above written.

ATTEST:

Jerry L. Maxwell
Jerry L. Maxwell, Secretary

WEST COAST REGIONAL WATER
SUPPLY AUTHORITY

By: *Ed Turanchik*
Ed Turanchik, Chairman

David J. Fischer
David J. Fischer, Vice Chairman

Ed Collins
Ed Collins, Director

Steven M. Seibert
Steven M. Seibert, Director

R. Michael Salmon
R. Michael Salmon, Director

Frank Parker
Frank Parker, Director

Date: 6-10-98

(SEAL)

APPROVED AS TO FORM:

Donald D. Conn
Donald D. Conn, General Counsel

[Signature]
WCRWSA Special Counsel

[Signature]



STATE OF FLORIDA
COUNTY OF PINELLAS

The foregoing instrument was acknowledged before me this 10th day of June, 1998, by Ed Turanchik, as Chairman for the West Coast Regional Water Supply Authority.

Krista R. Simon
Notary Public

Print Name



KRISTA R. SIMON
COMMISSION # CC 490328
EXPIRES AUG 21, 1999
BONDED THRU
ATLANTIC BONDING CO., INC.

My Commission Expires:

Personally Known OR Produced Identification _____
Type of Identification Produced _____

IN WITNESS WHEREOF, the Board of County Commissioners of Hillsborough County, Florida, has caused this Agreement to be executed and delivered as of the day and year first above written.

ATTEST:
RICHARD AKE
CLERK OF THE CIRCUIT COURT

HILLSBOROUGH COUNTY, FLORIDA

[Signature]
Deputy Clerk

By: [Signature]
Chairman

Date: 6-10-98

APPROVED AS TO FORM.

(SEAL)

[Signature]
Office of the County Attorney

STATE OF FLORIDA
COUNTY OF HILLSBOROUGH

The foregoing instrument was acknowledged before me this 10th day of June, 1998, by Thomas Scott as Chairman for the Hillsborough County Commission.

[Signature]
Notary Public

Print Name KRISTA R. SIMON
My Commission Expires: COMMISSION # CC 490929
EXPIRES AUG 21, 1999
BONDED THRU ATLANTIC BONDING CO., INC.

Personally Known OR Produced Identification
Type of Identification Produced _____

IN WITNESS WHEREOF, the Board of County Commissioners of Pasco County, Florida, has caused this Agreement to be executed and delivered as of the day and year first above written.

ATTEST:

PASCO COUNTY, FLORIDA

Julia Porpast
Deputy Clerk

By: Julia Young
Chairman
Date: 6-10-98

APPROVED AS TO FORM:

(SEAL)

[Signature]
Office of the County Attorney

IN WITNESS WHEREOF, the Board of County Commissioners of Pinellas County, Florida, has caused this Agreement to be executed and delivered as of the day and year first above written.

ATTEST:
KARLEEN F. DE BLAKER
CLERK OF THE CIRCUIT COURT

PINELLAS COUNTY, FLORIDA

Karleen F. De Blaker
Deputy Clerk

By: Barbara Sheen Todd
Chairman

Date: 6-10-98

APPROVED AS TO FORM:

(SEAL)

Joseph M. Manning
Office of the County Attorney

STATE OF FLORIDA
COUNTY OF PINELLAS

The foregoing instrument was acknowledged before me this 10th day of June, 1998, by Barbara Sheen Todd, as Chairman for Pinellas County, Board of County Commissioners.

Krista R. Simon
Notary Public

Print Name _____
KRISTA R. SIMON
COMMISSION # CC 490323
EXPIRES AUG 21, 1999
BONDED THRU
ATLANTIC BONDING CO., INC.

My Commission Expires:

Personally Known OR Produced Identification _____
Type of Identification Produced _____

IN WITNESS WHEREOF, the City Council of the City of New Port Richey, Florida,
has caused this Agreement to be executed and delivered as of the day and year first
above written.

ATTEST:

CITY OF NEW PORT RICHEY, FLORIDA

Jane Botner
City Clerk

By: *Peter A. Altman*
Mayor

APPROVED AS TO FORM:

(SEAL)

Thomas E. Meers
Office of the City Attorney

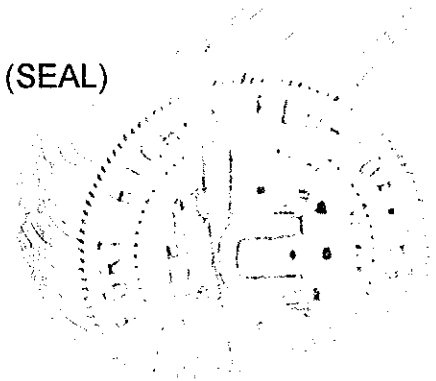

STATE OF FLORIDA
COUNTY OF PASCO

The foregoing instrument was acknowledged before me this 10th day of
June, 1998, by Peter A. Altman, as Mayor for the City of New Port
Richey.

Krista R. Simon
Notary Public

Print Name KRISTA R. SIMON
My Commission Expires: COMMISSION # CC 490323
EXPIRES AUG 21, 1999
BONDED THRU
ATLANTIC BONDING CO., INC.

Personally Known ✓ OR Produced Identification _____
Type of Identification Produced _____

IN WITNESS WHEREOF, the City Council of the City of St. Petersburg, Florida, has caused this Agreement to be executed and delivered as of the day and year first above written.

ATTEST:

CITY OF ST. PETERSBURG, FLORIDA

James K. Brown
City Clerk

By: David S. Fischer
Mayor

APPROVED AS TO FORM:

(SEAL)

[Signature]
Office of the City Attorney

STATE OF FLORIDA
COUNTY OF PINELLAS

The foregoing instrument was acknowledged before me this 10th day of June, 1998, by David S. Fischer, as Mayor for the City of St. Petersburg.

Krista P. Simon
Notary Public

Print Name _____
My Commission Expires _____
KRISTA P. SIMON
COMMISSION # CC 480323
EXPIRES AUG 21, 1999
BONDED THRU
ATLANTIC BONDING CO., INC.

Personally Known ✓ OR Produced Identification _____
Type of Identification Produced _____

IN WITNESS WHEREOF, the City Council of the City of Tampa, Florida, has caused this Agreement to be executed and delivered as of the day and year first above written.

ATTEST:

CITY OF TAMPA, FLORIDA

Janett S. Martin
City Clerk

By: [Signature]
Mayor

APPROVED AS TO FORM:

(SEAL)

[Signature]
Office of the City Attorney

STATE OF FLORIDA
COUNTY OF HILLSBOROUGH

The foregoing instrument was acknowledged before me this 10th day of June, 1998, by Dick Greco, as Mayor of the City of Tampa.

Krista R. Simon
Notary Public

Print Name

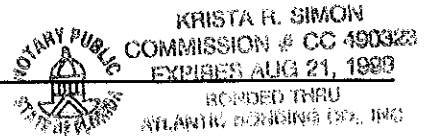

My Commission Expires:

Personally Known OR Produced Identification _____
Type of Identification Produced _____

EXHIBIT A

AUTHORITY'S SYSTEM

EXHIBIT A
AUTHORITY'S SYSTEM
(General Description)
MARCH 23, 1998

EXISTING AUTHORITY ASSETS
TO REMAIN IN AUTHORITY SYSTEM

Cypress Creek Wellfield and Transmission Main – 13 production wells located on 4800 acres in Central Pasco County, of which 3500 acres are owned by SWFWMD, with wellsites licensed to Authority, and 1300 additional acres owned by Authority. Includes six miles of collector and transmission mains 16 inch through 42 inch diameter; associated monitoring wells, and all equipment related thereto.

Cypress Creek Water Treatment Plant – 110 MGD pumping station, chlorination and pH adjustment facilities, 2 - 5 MG water storage tanks, standby emergency electric diesel generators, analytical laboratory, warehouses, administration and maintenance offices, located on 40 acre site licensed from SWFWMD.

Cross Bar Ranch Wellfield and Transmission Main – 17 production wells located on wellsites owned by the Authority in Northern Central Pasco County on property owned by Pinellas County. Includes 20 miles of collector and transmission mains 16 inch through 60 inch diameter, associated monitoring wells; and all equipment related thereto.

Cypress Creek Transmission Main – Includes 19 miles of transmission main 64 through 84 inches in diameter.

U. S. 41 Booster Station – 5 MGD booster facility located on 5 acre site owned by the Authority in Central Pasco County.

West Pasco Booster Station - 3 MGD booster facility located on 1 acre Authority easement in West Pasco County.

Odessa Intertie – 3 MGD meter facility on a 3 acre sites owned by the Authority in West Pasco County.

Morris Bridge Booster Station and Transmission Main – 30 MGD booster facility on 3 acre site licensed to the Authority by the City of Tampa. Includes 5 MG water storage tank and 4 miles of 64 inch diameter transmission main.

Cypress Bridge Wellfield and Transmission Main – 10 production wells located on six (1 to 4 acre) individual sites in Southern Pasco and four - 4 acre individual sites in Northern Hillsborough County, all sites owned by Authority or licensed to Authority. Includes 20 miles of collector and transmission mains 16 inch through 64 inches in diameter, associated monitoring wells; and all equipment related thereto.

Lake Bridge Water Treatment Plant – 5 MGD pumping station, chlorination and pH adjustment facilities, 2-150,000 gallon water storage tanks, located on a 50 acre site owned by the Authority in Northern Hillsborough County.

Northwest Hillsborough Regional Wellfield and Transmission Main – Seven production wells on individual one acre wellsites owned by or licensed to the Authority in Northwest Hillsborough County. Includes 8 miles of collector and transmission mains 12 through 36 inches in diameter, associated monitoring wells; and all equipment related thereto.

Sheldon Road Transmission Main – 1-1/2 miles of 30 inch transmission main in Northwest Hillsborough County.

South Central Hillsborough Regional Wellfield and Transmission Main – 17 production wells on individual 1-4 acre wellsites owned by or licensed to the Authority in Southern Hillsborough County. Includes 19 miles of collector and transmission mains 16 inches through 54 inches in diameter, associated monitoring wells; and all equipment related thereto.

Tampa Bypass Canal Pumping Station – 40 MGD lift station location on the Harney Canal in Hillsborough County on a site licensed by SWFWMD. Includes a 42 inch transmission main, associated monitoring wells; and all equipment related thereto.

Starkey Wellfield – 14 production wells on 8,000 acres owned by SWFWMD in Western Pasco County on wellsites licensed to the Authority by SWFWMD. Includes 8 miles of collector and transmission mains 6 inches through 42 inches in diameter, associated monitoring wells; and all equipment related thereto.

North Pasco Wellfield – Two active production wells, and a total of six sites on one acre sites in western Pasco County on land licensed to the Authority by Pasco County. Includes 4 miles of collector and transmission mains 16 inches through 36 inches in diameter, associated monitoring wells; and all equipment related thereto.

Tampa/Hillsborough Interconnect Booster Station – 1 MGD booster pump station adjacent to North Boulevard in NW Hillsborough County.

**AUTHORITY ASSETS IN PROPERTY ACQUISITION OR CONSTRUCTION
PHASE TO REMAIN IN AUTHORITY SYSTEM**

Cypress Bridge and Morris Bridge Access Roads – Wetland crossing improvements along 17 mile transmission main corridor in Central Pasco and Northern Hillsborough Counties.

Cypress Creek Water Treatment Plant Electrical – 2400 volt switchgear replacement and lightning protection improvements.

Cypress Creek Transmission Main Replacement – Replacement of 8 miles of 84 and 66 inch pipe manufactured by Interpace.

Keller Transmission Main – Replacement of 1.5 miles of 42 and 54 inch pipe manufactured by Interpace.

Tampa/Hillsborough Interconnect Booster Station – New 10 MGD booster facility on site adjacent to North Boulevard in NW Hillsborough County.

Cosme Transmission Main – 8 miles of 48 through 72 inch diameter transmission main.

**EXISTING AUTHORITY ASSETS TO BE TRANSFERRED
BY AUTHORITY TO MEMBERS**

West Pasco Transmission Main (to Pasco County) – Includes 3-1/2 miles of 16 inch through 24 inch diameter transmission main to be transferred to Pasco County.

Lithia WTP and South County Transmission Mains (to Hillsborough County) – 45 MGD pumping station and chlorination facilities. Includes 2 – 5 MG water storage tanks, emergency electric diesel generators, analytical laboratory, warehouse, administration and maintenance offices, located on a 40 acre site owned by Hillsborough County in Southern part of County. Includes 22 miles of transmission mains 24 inches through 42 inches in diameter.

Gardinier Interconnect (to Hillsborough County) – 6 MGD interconnect facility in Southern Hillsborough County.

Tampa/Hillsborough Interconnect Transmission Main (to Hillsborough County and City of Tampa) – 1-1/2 miles of 30 inch transmission main, from Authority to City of Tampa and Hillsborough County.

MEMBER ASSETS TO BE TRANSFERRED BY MEMBERS TO AUTHORITY

Hillsborough County Dispersed Wells - 8 production wells (consisting of The Crippenwood, Manors of Crystal Lake (2), Eagles (2), Truman, Bloomingdale and Highview wells) located on individual sites at various locations owned by Hillsborough County, plus two additional existing interconnect meters between Hillsborough County and the City of Tampa, and two interconnect meters between Hillsborough County and the City of Temple Terrace; and all equipment related thereto.

Cosme/Odessa Wellfield – 23 production wells and monitor wells in Northwest Hillsborough County on land owned by City of St. Petersburg. Includes 5 miles of collector and transmission mains 6 inches through 36 inches in diameter and water treatment plant influent flowmeter; and all equipment related thereto.

Section 21 Wellfield – 6 production wells and monitor wells in Northwest Hillsborough County on land owned by City of St. Petersburg. Includes 3 miles of collector and transmission mains 12 inches through 36 inches in diameter; and all equipment related thereto.

South Pasco Wellfield – 8 production wells and monitor wells in southern Pasco County on land owned by City of St. Petersburg; and all equipment related thereto.

St. Petersburg Transmission Main – 12 miles of 42 inch diameter transmission main located in Southern Pasco and Northwest Hillsborough Counties; and all equipment related thereto.

Eldridge – Wilde Wellfield – 58 production wells and monitor wells located in Northeastern Pinellas and Northwest Hillsborough Counties on lands owned or controlled by Pinellas County. Includes all collector piping and water treatment plant influent flowmeter; and all equipment related thereto.

Morris Bridge Wellfield – Includes 20 production wells, monitor wells, and 8 miles of collector and transmission mains; and all equipment related thereto.

EXHIBIT B

MASTER WATER PLAN

MASTER WATER PLAN

The Master Water Plan, as approved by the Authority's Board of Directors in December 1995, comprised the development of 85 mgd of new supply and three pipeline interties in two phases. Further evaluation of three developmental alternatives and a conservation program to save 17 mgd over the 10 year development period have reinforced the Plan. The Master Water Plan currently includes the following potential new supply projects, as may be subsequently modified by the Authority Board pursuant to the permitting procedures established in the Interlocal Agreement:

Cypress Bridge Permit Increase – Ongoing evaluation of operating and monitoring data for the Cypress Bridge Wellfield, which straddles Hillsborough and Pasco Counties, for potential incremental increase in production above current permitted capacity.

Tampa Bypass Canal – Project looks to utilize available supply from the Tampa Bypass Canal beyond that which is committed as augmentation to the City of Tampa Hillsborough River Reservoir. A component of the Enhanced Surface Water System.

Industrial/Agricultural Exchange/Alafia River – Proposes to capture seasonally variable available flows from the Alafia River and Lithia Springs for storage in an off-stream reservoir. A component of the Enhanced Surface Water System.

Hillsborough River High Water – Proposes to harvest a portion of wet-season flows in the Hillsborough River after City of Tampa and downstream ecological needs have been met. A component of the Enhanced Surface Water System.

Enhanced Surface Water System – The previous three supply projects (Tampa Bypass Canal, Industrial/Agricultural Exchange/Alafia River, and Hillsborough River High Water) with the South Central Hillsborough Intertie. The Enhanced Surface Water system realizes greater yields and increased efficiencies over the individual projects through shared conveyance, storage, and treatment facilities.

Brandon Urban Dispersed Wells – Selective redevelopment of groundwater supply in the Brandon area.

Cone Ranch and Dispersed Wells – Project to develop long-planned available groundwater supply in Northeast Hillsborough County in conjunction with hydrologic restoration.

Hillsborough Bay Resource Exchange – Indirect potable reuse through supplemental treatment of H.F. Curren effluent and subsequent augmentation of Tampa Bypass Canal. Public acceptability currently being evaluated.

Seawater Desalination – Investigation of this supply option through issuance of a request for proposals for privatized development and subsequent evaluation of responses.

Brackish Water Desalination – Continued evaluation by Authority and Member Governments of opportunities for development of brackish water supplies.

Exhibit B is provided for informational purposes only.

EXHIBIT C

POINTS OF CONNECTION

**EXHIBIT C
POINTS OF CONNECTION INFORMATION**

MEMBER	FACILITY SUPPLIED	POINT OF CONNECTION	QUALITY WATER PROPOSED TO BE DELIVERED	CREDIT NEEDED TO OBTAIN QUALITY WATER	ANTICIPATED AMOUNT OF CREDIT \$/1000 GALLONS	DESIGN PRESSURE AT POINT OF CONNECTION	NOTES
Pasco County	U.S. 41 Intertie	Booster Pump Discharge	Yes	No	0	80 psig	
	Odessa Intertie	Flowmeter Outlet	Yes	No	0	50 psig (80 psig upon relocation)	To be relocated by County or combined w/Pasco Intertie Meter
	W. Pasco Intertie	Booster Pump Discharge	Yes	No	0	80 psig	To be relocated by County
	Lake Bridge WTP	HSP Discharge	Yes	No	0	80 psig	
	Little Road WTP	Starkey WF Flowmeter Outlet	No	Yes	\$0.05	Aerator Tray Elevation, Ft.	
Hillsborough County	Lake Park WTP	Plant Inf Flowmeter Outlet	Yes	No	0	40 psig	
	NW Hillsborough PWF	Plant Inf Flowmeter Outlet	No	Yes	\$0.01	40 psig	
	Tampa/Hillsborough Interconnection	Booster Pump discharge	Yes	No	0	80 psig	
	Lithia WTP	Plant Inf Flowmeter Outlet	No	Yes	\$0.05	Aerator Tray Elevation, Ft.	
	Crippenwood	Well Flowmeter Outlet	No	Yes	\$0.05	65 psig	Iron
	Manors of Crystal Lake	Well Flowmeter Outlet	Yes	No	0	70 psig	
	Eagles	Well Flowmeter Outlet	No	Yes	\$0.05	70 psig	
	Truman	Well Flowmeter Outlet	Yes	No	0	40 psig	
	Bloomingtondale	Well Flowmeter Outlet	Yes	No	0	40 psig	
	Highview	Well Flowmeter Outlet	Yes	No	0	70 psig	
	U.S. 41/Progress Village	U.S. 41 from City of Tampa to Hillsborough County	Yes	No	0	50 psig	
	Waters Avenue/UPS	Waters Avenue from City of Tampa to Hillsborough County	Yes	No	0	50 psig	
	U.S. 301/Jefferson Rd.	U.S. 301 from City of Temple Terrace to Hillsborough County	Yes	No	0	50 psig	
	U.S. 301/Williams Rd.	U.S. 301 from City of Temple Terrace to Hillsborough County	Yes	No	0	50 psig	
New Port Richey	Maytum WTP	Plant Inf Flowmeter Outlet	No	Yes	\$0.05	Aerator Tray Elevation, Ft.	

PINELLAS COUNTY FLA.
OFF. REC. BK 10155 PG 391

OR BK 3967 PG 626
195 of 1055

PAGE 2 (CONT) EXHIBIT C - POINTS OF CONNECTION INFORMATION

MEMBER	FACILITY SUPPLIED	POINT OF CONNECTION	QUALITY WATER PROPOSED TO BE DELIVERED	CREDIT NEEDED TO OBTAIN QUALITY WATER	ANTICIPATED AMOUNT OF CREDIT \$/1000 GALLONS	DESIGN PRESSURE AT POINT OF CONNECTION	NOTES
Pinellas County	S.K. Keller WTP - from Regional System	Flowmeter Outlets (54 inch and 42 inch)	Yes	No	0	75 psig	54" meter to be relocated by WCRWSA 42" meter to be eliminated
	S.K. Keller WTP - from Eldridge Wilde WF	Plant Inf Flowmeter Outlet	No	Yes	\$0.05	20 psig	
St. Petersburg	Cosme WTP	Plant Inf Flowmeter Outlet	No	Yes	\$0.01	Aerator Tray Elevation Ft.	To be replaced by WCRWSA
	Cosme WTP	NWHRWF Flowmeter Outlet	No	Yes	\$0.01	Aerator Tray Elevation Ft.	To be deleted upon completion of Cosme TM by WCRWSA
	Cosme WTP	Bypass Flowmeter Outlet	Yes	No	\$0.00	70 psig	To be constructed by WCRWSA
Tampa	Morris Bridge WTP	New Plant Inf Flowmeter Outlet	No	Yes	\$0.05	Treatment Unit Pressure Requirement, psig	To be installed by WCRWSA
	Hillsborough River Reservoir (from Tampa Bypass Canal)	Hillsborough River Reservoir	NA	NA	NA	Reservoir Elevation, Ft.	Not subject to WQ standards

PINELLAS COUNTY FLA.
 OFF. REC. BK 10155 PG 382
 OR BK 3967 PG 627
 196 of 1055

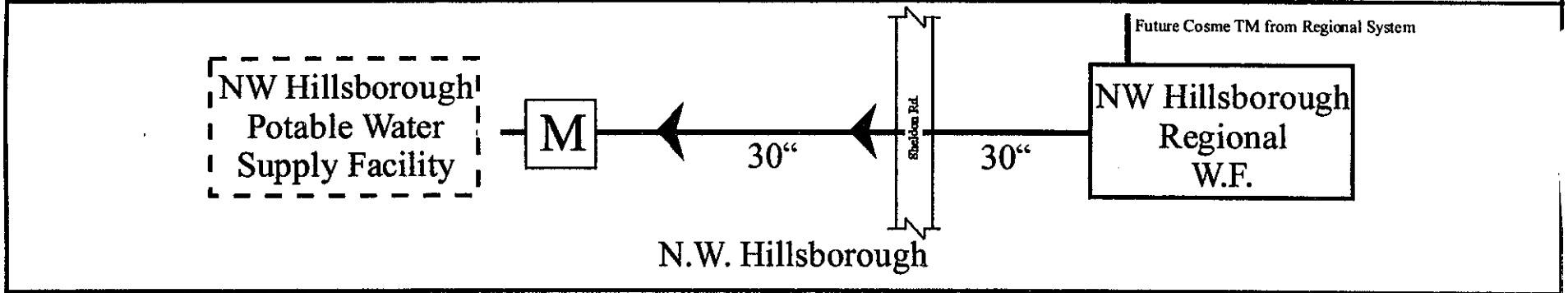
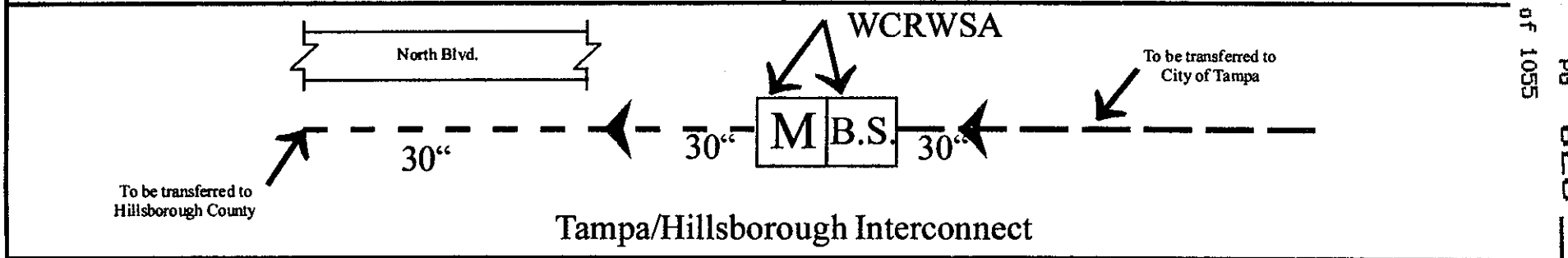
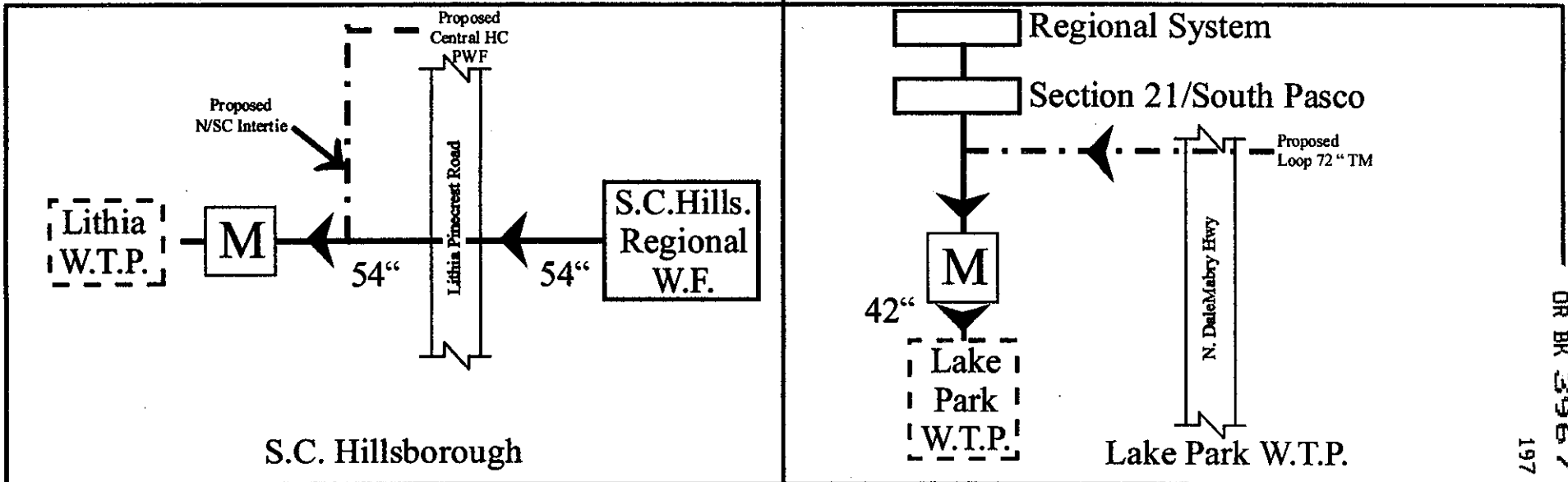



Hillsborough County
Points of Connection

Pg 1 of 2

— WCRWSA

- - - Hillsborough County

— City of Tampa

- . . . Proposed WCRWSA

● Connected Pipes

M Flow Meter

B.S. Booster Station

FILE: o:\cor\Hills\ken herd/HHUCo

DATE: 03/20/98

DRAWN BY: R.L.S.

DR BK 3967 PG 628
 197 of 1055

PINELLAS COUNTY FLA
 OFF. REC. BK 10155 PG 393

DR BOOK 09143 PAGE 0197

6610 51160

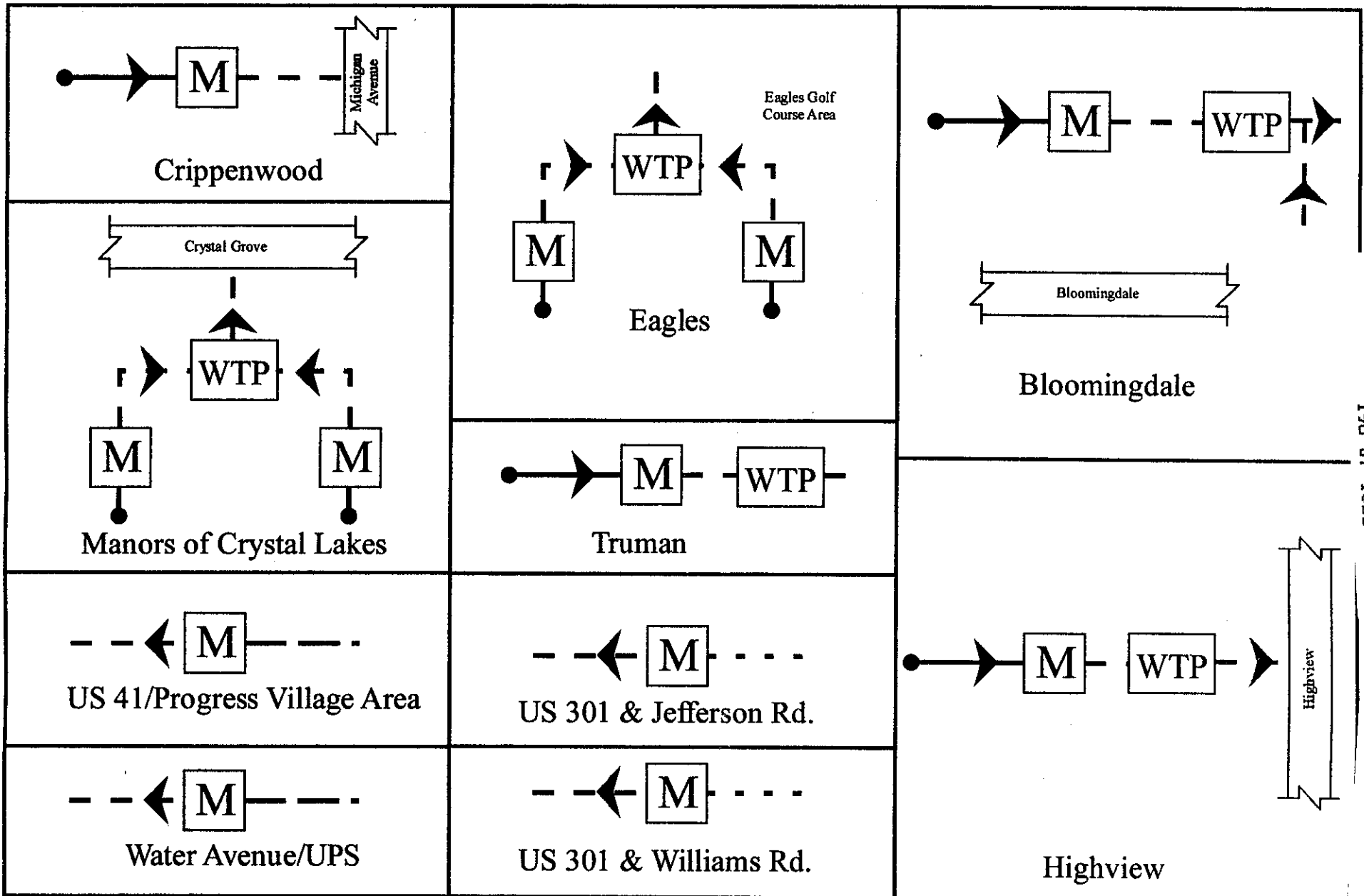

DR BK 3967 PG 629
 198 of 1055
 PINELLAS COUNTY FLA.
 OFF. REC. BK 10155 PG 394

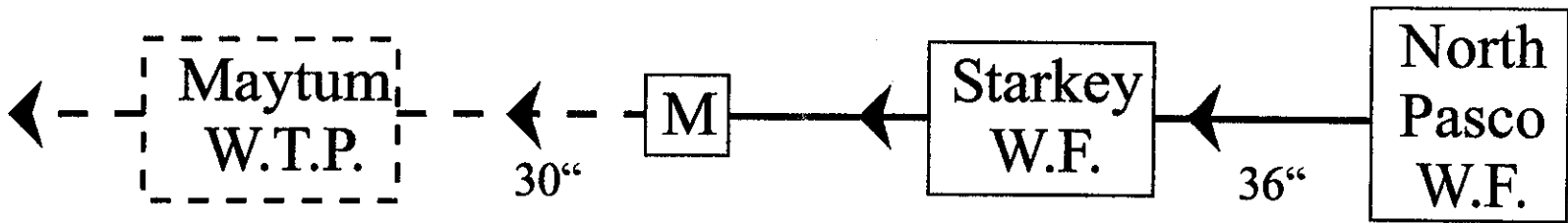
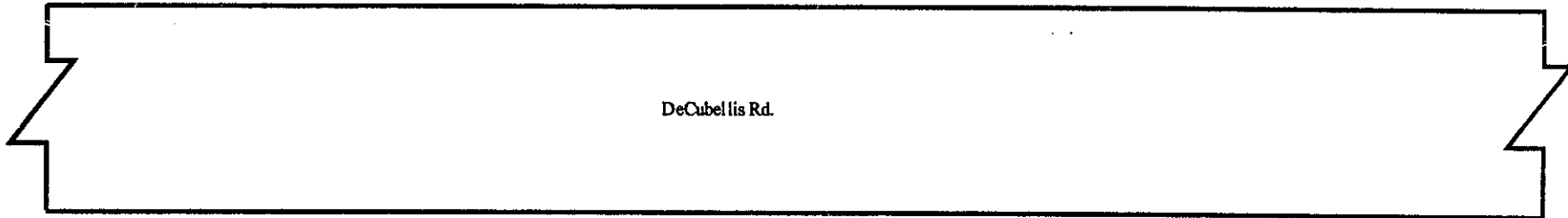

	<h2 style="margin: 0;">Hillsborough County</h2> <h1 style="margin: 0;">Points of Connection</h1>	<ul style="list-style-type: none"> ———— WCRWSA - - - - Hillsborough County ———— City of Tampa - - - - City of Temple Terrace - - - - Proposed WCRWSA 	<ul style="list-style-type: none"> ● Connected Pipes M Flow Meter 	<p>FILE 020907Res/ken herd/Hills Co/led.</p> <p>DATE: 03/20/98</p> <p>DRAWN BY: R.L.S.</p>
---	--	---	---	--

8610 8/13



City of New Port Richey Point of Connection

Pg 1 of 1

-  WCRWSA
-  New Port Richey
-  Connected Pipes

 Flow Meter

FILE: o:corefiles/ken hard/NPR
DATE: 03/20/98
DRAWN BY: R.L.S.

6610 3967
09143

OR BK 3967 PG 631
 200 of 1055
 PINELLAS COUNTY FLA.
 OFF. REC. BK 10155 PG 396

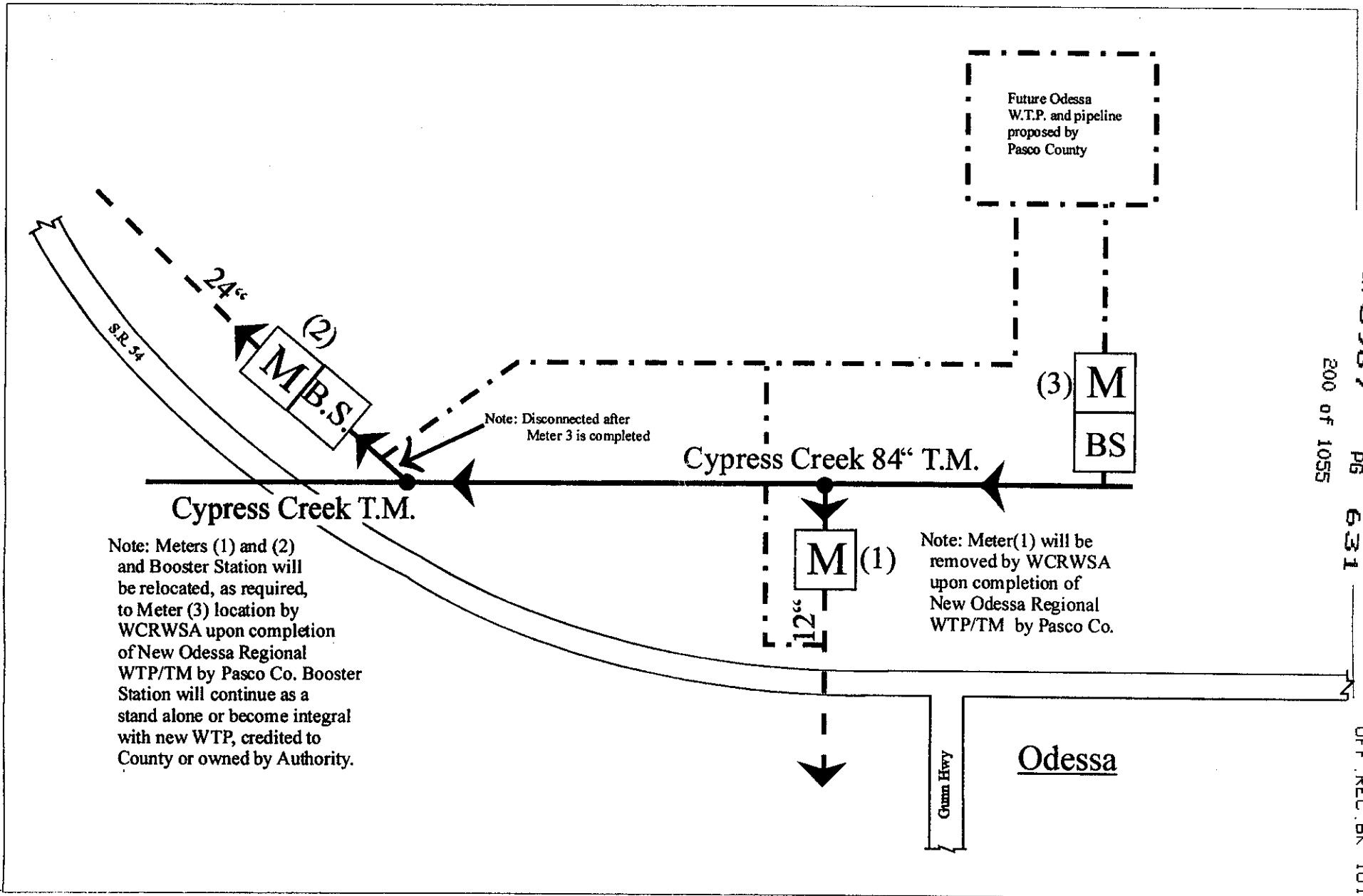

Note: Meters (1) and (2) and Booster Station will be relocated, as required, to Meter (3) location by WCRWSA upon completion of New Odessa Regional WTP/TM by Pasco Co. Booster Station will continue as a stand alone or become integral with new WTP, credited to County or owned by Authority.

Note: Disconnected after Meter 3 is completed

Note: Meter(1) will be removed by WCRWSA upon completion of New Odessa Regional WTP/TM by Pasco Co.



Pasco County Points of Connection

- WCRWSA
- - - - - Pasco County
- . - . - Proposed Pasco County

- Connected Pipes
- [M] Flow Meter
- [BS] Booster Station

FILE: o:\corefiles\ken herd\PasCo
 DATE: 03/20/98
 DRAWN BY: R.L.S.

OR BK 3967 PG 632
201 of 1055

PINELLAS COUNTY FLA.
OFF. REC. BK 10155 PG 397

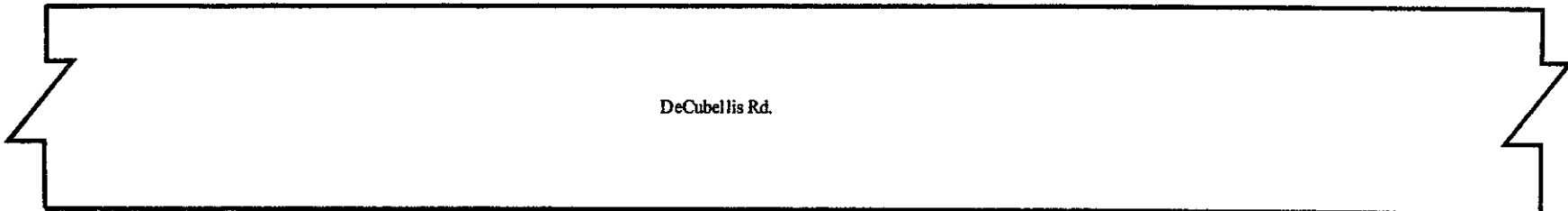
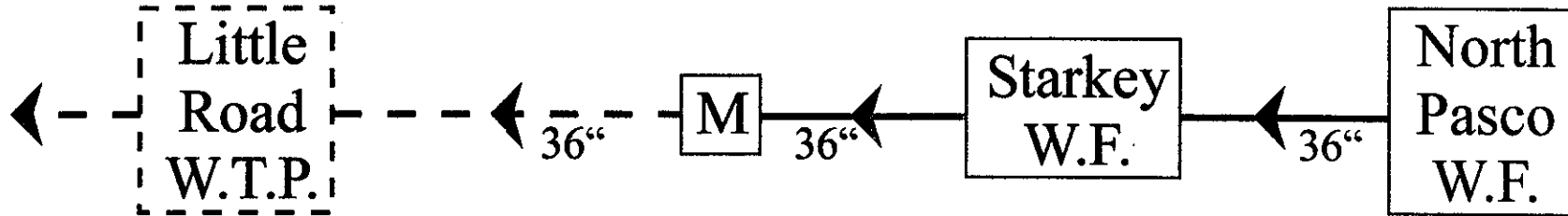

DeCubellis Rd.

	<h2 style="text-align: center;">Pasco County</h2> <h1 style="text-align: center;">Points of Connection</h1> <p style="text-align: right;">Pg 2 of 3</p>	<p>— WCRWSA</p> <p>- - - Pasco County</p> <p>● Connected Pipes</p>	<p>M Flow Meter</p>	<p>FILE: orcorfiles/ken herd/PasCo2</p> <p>DATE: 03/20/98</p> <p>DRAWN BY: R.L.S.</p>
--	---	--	---	---

1000 2/1/00

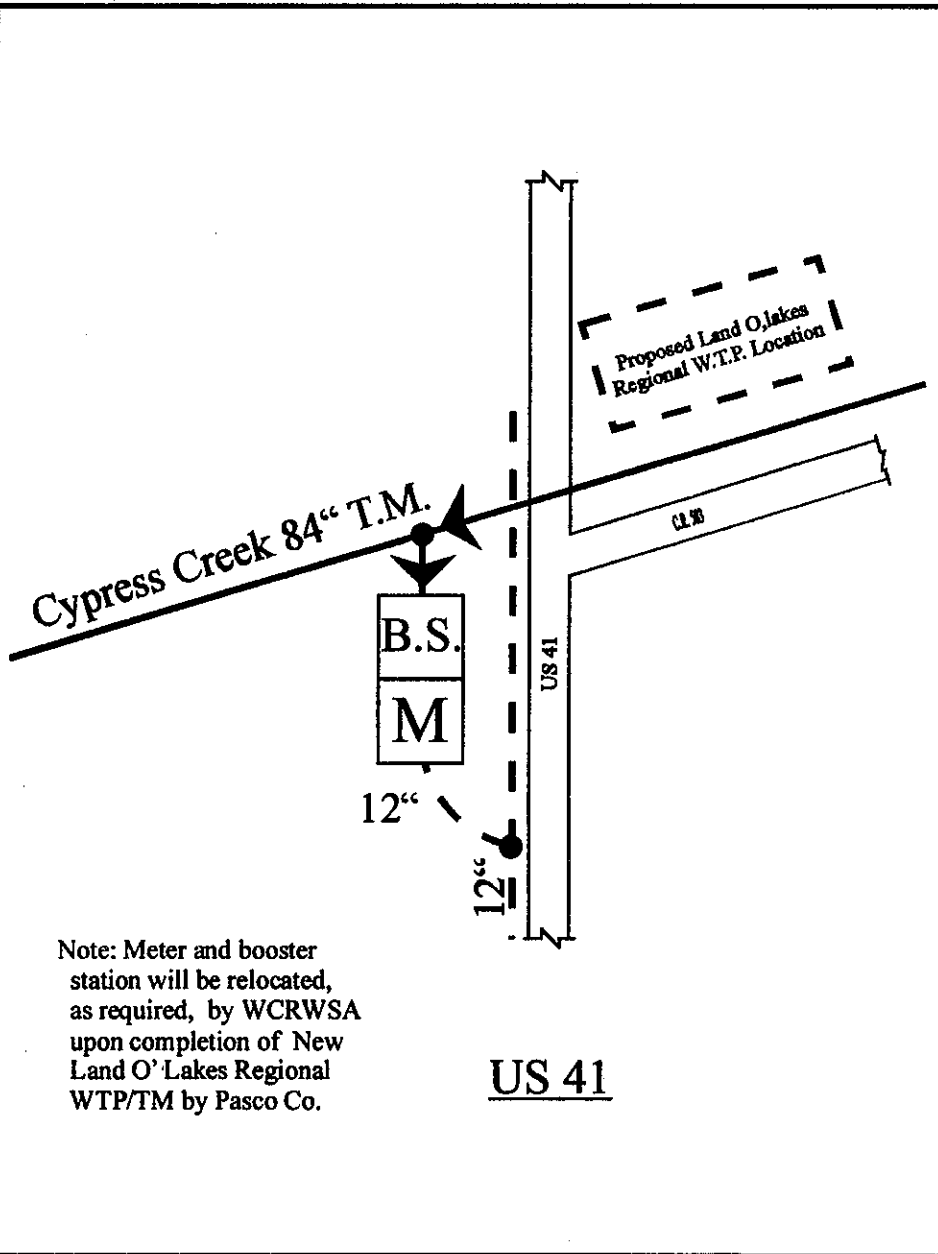

Note: Meter and booster station will be relocated, as required, by WCRWSA upon completion of New Land O' Lakes Regional WTP/TM by Pasco Co.

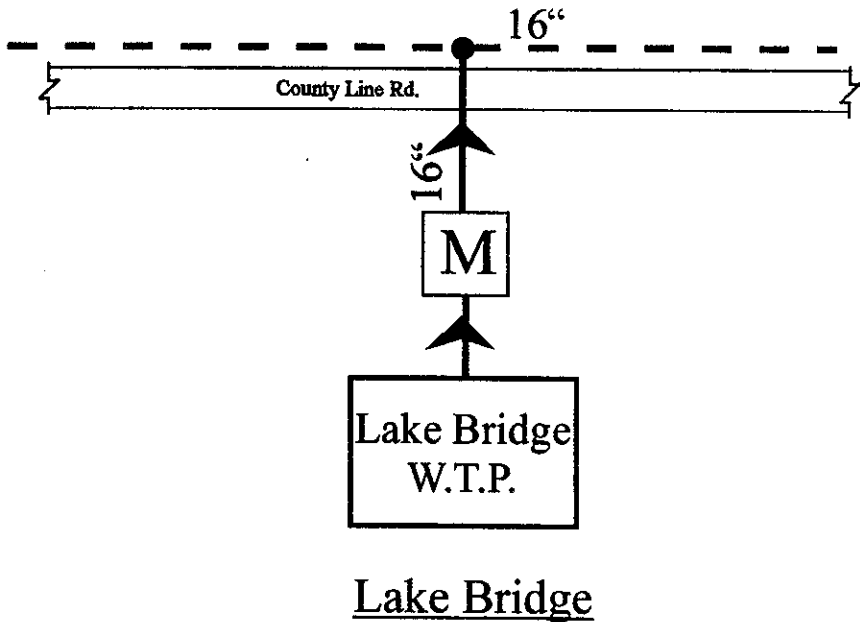

DR BK 3967 PG 633
 202 of 1055
 PINELLAS COUNTY FLA.
 OFF. REC. BK 10155 PG 398

Pasco County Points of Connection

Pg 3 of 3

	WCRWSA		Flow Meter
	Pasco County		Booster Station
	Connected Pipes		

FILE: o:\corefiles\ken hord\PasCo
 DATE: 03/20/98
 DRAWN BY: R.L.S.

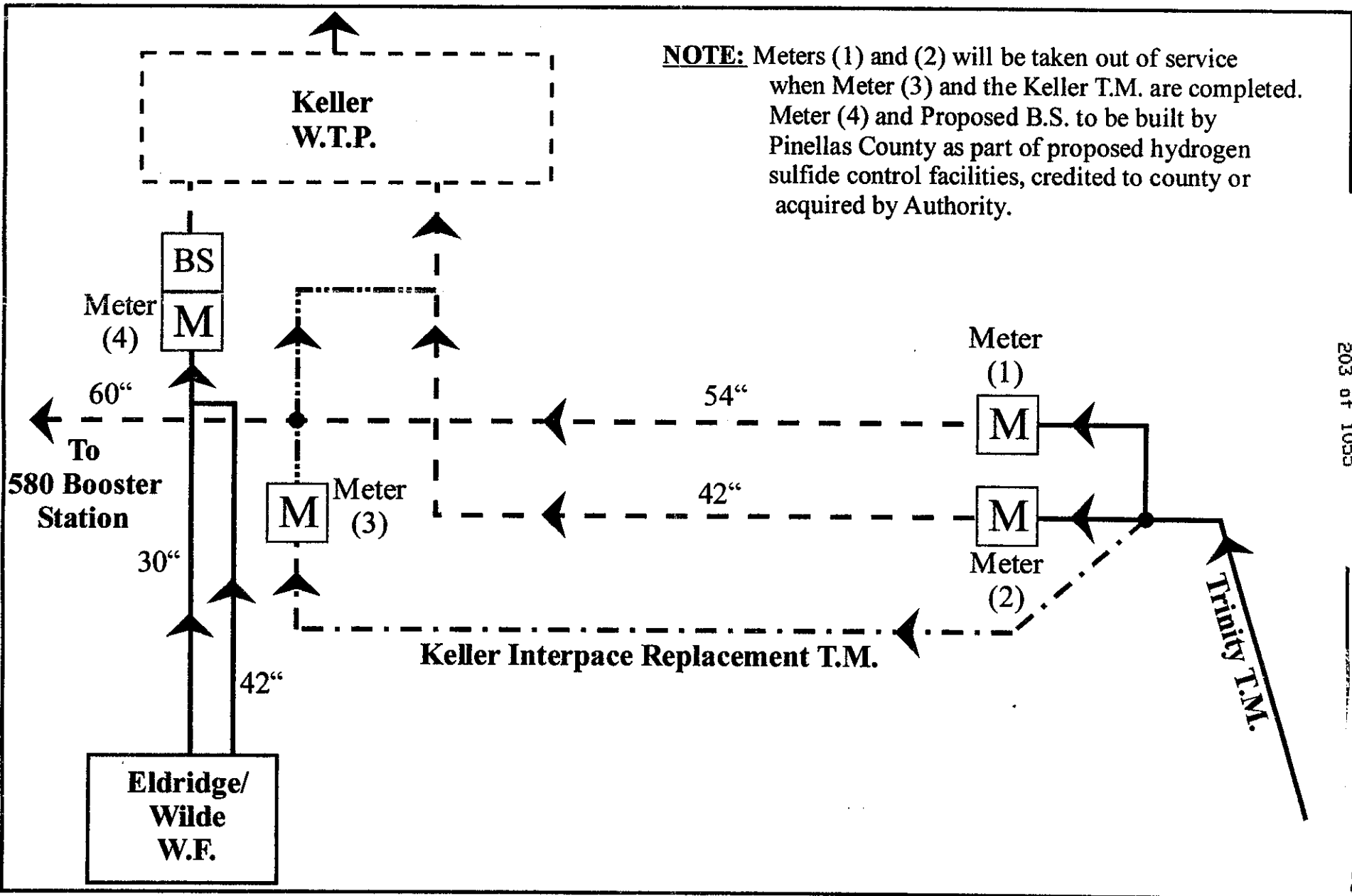

NOTE: Meters (1) and (2) will be taken out of service when Meter (3) and the Keller T.M. are completed. Meter (4) and Proposed B.S. to be built by Pinellas County as part of proposed hydrogen sulfide control facilities, credited to county or acquired by Authority.

DR BK 3967 PG 634 OFF REC BK 10155 PG 399
 PINELLAS COUNTY FLA.



Pinellas County Points of Connection

Pg 1 of 1

- WCRWSA
- - - Pinellas County
- . - . - Proposed WCRWSA
- Proposed built by WCRWSA and owned by Pinellas County
- Connected Pipes
- M Flow Meter
- BS Proposed Booster Station

FILE: o:\corefiles\ken herd\Pine Co
 DATE: 03/20/98
 DRAWN BY: R.L.S.

8090 8110

Cosme T.M.

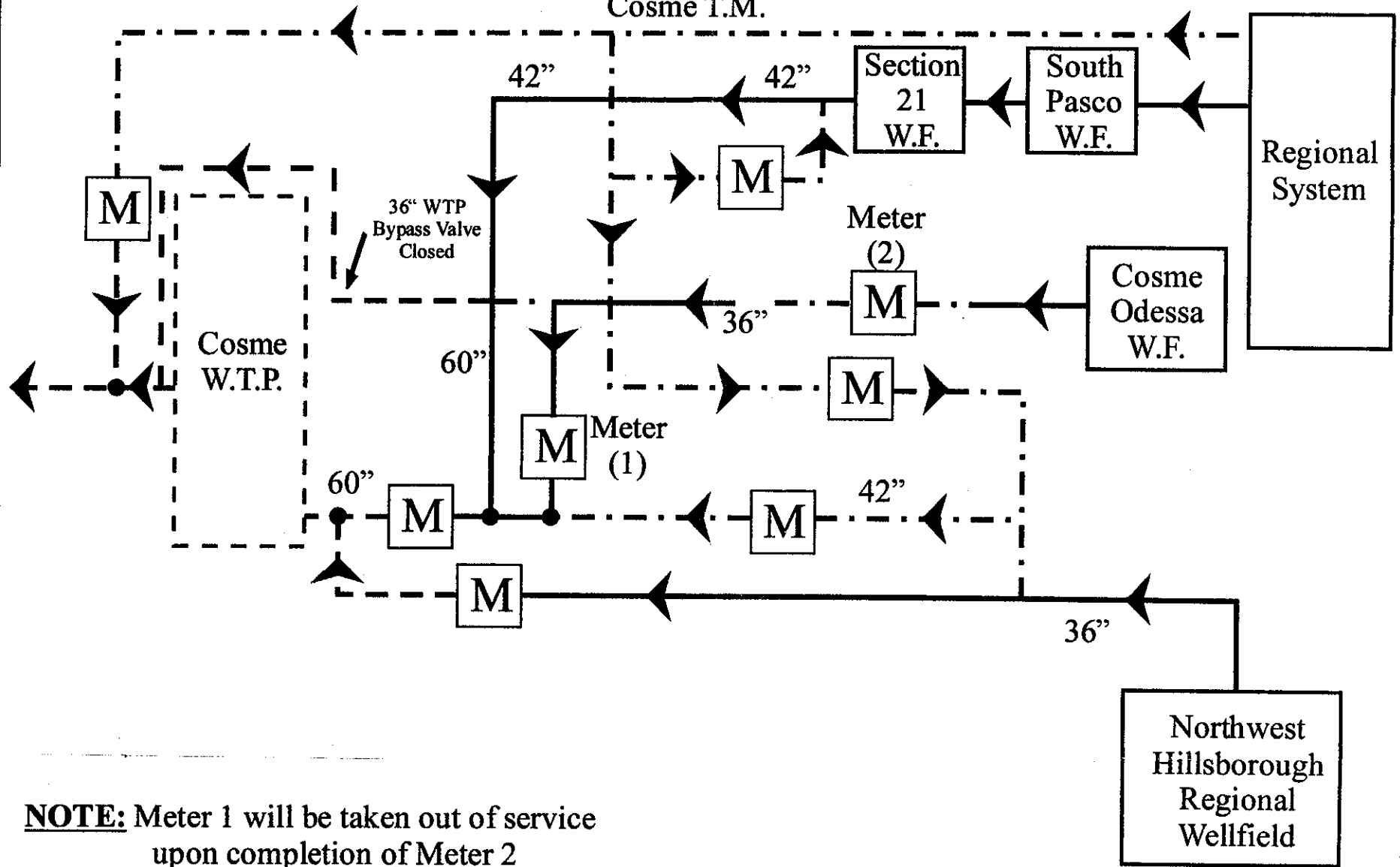

NOTE: Meter 1 will be taken out of service upon completion of Meter 2

OR BK 3967 PG 635
204 of 1055
PINELLAS COUNTY FLA.
OFF. REC. BK 10155 PG 400



**City of St. Petersburg
Points of Connection**

- WCRWSA
- - - City of St. Petersburg
- . . . Proposed WCRWSA
- Connected Pipes

FILE: o:\core\files\ken hord\Cosme1
DATE: 03/20/98
DRAWN BY: R.L.S.

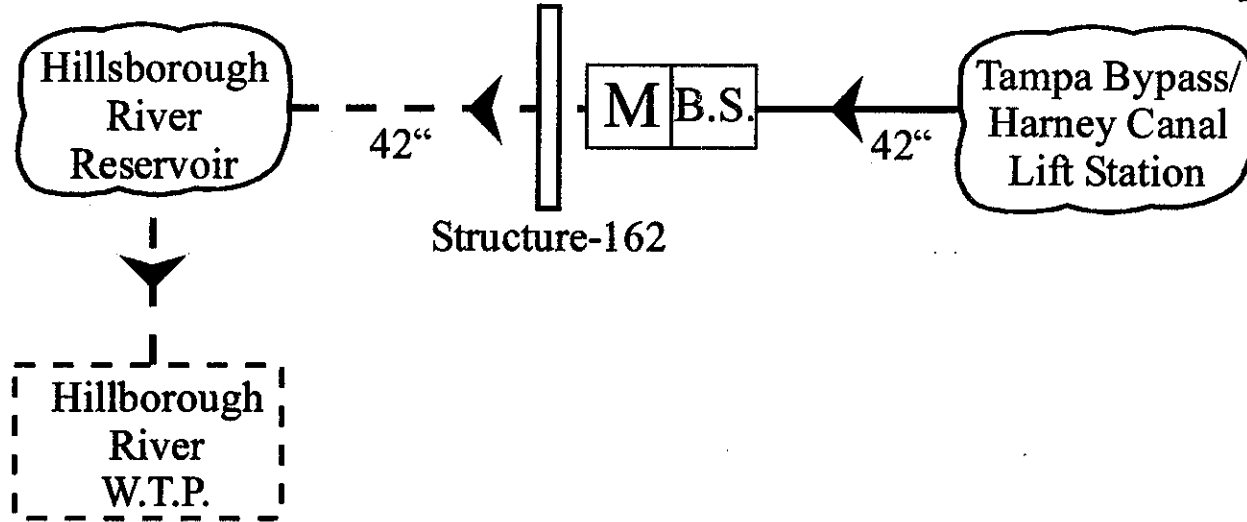

DR BK 3967 PG 636
205 of 1055

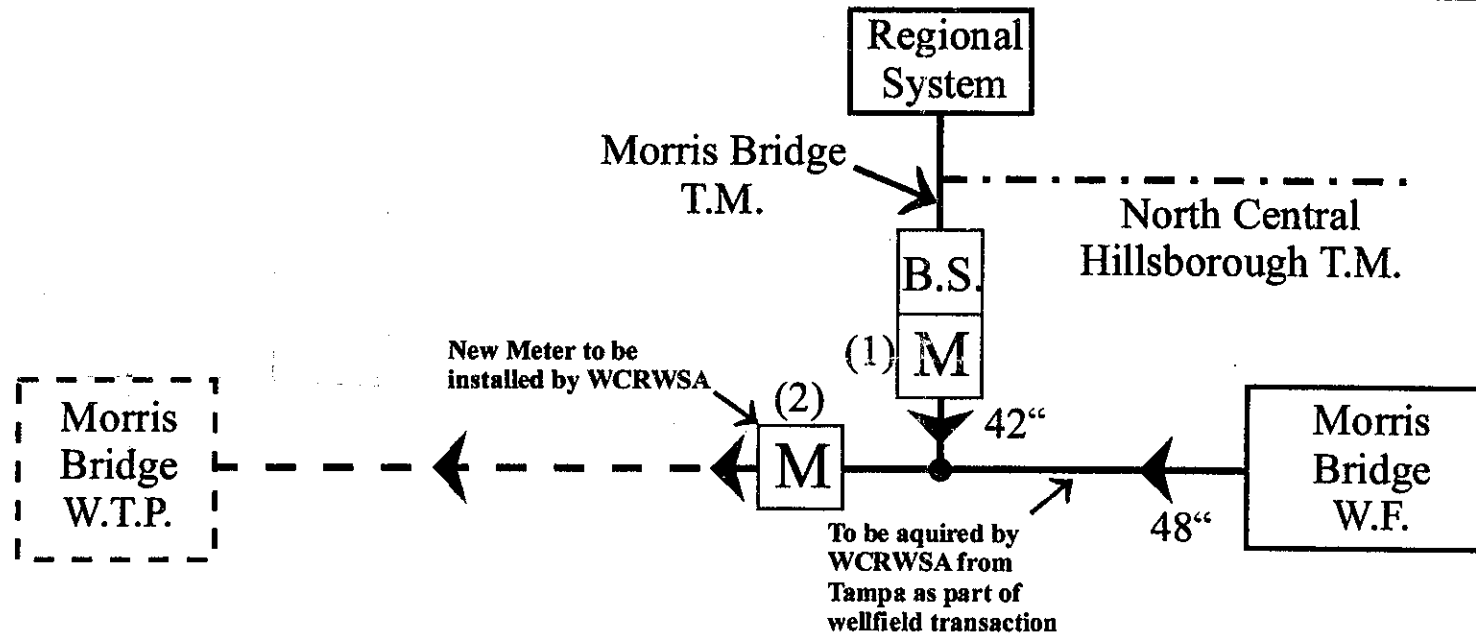

PINELLAS COUNTY FLA.
OFF. REC. BK 10155 PG 401



City of Tampa Points of Connection

- WCRWSA
- - - - - City of Tampa
- Proposed by WCRWSA

- M** Flow Meter
- B.S.** Booster Station
- Connected Pipes

FILE: 0:\corefiles\ken herd\CoT
 DATE: 03/20/98
 DRAWN BY: R.L.S.

EXHIBIT D

SUPPLEMENTAL WATER QUALITY PARAMETERS

EXHIBIT D

SUPPLEMENTAL WATER QUALITY PARAMETERS

Water supplied from the Authority's System shall be sampled annually at a minimum, at the Point(s) of Connection for the following parameters. The Quality Water definition and the supplemental parameters listed below define the water quality to be provided by the Authority:

<u>Contaminant</u>	<u>Goal</u>
Sulfides	0.1 mg/l
Total Hardness	300 mg/l as CaCO ₃
Alkalinity	40 mg/l as CaCO ₃ (minimum value)

Note: Supplemental parameters are not currently included in S.F.D.E.P. 62-550.

The results of the annual sampling program shall be provided to all the Member Governments in a report format. The cost of the annual sampling program shall be borne by the Authority as an Operation, Maintenance and Administrative Cost to be shared equitably among its Members. In the event that the annual sampling program indicates the maximum contaminant level from the table is exceeded for one or more parameter, the Authority shall follow the retesting and mitigative measures currently defined in State and Federal regulations.

Within 60 days of February 23, 1998, or the next following regularly scheduled meeting of the Authority's Board of Directors, the Authority and Member Governments shall propose a list of a minimum of 19 Supplemental Water Quality parameters and assigned levels for Board approval. Such list, when approved by the Board, shall supplement this Exhibit D. Any Member Government that does not concur with the amended list of parameters or their assigned levels, shall be entitled to seek relief by the arbitration process established in Section 19 of the Contract. The standards for the arbitration process shall be:

1. Whether cost-effective alternative water supplies can be developed consistent with Master Water Plan objectives, including diversity of supply sources, and
2. Whether Quality Water delivered by the Authority would not cause a particular Member Government utility to adopt new treatment techniques beyond modified chemical dosages and/or optimization of existing unit processes, to meet a moderately altered source of Quality Water.

In the event that a Member Government requests sampling for additional parameters or an increase in sampling frequency, the cost associated with the sampling will be borne solely by that Member Government and not by the Authority. If scheduling permits, the Authority may provide the sampling services at cost to the Member Government or the Member Government may perform the additional testing.

Sampling shall be conducted in accordance with the procedures defined in the current regulations for the Primary and Secondary Drinking Water Standards and/or according to Standard Methods, latest edition, for those parameters for which testing procedures are not defined in the regulations.

The Authority shall evaluate each new supply element to ensure that:

1. Quality Water is provided that at a minimum, meets all Federal and State drinking water quality standards with the exception of corrosion control and disinfection so as to protect public health and safety and provide water as aesthetically-pleasing as is currently supplied.
2. Individual Member Governments will continue to provide additional treatment to meet their individual utility-specific water quality goals and customer expectations for level of service.
3. Member Governments, acting through the Authority, may provide for common water quality goal-related elective standards more stringent than Federal and State drinking water standards, and.
4. Cost-effective alternative water supplies are developed consistent with Master Water Plan objectives, including diversity of supply sources, and
5. Quality Water delivered by the Authority would not cause a particular Member Government utility to adopt new treatment techniques beyond modified chemical dosages and/or optimization of existing unit processes, to meet a moderately altered source of Quality Water.

Prior to the initiation of any new supply element, a formal review against the criteria set forth above shall be performed by the Authority to evaluate anticipated finished water quality, impacts to existing system water supply quality, and impacts to current member government-specific water treatment practices and costs. This review shall include the presentation of an anticipated raw water operating schedule that defines for each individual Member Government the predominant raw water source, potential significant additional raw water sources, water quality parameters and anticipated levels, and frequency of significant water quality changes.

EXHIBIT E

WATER SERVICE AREAS

OR BK 3967

PG

641

210 of 1055

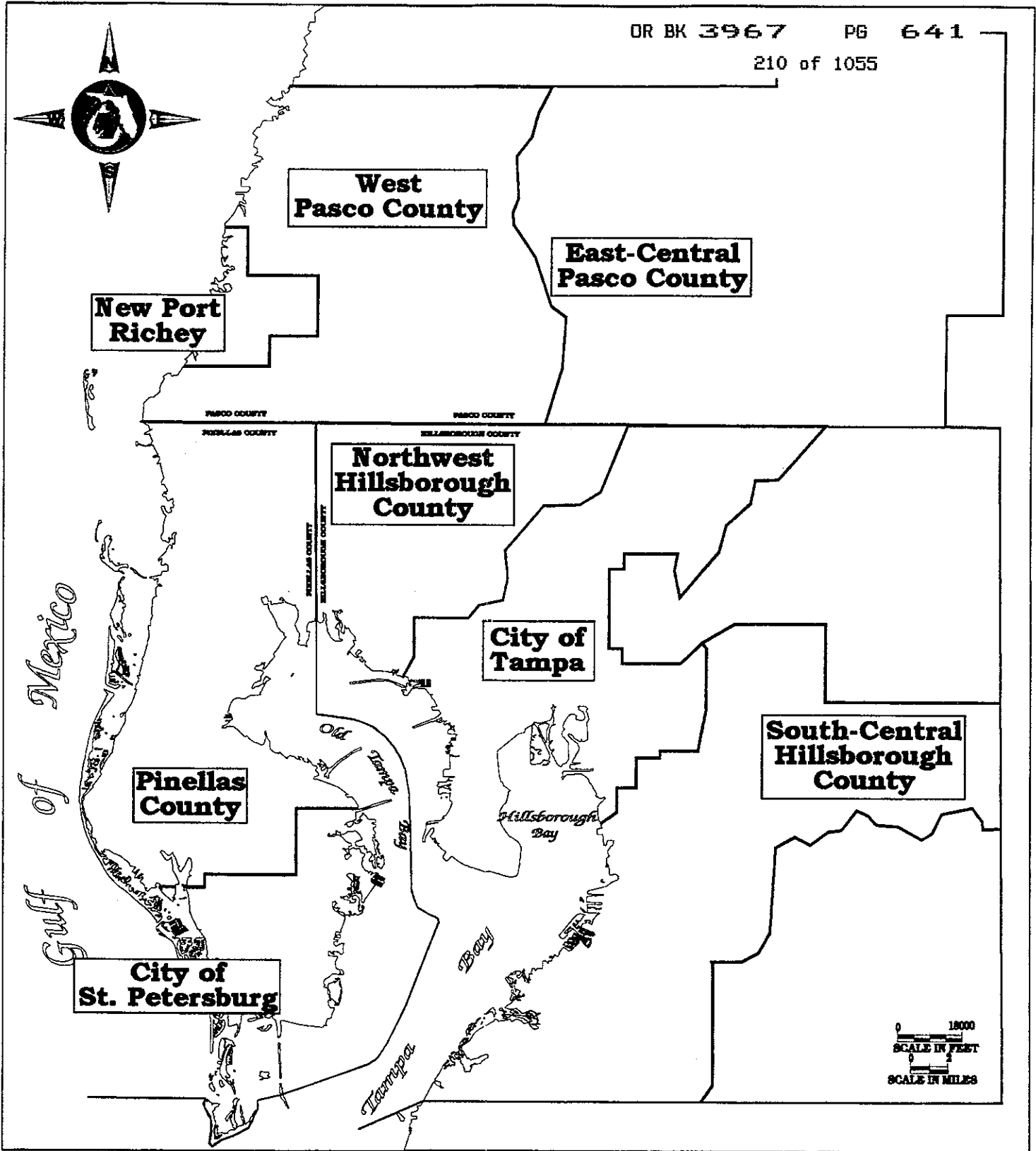

The Authority in Water

Member Government Water Service Areas

Date: 3/24/98

Checked: J.R.

Drawn By: J.R.

File Name: Service.cdr

EXHIBIT F

RATE

EXHIBIT F

West Coast Regional Water Supply Authority
Unitary Rate for Fiscal Year 1998
Equity Model Scenario Revised March 23, 1998

Expenditures	Projected FY 1998
Debt Service for Existing Facilities	\$ 6,865,736
Salaries and Wages	\$ 5,639,326
Professional, Legal and Other Services	\$ 7,837,434
Other Operating Costs	\$ 9,956,815
Non-Oper Project Expenses & Capital Equipment	\$ 753,079
Annual Credit for Acquired Facilities, Land and Treatment Allowances	\$ 26,846,309
Debt Service for Capital Improvement Projects	\$ 2,073,321
Less Revenues from TBC (15mgd @ \$.08/1000 gallons)	\$ (438,000)
Less Interest Earned	\$ (656,000)
Additional Professional and Legal Services (Acquired Facilities)	\$ 3,325,000
Less Contribution from Regional System Fund Balance	\$ (5,057,716)
Total Projected Expenditures	\$ 57,145,305

West Coast Regional Water Supply Authority
Water Demand Projection

Water Consumption Projections	Projected FY 1998	Projected Percentage
Hillsborough County	34.13	21%
City of Tampa (See Note 1)	5.00	3%
Pasco County	14.66	9%
City of New Port Richey	3.95	2%
Pinellas County	68.89	42%
City of St. Petersburg	37.50	23%
Total Projected Water Demand (MGD)	164.13	100%

Projected Unitary Water Rate \$/1000 gallons	0.9539
Projected Fixed Total	\$ 50,245,305
Projected Variable Total	\$ 6,900,000
	<u>\$ 57,145,305</u>

Note:

- [1] For Unitary Rate Budget purposes, it is assumed that the City of Tampa will receive
 - >> 15.0 mgd of untreated surface water (TBC) @ \$.08/1,000 gallons
 - >> 5.0 mgd of ground water from the Authority's other water supply facilities
- [2] **Acquired Facilities:** Members have the option of receiving lump sum cash or a 30year monthly credit for the Transferred Facilities. The payments are used to offset the cost of water purchased from the Authority. Any tables which estimate Members cost will show a yearly reduction associated with these facilities. If a member takes the lump sum payment the member will control the amount of yearly offset of cost and will not receive a monthly credit from the Authority.
- [3] **Acquired Facilities:** The interest rate for the actual debt service and associated credits will be fixed based upon the municipal interest rates at the time of financing as detailed in the Amended and Restated Interlocal Agreement.

EXHIBIT G

TERMINATED AGREEMENTS

- (1) Transmission Line Agreement by and between St. Petersburg and Pinellas dated July 10, 1973
- (2) Agreement for Development and Operation of the Cypress Creek Wellfield by and between Pinellas, Pasco and St. Petersburg dated August 30, 1974
- (3) Interlocal Agreement Creating WCRWSA dated October 25, 1974 and First Amendment dated May 31, 1977
- (4) Agreement by and between Pinellas and Pasco Water Authority, Inc. dated July 7, 1976 and Addendum dated January 1, 1977
- (5) Agreement by and between Pinellas and Pasco Water Authority, Inc. dated January 11, 1977
- (6) Cross Bar Ranch Wellfield Water Supply Agreement by and between Pinellas and WCRWSA dated April 11, 1979 and Amendment dated January 29, 1980
- (7) Agreement by and between Hillsborough and WCRWSA dated August 28, 1980
- (8) Agreement by and between St. Petersburg and WCRWSA dated September 17, 1980
- (9) Water Supply Contract for Hillsborough County by and between Hillsborough and WCRWSA dated November 10, 1981, along with First Amendment dated August 11, 1982, Second Amendment dated November 23, 1983, Third Amendment dated November 6, 1985, Fourth Amendment dated November 6, 1985, Fifth Amendment dated October 4, 1989, Sixth Amendment dated December 6, 1989, Seventh Amendment dated April 4, 1990, Eighth Amendment dated January 22, 1992, Ninth Amendment dated October 6, 1993, Tenth Amendment dated April 5, 1995 and Eleventh Amendment dated February 21, 1996
- (10) Water Exchange Contract by and between St. Petersburg and WCRWSA dated December 4, 1981 and First Amendment dated April 14, 1984
- (11) Starkey Wellfield Water Supply Contract by and between Pasco, New Port Richey and WCRWSA dated December 15, 1981 and the First Amendment dated October 29, 1982 and the Second Amendment dated June 7, 1988.

(12) Exclusive Water Purchase Agreement by and between Pasco, S.C. Bexley, Angeline Corporation, and L.S.B. Corporation dated August 25, 1983

(13) Water Supply Contract for Tampa Bypass Canal by and between Tampa and WCRWSA dated January 17, 1985

(14) Operation and Management Agreement by and between St. Petersburg and WCRWSA dated March 16, 1987

(15) Surplus Water Supply Contract by and between Hillsborough and WCRWSA dated April 29, 1987

(16) South Central Pasco Water Supply Contract by and between Pasco and WCRWSA dated June 7, 1988

(17) Pasco Excess Water Supply Contract by and between Pasco and WCRWSA dated November 1, 1988

(18) North Pasco Regional Wellfield Water Supply Contract by and between Pasco, New Port Richey and WCRWSA dated January 23, 1990

(19) Agreement to Finance 84 and 66 Inch Investigation and Litigation by and between Pinellas, Pasco, Hillsborough, St. Petersburg and WCRWSA dated December 11, 1990

(20) Regional System Water Supply Contract by and between Pinellas, Pasco, Hillsborough, Tampa, St. Petersburg and WCRWSA dated July 24, 1991

(21) Agreement to Finance Regional System by and between Pinellas, Pasco, Hillsborough, Tampa, St. Petersburg and WCRWSA dated August 6, 1992

(22) Interlocal Agreement for Meter Reporting Services for South Pasco Wellfield by and between St. Petersburg and WCRWSA dated April 19, 1993

(23) Agreement to Finance Regional System by and between Pinellas, Pasco, Hillsborough, Tampa, St. Petersburg and WCRWSA dated April 18, 1994

(24) Morris Bridge Surplus Water Supply Contract by and between WCRWSA and Tampa dated May 20, 1997

(25) Agreement by and between WCRWSA and Pinellas dated September 9, 1997

EXHIBIT H

SURVIVING AGREEMENTS

- (1) Clarification and Reaffirmation of and Assignment of St. Petersburg to the WCRWSA of Any and All Causes of Action in Connection with the Development and Construction of the Cypress Creek Transmission Main dated June 19, 1989
- (2) Clarification and Reaffirmation of and Assignment of Pinellas to the WCRWSA of Any and All Causes of Action in Connection with the Development and Construction of the Cypress Creek Transmission Main dated June 19, 1989
- (3) New Water Source Funding Agreement between SWFWMD and Tampa for the Tampa Water Resource Recovery Implementation Program (F009) dated May 21, 1995 and Amendment dated September 30, 1996 and Second Amendment dated November 6, 1997
- (4) Tampa/Hillsborough County Interconnect Water Supply Agreement by and between WCRWSA and Tampa dated January 21, 1998
- (5) Cooperative Agreement between SWFWMD and WCRWSA for Northwest Hillsborough Interconnect dated February 14, 1996.

EXHIBIT I

MODIFIED AGREEMENTS

(1) Morris Bridge Wellfield Agreement by and between SWFWMD, the Hillsborough River Basin Board and Tampa dated April 22, 1970

(2) Starkey Wellfield Agreement by and between SWFWMD and New Port Richey dated August 16, 1972

(3) Cypress Creek Wellfield Agreement by and between SWFWMD, SWFWMD (Regulatory), Pinellas, Pasco and St. Petersburg dated November 14, 1973

(4) Starkey Wellfield Agreement by and between SWFWMD and New Port Richey dated March 26, 1974 and Supplemental Agreement dated July 16, 1974

(5) Easement Agreement by and between SWFWMD and Tampa dated October 8, 1975

(6) Cypress Creek Wellfield Agreement by and between St. Petersburg and WCRWSA dated November 22, 1976

(7) Cypress Creek Wellfield Agreement by and between Pinellas and WCRWSA dated November 22, 1976

(8) Starkey Wellfield Addendum Agreement by and between SWFWMD and New Port Richey dated March 2, 1977

(9) Cypress Creek Wellfield Agreement by and between Pasco and WCRWSA dated March 22, 1977

(10) Starkey Wellfield Agreement by and between Pasco and New Port Richey dated August 31, 1978

(11) License Agreement for Cypress Creek Wellfield between SWFWMD, Hillsborough River Basin Board, Pinellas-Anclote River Basin Board and WCRWSA dated July 10, 1979.

(12) Cross Bar Ranch Wellfield Agreement by and between Pinellas and WCRWSA dated November 8, 1977

(13) Water Transfer and Management Agreement by and between SWFWMD, New Port Richey and WCRWSA dated December 15, 1981

(14) South Pasco Wellfield License Agreement between St. Petersburg and SWFWMD dated October 9, 1989.

(15) Cypress Creek Wellfield License Agreement by and between SWFWMD and St. Petersburg dated March 18, 1991 and First Amendment dated March 1, 1993

(16) Starkey Wellfield License Agreement by and between SWFWMD and WCRWSA dated May 17, 1993

(17) New Water Source Funding between WCRWSA and Tampa for the Tampa Water Resource Recovery Implementation Program (F009) dated June 19, 1995 and Amendment dated September 30, 1996

EXHIBIT J

SUPERSEDED AGREEMENTS

(1) Interlocal Agreement by and between Tampa and Hillsborough dated June 26, 1979

(2) Section 6 of the Interlocal Agreement by and between Hillsborough and WCRWSA for Financing the Acquisition of the Cone Ranch dated February 17, 1988

EXHIBIT K

FORM OF ANNUAL REPORT

A. SHORT TERM FORECAST

Water Service demand for the next five (5) fiscal years at each of your delivery points and any proposed new delivery points.

1. Average Daily Flow Rates
2. Maximum/Peak Daily Flow Rates
3. Maximum/Instantaneous/Peak Hour Flow Rates (if applicable)
4. Pressure (PSI)
5. Water System Storage Capacity (mg)

B. LONG TERM FORECAST

Anticipated Water Service demand for the next twenty (20) fiscal years at each of your delivery points and any proposed new delivery points (in five year increments).

1. Average Daily Flow Rates
2. Maximum/Peak Daily Flow Rates
3. Maximum/Instantaneous/Peak Hour Flow Rates (if applicable)
4. Pressure (PSI)
5. Water System Storage Capacity (mg)

C. SUPPORTING OPERATIONAL INFORMATION

Please indicate any changes that have or may occur to the following, and provide maps of the changes if available (hard-copy or digital).

1. Points of Connection (including connections with other member governments)
2. Pumping Station/Water Treatment Plant (Facility) Information

D. SUPPORTING PLANNING INFORMATION

Please provide the following data in total and for each of your water service areas (demand planning areas).

1. Per Capita Use
2. Water Conserving Rate Structure
3. Water Audit Program
4. Residential Water Use
5. Reclaimed Water Use
6. Population Estimates (functional service population)
7. Changes to Service Area boundaries (text description and map)

EXHIBIT K

FORM OF ANNUAL REPORT

EXHIBIT L

ARBITRATION DISCOVERY RULES

EXHIBIT L**Discovery Rules for Binding Arbitration****Rule 1: Prehearing Procedure**

- (a) **Arbitration Management Conference.** At any time after the Chair of the Arbitration Panel (hereinafter "Chair") is selected, a party, by serving notice upon the Chair and the opposing party, may convene a case management conference. The matters to be considered shall be specified in the notice setting the conference. At such a conference the Chair may:
- (1) set or reset the time of the arbitration hearing;
 - (2) expand, schedule, order, or expedite discovery;
 - (3) schedule disclosure of expert witnesses and the discovery of facts known and opinions held by such experts;
 - (4) schedule or hear motions to exclude evidence on the grounds that a party did not comply with a request for discovery under these rules;
 - (5) pursue the possibilities of settlement;
 - (6) require filing of preliminary stipulations if issues can be narrowed; and
 - (7) schedule other conferences or determine other matters that may aid in the disposition of the dispute.
- (b) **Prehearing Conference.** Within sixty (60) days before the commencement of the arbitration hearing, a party, by serving a notice upon the Chair and the opposing party, may convene a prehearing conference. At such a conference the Chair shall consider and determine:
- (1) the simplification of the issues;
 - (2) the necessity or desirability of amendments to the Host Member Government's objection or to the Authority's proposed permit application;
 - (3) the possibility of obtaining admissions of fact and of documents that will avoid unnecessary proof;
 - (4) the limitation of the number of expert witnesses; and
 - (5) any matters permitted under subdivision (a) of this rule.
- (c) **Notice.** Ten (10) days' notice shall be given for a arbitration management conference, and 10 days' notice shall be given for a prehearing conference. On failure of a party to attend a conference, the Chair may dismiss the arbitration and render a decision in favor of the non-offending party or it may limit proof or witnesses.
- (d) **Prehearing Order.** The Chair shall make an order reciting the action taken at a conference and any stipulations made. The order shall control the subsequent course of the action

unless modified to prevent injustice.

Rule 2: General Provisions Governing Discovery

- (a) **Discovery Methods.** Parties may obtain discovery by one or more of the following methods: depositions upon oral examination; written interrogatories; and production of documents or things or permission to enter upon land or other property for inspection and other purposes. Unless otherwise expanded by agreement of the parties, the frequency of use of these methods is limited as provided in rules 4, 6, and 7.
- (b) **Scope of Discovery.** The scope of discovery is as follows:
- (1) **In General.** Parties may obtain discovery regarding any matter, not privileged, that is relevant to the issuance, modification or renewal of any Primary Environmental Permit, including, but not limited to, the existence, description, nature, custody, condition, and location of any analyses, books, data, documents, memoranda, reports, tests, test results, or other tangible things and the identity and location of persons having knowledge of any discoverable matter. It is not ground for objection that the information sought would be inadmissible in an administrative hearing or a judicial enforcement hearing.
- (2) **Indemnity Agreements.** The Host Member Government may obtain discovery of the existence and contents of any agreement under which any person may be liable to satisfy part or all of a judgment that may be entered in the action or to indemnify or to reimburse a party for payments made to satisfy the judgment.
- (3) **Hearing Preparation: Materials.** Subject to the provisions of subdivision (b) (4) of this rule, a party may obtain discovery of documents and tangible things otherwise discoverable under subdivision (b) (1) of this rule and prepared in anticipation of the arbitration hearing or any pending or anticipated litigation by or for the opposing party or by or for the opposing party's representative, including, but not limited to, the opposing party's attorney, consultant, surety, indemnitor, insurer, or agent, provided that the mental impressions, conclusions, opinions, or legal theories of an attorney of the opposing party concerning the arbitration hearing or any pending or anticipated litigation shall be protected against disclosure.
- (4) **Hearing Preparation: Experts.** Discovery of facts known and opinions held by experts, otherwise discoverable under the provisions of subdivision (b) (1) of this rule and acquired or developed in anticipation of the arbitration hearing or any pending or anticipated litigation, may be obtained only as follows:
- (A)

- (iii) By interrogatories a party may require the opposing party to identify each person whom the opposing party expects to call as an expert witness at the arbitration hearing and to state the subject matter on which the expert is expected to testify, and to state the substance of the facts and opinions to which the expert is expected to testify and a summary of the grounds for each opinion. Failure to identify any expert witnesses as required or to otherwise comply with this subsection shall result in exclusion of that witnesses' testimony.
- (ii) Any person disclosed by interrogatories or otherwise as a person expected to be called as an expert witness at the arbitration hearing may be deposed in accordance with rule 4. Each expert witness so deposed shall be able to state his or her fully developed opinions regarding the issues about which he or she will be called to testify, except for opinions subsequently developed to rebut the expert opinions of the opposing party's expert witnesses, in which case those subsequently developed rebuttal opinions must be disclosed as required by rule 2(d).
- (iii) A party may obtain the following discovery regarding any person disclosed by interrogatories or otherwise as a person expected to be called as an expert witness at the arbitration hearing:
1. The scope of employment in the pending matter and the compensation for such service.
 2. The expert's general litigation experience, including the percentage of work performed for the Authority or any Member Government.
 3. The identity of other matters, within a reasonable time period, in which the expert has testified by deposition, at hearing or at trial.
 4. An approximation of the portion of the expert's involvement as an expert witness, which may be based on the number of hours, percentage of hours, or percentage of earned income derived from serving as an expert witness.

An expert may be required to produce financial and business records only under the

most unusual or compelling circumstances and may not be compelled to compile or produce nonexistent documents. Upon motion, the chair may order further discovery by other means, subject to such restrictions as to scope and other provisions pursuant to subdivision (b) (4) (C) of this rule concerning fees and expenses as the chair may deem appropriate.

- (B) A party may discover facts known or opinions held by an expert who has been retained or employed by the opposing party, including, but not limited to, those specifically retained or employed with regard the issuance, modification or renewal of a Primary Environmental Permit or in anticipation of the arbitration hearing or any pending or anticipated litigation, and who is not expected to be called as a witness at the arbitration hearing.
- (C) As used in these rules an expert shall be an expert witness as defined in rule 9(a).
- (5) Claims of Privilege or Protection of Trial Preparation Materials. When a party withholds information otherwise discoverable under these rules by claiming that it is privileged or subject to protection, the party shall make the claim expressly and shall for each document or item so withheld identify the following:
 - (A) The type of document or information;
 - (B) The date on which it was prepared;
 - (C) The author;
 - (D) The identity of all persons shown as having seen or received a copy of the document;
 - (E) The subject matter of the document; and
 - (F) The privilege or exception to discovery upon which withholding is based.

- (c) Sequence and Timing of Discovery. The methods of discovery may be used in any sequence.
- (d) Supplementing of Responses. Once a party has responded to a request for discovery with a response that was complete when made, it is under a continuing duty to supplement the response to include information thereafter acquired.

Rule 3: Persons Before Whom Depositions May Be Taken

- (a) Persons Authorized. Depositions may be taken before any notary public or any officer authorized by the statutes of Florida to take acknowledgments or proof of executions of deeds.

- (b) Persons Disqualified. No deposition shall be taken before a person who is an employee, attorney, or counsel of any party or that is a relative or employee of any parties' attorney or counsel.

Rule 4: Depositions Upon Oral Examination

- (a) When Depositions May Be Taken. At any time after ten (10) days from the selection of the Chair, a party may take the testimony of any person by deposition upon oral examination. However, the Host Member Government may take depositions prior to ten (10) days after the selection of the Chair with the approval of a majority of the Authority's Board of Directors. Each party is entitled to take up to ten (10) depositions. Each deposition shall not exceed eight (8) hours in duration, excluding time taken for breaks, without the consent of the opposing party's attorney. The attendance of witnesses may be compelled by subpoena as provided in rule 10.
- (b) Notice; Method of Taking; Production at Deposition.
- (1) A party may take the deposition of any person upon oral examination upon giving ten (10) days notice, in writing, to the opposing party. The notice shall state the time and place for taking the deposition and the name and address of each person to be examined, if known, and, if the name is not known, a general description sufficient to identify the person or the particular class or group to which the person belongs. If a subpoena duces tecum is to be served on the person to be examined the designation of the materials to be produced under the subpoena shall be attached to or included in the notice.
 - (2) For cause shown, the Chair may enlarge the number of depositions permitted by these rules or the time for taking the deposition.
 - (3) Any deposition may be recorded by videotape without leave of the Chair or stipulation of the opposing party, provided the deposition is taken in accordance with this subdivision.
 - (A) Notice. If a party intends to videotape a deposition, the party shall state in the notice that the deposition is to be videotaped and shall give the name and address of the operator.
 - (B) Stenographer. Videotaped depositions shall also be recorded stenographically.
 - (C) Procedure. At the beginning of the deposition, the officer before whom it is taken shall, on camera: (i) identify the persons present, (ii) state the date, and (iii) swear the witness.
 - (D) Custody of Tape and Copies. The attorney for the

- party taking the deposition shall take custody of and be responsible for the safeguarding of the videotape, shall permit the viewing of it by the opposing party, and, if requested, shall provide a copy of the videotape to the opposing party at the opposing party's expense.
- (E) Cost of Videotaped Depositions. The party taking the deposition shall bear the initial cost of videotaping.
- (4) The notice to a deponent may be accompanied by a request made in compliance with rule 7 for the production of documents and tangible things at the taking of the deposition. The procedure of rule 7 shall apply to the request.
- (5) In the notice, the party may identify the matters on which examination is requested. The opposing party shall designate one or more officers, managing agents, or other persons to testify on its behalf. The persons so designated shall testify about matters known or reasonably available to the organization. This subdivision does not preclude taking a deposition by any other procedure authorized in these rules.
- (c) Examination and Cross-Examination; Record of Examination; Oath; Objections. Examination and cross-examination of witnesses is specifically authorized. The officer before whom the deposition is to be taken shall put the witness on oath and shall personally, or by someone acting under the officer's direction and in the officer's presence, record the testimony of the witness. The testimony shall be taken stenographically. If requested by one of the parties, the testimony shall be transcribed at the initial cost of the requesting party and prompt notice of the request shall be given to the other party. All objections made at time of the examination to the qualifications of the officer taking the deposition, the manner of taking it, the evidence presented, or the conduct of any party, and any other objection to the proceedings shall be noted by the officer upon the deposition. Any objection during a deposition shall be stated concisely and in a nonargumentative and nonsuggestive manner. A party may instruct a deponent not to answer only when necessary to preserve a privilege. Otherwise, evidence objected to shall be taken subject to the objections.
- (d) Witness Review. If the testimony is transcribed, the transcript shall be furnished to the witness for examination and shall be read to or by the witness unless the examination and reading are waived by the witness and by the parties. Any changes in form or substance that the witness wants to make shall be listed in writing by the officer with a statement of the reasons given by the witness for making

the changes. The changes shall be attached to the transcript. It shall then be signed by the witness unless the parties waived the signing or the witness is ill, cannot be found, or refuses to sign. If the transcript is not signed by the witness within ten (10) days after it is furnished to the witness, the officer shall sign the transcript and state on the transcript the waiver, illness, absence of the witness, or refusal to sign with any reasons given therefor. The deposition may then be used as fully as though signed.

(e) Exhibits.

- (1) If the deposition is transcribed, the officer shall certify on each copy of the deposition that the witness was duly sworn by the officer and that the deposition is a true record of the testimony given by the witness. Documents and things produced for inspection during the examination of the witness shall be marked for identification and annexed to and returned with the deposition upon the request of the party, and may be inspected and copied by the party, except that the person producing the materials may substitute copies to be marked for identification if that person affords to the party fair opportunity to verify the copies by comparison with the originals. If the person producing the materials requests their return, the officer shall mark them, give the party an opportunity to inspect and copy them, and return them to the person producing them and the materials may then be used in the same manner as if annexed to and returned with the deposition.
- (2) Upon payment of reasonable charges therefor the officer shall furnish a copy of the deposition to any party or to the deponent.

(f) Obtaining Copies. A party or witness who does not have a copy of the deposition may obtain it from the officer taking the deposition.

Rule 5: Use of Depositions in Binding Arbitration

(a) Use of Depositions. At the hearing, any part or all of a deposition may be used against either party who was present or represented at the taking of the deposition or who had reasonable notice as though the witness were then present and testifying in accordance with any of the following provisions:

- (1) Any deposition may be used by any party for the purpose of contradicting or impeaching the testimony of the deponent as a witness.
- (2) The deposition of anyone who at the time of taking the deposition was an officer, director, managing agent,

- consultant, employee of a party or a person designated under rule 4(b)(5) to testify on behalf of the party may be used by the opposing party for any purpose.
- (3) The deposition of a witness may be used by either party if the Chair finds:
- (A) That the witness is dead;
 - (B) That the witness is at a greater distance than 100 miles from the place of the hearing, or is out of the state, unless it appears that the absence of the witness was procured by the party offering the deposition;
 - (C) That the witness is unable to attend or testify because of age, illness, infirmity, or imprisonment;
 - (D) Upon application and notice, that such exceptional circumstances exist as to make it desirable, in the interest of justice and with due regard to the importance of presenting the testimony of witnesses orally in the hearing, to allow the deposition to be used; or
 - (E) The witness is an expert or skilled witness.
- (4) If only part of a deposition is offered in evidence by a party, the adverse party may require the party to introduce any other part that in fairness ought to be considered with the part introduced, and the other party may introduce any other parts.
- (b) **Objections to Admissibility.** Subject to the provisions of subdivision (d)(3) of this rule, objection may be made at the hearing to receiving in evidence any deposition or part of it for any reason that would require the exclusion of the evidence if the witness were then present and testifying.
- (c) **Effect of Taking or Using Depositions.** A party does not make a person it's own witness for any purpose by taking the person's deposition or by introducing into evidence the deposition or any part of it. At the hearing, the either party may rebut any relevant evidence contained in a deposition whether introduced by that party or by the other party.
- (d) **Effect of Errors and Irregularities.**
- (1) **As to Notice.** All errors and irregularities in the notice for taking a deposition are waived unless written objection is served upon the opposing party and the Chair within five (5) days of receipt of said notice.
 - (2) **As to Disqualification of Officer.** Objection to taking a deposition because of disqualification of the officer before whom it is to be taken is waived unless made before the taking of the deposition begins or as soon thereafter as the disqualification becomes known or

- could be discovered with reasonable diligence.
- (3) As to Taking of Deposition.
- (A) Objections to the competency of a witness or to the competency, relevancy, or materiality of testimony are not waived by failure to make them before or during the taking of the deposition unless the ground of the objection is one that might have been obviated or removed if presented at that time.
- (B) Errors and irregularities occurring at the oral examination in the manner of taking the deposition, in the form of the questions or answers, in the oath or affirmation, or in the conduct of parties and errors of any kind that might be obviated, removed, or cured if promptly presented are waived unless timely objection to them is made at the taking of the deposition.
- (4) As to Completion and Return. Errors and irregularities in the manner in which the testimony is transcribed or the deposition is prepared, signed, certified, or otherwise dealt with by the officer under rule 4 are waived unless a motion to suppress the deposition or some part of it is made and served upon the chair and other party within five (5) days after the defect is, or with due diligence might have been, discovered.

Rule 6: Interrogatories to Parties

- (a) Procedure for Use. At any time after thirty (30) days from the date the Host Member Government provides the Authority with notice under Section 3.13(A) of the Amended and Restated Interlocal Agreement, a party may serve upon the other party written interrogatories to be answered by any officer or agent designated to answer the interrogatories on its behalf. The interrogatories shall not exceed 25, including all subparts, unless the Chair permits a greater number. Each interrogatory shall be answered separately and fully in writing under oath unless it is objected to, in which event the grounds for objection shall be stated and signed by the attorney making it. The party to whom the interrogatories are directed shall serve the answers and any objections within thirty (30) days after the service of the interrogatories. The party submitting the interrogatories may move the Chair for an order under rule 8 on any objection to or other failure to answer an interrogatory.
- (b) Scope; Use at Hearing. Interrogatories may relate to any matters that can be inquired into under rule 2(b), and the answers may be used to the extent that they are relevant and material. An interrogatory otherwise proper is not objectionable merely because an answer to the interrogatory

involves an opinion or contention that relates to fact or calls for a conclusion or asks for information not within the personal knowledge of the party. A party shall respond to such an interrogatory by giving the information the party has and the source on which the information is based. If a party introduces an answer to an interrogatory, the other party may require that party to introduce any other interrogatory and answer that in fairness ought to be considered with it.

- (c) Service and Filing. Interrogatories shall be arranged so that a blank space is provided after each separately numbered interrogatory. The space shall be reasonably sufficient to enable the answering party to insert the answer within the space. If sufficient space is not provided, the answering party may attach additional papers with answers and refer to them in the space provided in the interrogatories. The original or any copy of the answers to interrogatories may be filed by any party when the arbitration panel should consider the answers to interrogatories in rendering a decision. The Chair may order a copy of the answers to interrogatories filed at any time when the chair determines that examination of the answers to interrogatories would assist the arbitration panel in rendering a decision.

Rule 7: Production of Documents and Things and Entry Upon Land for Inspection and Other Purposes

- (a) Request; Scope. A party may request the opposing party (1) to produce and permit the party making the request to inspect and copy any designated documents, including, but not limited to, analyses, books, charts, data, documents, drawings, graphs, memoranda, photographs, phono-records, and other data compilations, reports, tests, test results, writings, or other tangible things from which information can be obtained, translated, if necessary, by the opposing party through detection devices into reasonably usable form, that constitute or contain matters within the scope of rule 2(b) and that are in the possession, custody, or control of the opposing party or any person employed, retained or contracted by the opposing party; (2) to inspect and copy, test, or sample any tangible things that constitute or contain matters within the scope of rule 2(b) and that are in the possession, custody, or control of the opposing party or any person employed, retained or contracted by the opposing party; or (3) to permit entry upon designated land or other property in the possession or control of the opposing party or any Member Government for the purpose of inspection and measuring, surveying, photographing, testing, or sampling the property or any designated object or

operation on it within the scope of rule 2(b).

- (b) Procedure. At any time after thirty (30) days from the date the Host Member Government provides the Authority with notice under Section 3.13(A) of the Amended and Restated Interlocal Agreement, a party may serve the request upon the opposing party. The request shall set forth the items to be inspected, either by individual item or category, and describe each item and category with reasonable particularity. The request shall specify a reasonable time, place, and manner of making the inspection or performing the related acts. The party to whom the request is directed shall serve a written response within fifteen (15) days after service of the request. For each item or category the response shall state that inspection and related activities will be permitted as requested unless the request is objected to, in which event the reasons for the objection shall be stated. If an objection is made to part of an item or category, the part shall be specified. When producing documents, the producing party shall either produce them as they are kept in the usual course of business or shall identify them to correspond with the categories in the request. The party submitting the request may move for an order under rule 8 concerning any objection, failure to respond to the request, or any part of it, or failure to permit inspection as requested.
- (c) Persons Not Parties. This rule does not preclude an independent action against a person not a party for production of documents and things and permission to enter upon land.
- (d) Filing of Documents. Unless required by the chair, a party should not file any of the documents or things produced with the response. Documents or things may be filed when they should be considered by the arbitration panel in rendering a decision.

Rule 8: Failure to Make Discovery: Sanctions

- (a) Motion for Order Compelling Discovery. A party may apply to the Chair for an order compelling discovery as follows:
- (1) Motion. If a deponent fails to answer a question propounded or submitted under rule 4 or a party fails to make a designation under rule 4(b)(5), or if a party fails to answer an interrogatory submitted under rule 6, or if a party in response to a request for inspection submitted under rule 7 fails to respond that inspection will be permitted as requested or fails to permit inspection as requested, the discovering party may move the Chair for an order compelling an answer,

or a designation or an order compelling inspection in accordance with the request. The Chair shall make a final determination on the motion within five (5) business days. When taking a deposition on oral examination, the proponent of the question may complete or adjourn the examination before applying for an order.

- (2) Evasive or Incomplete Answer. For purposes of this subdivision an evasive or incomplete answer shall be treated as a failure to answer.
- (b) Failure to Comply With Order. If an officer, managing agent, employee, consultant, or person designated under rule 4(b)(5) to testify on behalf of a party fails to obey an order to provide or permit discovery, including an order made under subdivision (a) of this rule, the Chair shall make the following orders:
- (1) An order that the matters regarding which the questions were asked or any other designated facts shall be taken to be established for the purposes of the arbitration hearing in accordance with the position of the party obtaining the order; and
 - (2) An order refusing to allow the disobedient party to support or oppose designated positions and prohibiting that party from introducing designated matters in evidence.

- In addition, the Chair may dismiss the arbitration and render a judgment by default against the disobedient party.
- (c) Failure of Party to Attend Deposition or Serve Answers to Interrogatories or Respond to Request for Inspection. If an officer, managing agent, employee, consultant, or person designated under rule 4(b)(5) to testify on behalf of a party fails (1) to appear before the officer who is to take the deposition after being served with a proper notice, (2) to serve answers or objections to interrogatories submitted under rule 6 after proper service of the interrogatories, or (3) to serve a written response to a request for inspection submitted under rule 7 after proper service of the request, the Chair may, except as otherwise provided for in these rules, take any action authorized under subdivision (b) of this rule.

Rule 9: Depositions of Expert Witnesses

- (a) Definition. The term "expert witness" as used herein applies exclusively to a person duly and regularly engaged in the practice of a profession who holds a professional degree from a university or college and has had special professional training and experience, or one possessed of special knowledge or skill about the subject upon which called to testify.

- (b) Procedure. The testimony of an expert or skilled witness may be taken at any time before the arbitration hearing in accordance with the rules for taking depositions and may be used at the arbitration hearing, regardless of the place of residence of the witness or whether the witness is within the distance prescribed by rule 5(a)(3). Each expert witness deposed shall be able to state his or her fully developed opinion regarding the issues about which he or she will be called to testify, except for opinions subsequently developed to rebut the expert opinions of the opposing party's expert witnesses, in which case those subsequently developed rebuttal opinions must be disclosed as required by rule 2(d). The failure of an expert witness to have fully developed opinions by the date he or she is deposed shall result in the exclusion of that expert witnesses' testimony to the extent that such opinions are not fully developed. No special form of notice need be given that the deposition will be used for the arbitration hearing.
- (c) Applicability. Nothing in this rule shall prevent the taking of any deposition as otherwise provided by these rules.

Rule 10: Subpoena

Pursuant to Section 682.08, Florida Statutes, the Chair of the Arbitration Panel shall have the power to issue subpoenas for the attendance of witnesses and for the production of books, records, documents and other evidence, and shall have the power to administer oaths.